

Price List exc. VAT



January 2014





This price list is intended to give comprehensive price information on all systems and on all components used with them. Its format follows that of the main Silent Gliss catalogue. Accessories usable with any given system should appear underneath that system.

Index



Hand Operated Curtain Tracks, Picture Hanging

Systems 1011, 1012, 1021/1025, 1080, 1090, 1200, 1221, 1225, 1280, 3600, 3840, 6243, 6021, 6290
Pages: 2-7



Cord Operated Curtain Tracks, Heavy Duty/Stage Curtain Tracks

Systems 3000, 3840, 3900, 6200, 6370
Pages: 8-10



Pole Systems

Systems 1003M, 6100M, 6120M, 6130M, 6140M, 6150M, 6160M
Pages: 11-19



Room Divider Systems, Cubicle, Shower, Safety Device System

Systems 1085, 6100, 6103, 6650
Pages: 20-21



Electrically Operated Curtain Tracks

Systems 5090, 5090IR, 5090TL, 5090TC, 5200, 5220, 5400, 5420, 5300, 5800
Pages: 22-25



Switches, Remote Control and Multiple Operation of Motorised Systems

Systems 0450, 0900, 9940
Page: 26



Roman, Austrian, Festoon Blind Systems

Systems 2020, 2120, 2320, 2330, 2350, Made-to-measure Roman Blinds
Pages: 27-29



Sliding Panel Systems

Systems 2600, 2640, 2650, 2700, 2730, 2760
Page: 30-31



Skylight Systems

Systems 2190, 2195, 8600, 8700, 8800
Page: 32-35



Vertical Blinds

Systems 2810, 2900, 2950
Pages: 36-42



Roller Blinds

Systems 4900, 4910, 4830, 4840, 4960, 4870, 4880, Application chart
Pages: 43-53



Dim-Out Blinds

Systems 4500, 4510, 4540, 4550, 4590, 4595
Pages: 54-58



Venetian Blinds

Systems 8100, 8110 (15mm), 8110PC (25mm), 8250, 8300, 8900, 8950
Pages: 59-70



Plissée Pleated Blinds

System 8500
Pages: 71



Digital Printing/Wave® Standard, Wave XL Curtains

Page: 72-73



Parts Index/Tools & Packaging/Application Chart for switches, remote control and multiple operation of motorised systems/Conditions of Sale

Pages: 74-96

Prices

Prices are maximum recommended, not including VAT. Trade discounts applicable vary with product group as detailed below. Each system and item is designated as belonging to one of the following groups:-

Product Group A 1003, 1011, 1012, 1021, 1025, 1080, 1085, 1090, 1200, 1221, 1225, 1280, 2020, 2100, 2120, 2320, 2330, 3000, 3600, 3840, 3900, 5070, 5090, 5090R, 5090TL, 5090TC, 6021, 6100, 6103, 6140, 6109, 6120, 6130, 6150* 6290, 6243, 6650, made to measure Roman blinds.

Product Group C 0450, 2150, 2190, 2195, 2350, 2600, 2640, 2650, 2700, 2730, 2760, 2810, 2900, 2950, 4140, 4240, 4250, 4500, 4510, 4540, 4550, 4560, 4570, 4580, 4590, 4595, 4830, 4840, 4870, 4880, 4900, 4910, 4960, 5300, 5400, 5420, 5800, 6150†, 6200, 6370, 8100, 8110, 8250, 8300, 8500, 8600, 8700, 8800, 8900, 8950, 9940.

Silent Gliss Fabrics, Laminated blinds.

Product Group E Tools, Promotional material.

* 5090 versions † 5200 & 5400 versions

Coloured Tracks

Where the profile/components applicable are normally held in stock in certain colours, then these colours are indicated and priced accordingly on the relevant system page. Where the profile/components are not held in stock and are coloured to order then charges are as shown below. Any UK powder manufacturer's standard/stock RAL or BS colour may be matched by spraying (do not bend profile after it has been sprayed and also note max length 6m). Nylon components sprayed to colour match may sustain damage in the future.

Delivery: 4 weeks. Set-up charge: £199.86 net. Thereafter add following net amount to the net buying price for silver finish shown under the relevant system: £5.63 per metre net for all profiles **plus where applicable** £7.52 net per set end covers/wall supports/end pieces/cord guides, etc. Coloured extension brackets: £6.18 per bracket and cover for standard Metropole colours. Drilling to suit Metropole or for special spacing £3.09 per bracket.



Hand Operated Curtain Tracks

System 1011

Discreet system for recessing.
Supplied in satin silver finish as standard.
For colours see below – special order.
Track profile available in 6 metre lengths only. Supplied with endstop 3016 and one spring stop 3032 per length.



System 1012

Supplied in satin silver and bronze finish. For special colours – see below – special order. Profile available in 6 metre lengths only.
For fixing to concrete special support 3112 is used.

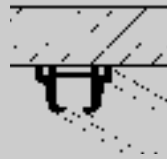

System Prices			Price Ctg.
Specific lengths charged at the nearest 25cm increment above.			A
cm	ft/ins	Silver	
125	4'1"	16.34	
150	4'11"	19.60	
175	5'8"	22.90	
200	6'6"	26.16	
225	7'4"	29.42	
250	8'2"	32.72	
275	9'0"	35.98	
300	9'10"	39.25	
325	10'8"	42.52	
350	11'5"	45.82	
375	12'4"	49.05	
400	13'1"	52.31	
425	13'11"	55.61	
450	14'9"	58.86	
475	15'7"	62.13	
500	16'4"	65.43	
525	17'2"	68.66	
550	18'0"	71.96	
575	18'10"	75.26	
600	19'8"	78.50	
Above prices are for systems ready-assembled. Substantial savings can be made for self-assembly. Rail can be supplied in full lengths or cut-to-size with accessories separately.			

Rail and Standard Accessories			Price Ctg.
1011 Rail, silver, available in 6m or cut-to-size.			A
3533 Glider at 16 per metre. Box, 100. Self-service sachets, 25 x 25. Outer, 25,000.			
3534 Glider, in strip form, at 16 per metre. Outer, 1,000 gliders.			
3019 Screw, 12mm/1/2" at 300mm centres, 100.			
3016 Endstop, each, 100.			
3032 Spring stop, 10, 100.			
7002 Rail protector, each, 10.			

All prices shown exclude VAT

Optional Accessories			Price Ctg.
3511 Glider, at 16 per metre, 100. Outer, 25,000 gliders.			A
3532 Glider. 100. Outer, 5,000.			
3570 Rotating glider, 100.			
3582 Hook. Box, 100. Self-service sachets, 25 x 25. Outer, 1,000. Outer, 20,000.			
3020 Hook. Metal, 100.			
3599 Hook. Box, 100 Self-service sachets, 25 x 25. Outer, 25,000.			
3571 Hook. Box, 100. Self-service sachets, 25 x 25. Outer, 35,000.			
3070 Twist eye endstop, each, 10.			
3025 Screw 18mm/3/4", 100.			
3562 Standard tape, 100 metres.			
3063 Connecting bridge, each.			
3071 Screw twist end stop, each.			
3548 Retrofit glider, 25,100, 1000.			
3068A Loop tape, 250 metres.			

10430 - 10434 Draw rods, white or aluminum			C
Colours Special order – see Page 1.			E
Tools			E
7030 Slotting tool.			
7100 Bending tool.			
7550 Centre fixing tool.			
7809 Filler set at 200cm.			
Bending			
	Max. trade discount	33 1/3%	
Angle bend, each £19.50			

System Prices			Price Ctg.
Specific lengths charged at the nearest 25cm increment above.			A
cm	ft/ins	To Wood	
		1012	1012 Bz
125	4'1"	15.88	21.34
150	4'11"	19.02	25.69
175	5'8"	22.22	29.92
200	6'6"	25.42	34.20
225	7'4"	28.58	38.47
250	8'2"	31.79	42.78
275	9'0"	34.95	47.01
300	9'10"	38.12	51.30
325	10'8"	41.29	55.55
350	11'5"	44.47	59.84
375	12'4"	47.66	64.12
400	13'1"	50.81	68.39
425	13'11"	53.98	72.68
450	14'9"	57.17	76.94
475	15'7"	60.36	81.21
500	16'4"	63.51	85.48
525	17'2"	66.67	89.80
550	18'0"	69.90	94.04
575	18'10"	73.06	98.29
600	19'8"	76.25	102.60

cm	ft/ins	To Concrete	
		1012	1012 Bz
125	4'1"	17.28	22.77
150	4'11"	20.75	27.33
175	5'8"	24.22	31.87
200	6'6"	27.66	36.42
225	7'4"	31.17	40.92
250	8'2"	34.60	45.53
275	9'0"	38.08	50.11
300	9'10"	41.49	54.61
325	10'8"	44.96	59.15
350	11'5"	48.40	63.90
375	12'4"	51.87	68.32
400	13'1"	55.36	72.83
425	13'11"	58.81	77.38
450	14'9"	62.27	81.97
475	15'7"	65.76	86.51
500	16'4"	69.16	91.03
525	17'2"	72.64	95.60
550	18'0"	76.10	100.17
575	18'10"	79.59	104.73
600	19'8"	83.01	109.25

Above prices are for systems ready-assembled. Substantial savings can be made for self-assembly. Rail can be supplied in full lengths or cut-to-size with accessories separately.

Rail and Standard Accessories			Price Ctg.
1012 Rail, silver or bronze, available in 6m or cut-to-size.			A
3533 Glider at 16 per metre. Box, 100. Self-service sachets, 25 x 25. Outer, 25,000.			
3534 Glider, in strip form, at 16 per metre. Outer, 1,000 gliders.			
3019 Screw, 12mm/1/2" at 300mm centres, 100.			
3016 Endstop, each, 100.			
3021 Screw raised head No. 6 for concrete fixing support.			
3112 Support for concrete fixing metal, 100.			
7002 Rail protector, each, 10.			

10430 - 10434 Draw rods, white or aluminum			C
Colours Other colours special order – see Page 1.			E
Tools			E
7030 Slotting tool.			
7100 Bending tool.			
7103 Portable hand operated bending tool.			
7109 Portable electrically operated bending tool.			
7550 Centre fixing tool.			
7809 Filler set at 200cm			
Bending			
	Max. trade discount	33 1/3%	
Angle bend, each £19.50			
Semi-circle or gradual curve, £26.00			
Arch, £49.50			



Hand Operated Curtain Tracks



Systems 1021/1025

Supplied in satin silver, white, bronze, gold anodised. For special colours see below – special order. Silver profile available in 5 and 6 metre lengths, white, bronze and gold in 6 metre lengths only.

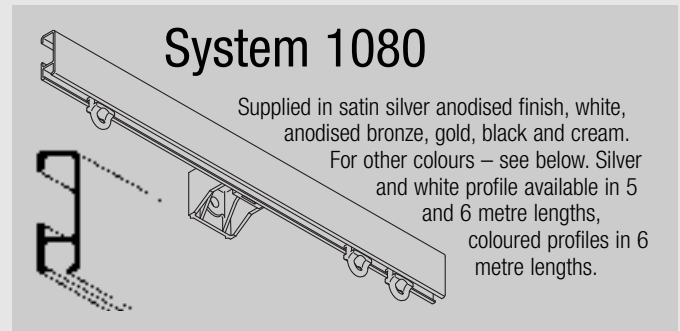

System 1080

Supplied in satin silver anodised finish, white, anodised bronze, gold, black and cream. For other colours – see below. Silver and white profile available in 5 and 6 metre lengths, coloured profiles in 6 metre lengths.

System Prices				Price Ctg.
Specific lengths charged at the nearest 25cm increment above.				A
cm	ft/ins	Silver	Bronze, Gold, White	
125	4'1"	12.58	20.49	
150	4'11"	15.12	24.61	
175	5'8"	17.62	28.68	
200	6'6"	20.12	32.75	
225	7'4"	22.65	36.87	
250	8'2"	25.17	40.92	
275	9'0"	27.67	45.03	
300	9'10"	30.21	49.16	
325	10'8"	32.73	53.25	
350	11'5"	35.24	57.34	
375	12'4"	37.72	61.44	
400	13'1"	40.28	65.53	
425	13'11"	42.81	69.61	
450	14'9"	45.30	73.68	
475	15'7"	47.82	77.86	
500	16'4"	50.33	81.92	
525	17'2"	52.86	86.01	
550	18'0"	55.40	90.11	
575	18'10"	57.88	94.22	
600	19'8"	60.41	98.29	
Above prices are for systems ready-assembled. Substantial savings can be made for self-assembly. Rail can be supplied in full lengths or cut-to-size with accessories separately.				

Rail and Standard Accessories		Price Ctg.
1021/1025 Rail, silver available in 5m and 6m or cut-to-size. White, bronze and gold available in 6m or cut-to-size.		A
3533 Glider at 16 per metre. Box, 100. Self-service sachets, 25 x 25. Outer, 25,000.		
3534 Glider, in strip form, at 16 per metre. Outer, 1,000 gliders.		
6835A Screw, 12mm/1/2" No. 4 round head at 300mm centres, 100.		
3016 Endstop, each, 100.		

All prices shown exclude VAT

Optional Accessories		Price Ctg.
3511 Glider, at 16 per metre, 100. Outer, 25,000 gliders.		A
3532 Glider. 100. Outer, 5,000.		
3570 Rotating glider, 100.		
3582 Hook, Box, 100. Self-service sachets, 25 x 25. Outer, 1,000. Outer, 20,000.		
3020 Hook. Metal, 100.		
3599 Hook. Box, 100. Self-service sachets, 25 x 25. Outer, 25,000.		
3032 Spring stop, 10, 100.		
3070 Twist eye endstop, each, 10.		
3071 Screw twist endstop, each, 10.		
3562 Standard tape, 100 metres.		
3580 Side mounted glider/hook, 100. Outer, 5,000.		
3571 Hook. Box, 100. Self-service sachets, 25 x 25. Outer, 35,000.		
6835B Screw 24mm/1", 100.		
3548 Retrofit glider, 25, 100, 1000.		
3068A Loop tape, 250 metres.		
10430 - 10434 Draw rods, white or aluminum		C

Colours		Price Ctg.
Other colours special order – see Page 1.		E
Tools		Price Ctg.
7030 Slotting tool		E
7100 Bending tool.		
7809 Filler set at 200cm		

Bending		Price Ctg.
Max. trade discount	33 1/3%	
Angle bend, each £27.50		

System Prices				Price Ctg.
Specific lengths charged at the nearest 25cm increment above.				A
cm	ft/ins	1080 W/S	1080 Bz/Gd/Bl/Cr	
125*	4'1"	18.60	28.63	
150*	4'11"	22.32	34.33	
175*	5'8"	26.03	40.08	
200*	6'6"	29.76	45.82	
225*	7'4"	33.45	51.54	
250*	8'2"	37.18	57.30	
275*	9'0"	40.90	62.96	
300	9'10"	44.64	68.67	
325	10'8"	48.32	74.45	
350	11'5"	52.10	80.16	
375	12'4"	55.77	85.90	
400	13'1"	59.47	91.60	
425	13'11"	63.21	97.32	
450	14'9"	66.93	103.07	
475	15'7"	70.62	108.79	
500	16'4"	74.37	114.49	
525	17'2"	78.06	120.22	
550	18'0"	81.79	125.97	
575	18'10"	85.51	131.66	
600	19'8"	89.20	137.43	
Above prices are for systems ready-assembled. Substantial savings can be made for self-assembly. Rail can be supplied in full lengths or cut-to-size with accessories separately.				

*1080W Packed in Acetate:
For sizes marked with an asterisk above we offer our 1080 in white only in clear acetate self-service display packaging. Prices are the same as indicated above. Min. order 12 lengths – mixed sizes/combined with 3000 system – and multiples of 12 thereafter.

Rail and Standard Accessories		Price Ctg.
1080 Rail, silver, white, in 5m & 6m, bronze, gold, black, cream in 6m.		A
3533 Glider Box, 100.		
Self-service sachets, 25 x 25. Outer, 25,000. Euroslot sachet 25.		
3534 Glider, in strip form, at 16/m.		
18R Screw 25mm/1". No. 8 round head, 100.		
3667 Endcover/stop, grey or white, each 10, 100. Euroslot sachet 2.		
3630 Universal nylon bracket, white at 600mm centres, each 10, 100. Euroslot sachet 2.		

Optional Accessories		Price Ctg.
3016 Endstop, each, 100.		A
3511 Glider, at 16 per metre, 100. Outer, 25,000 gliders.		
3570 Rotating glider, 100.		
3020 Hook. Metal, 100.		
3638 Reinforced corner piece for pelmets, each, 10.		
3603 Top fix brackets, white, each, 10, 100. Brown, gold, black, each 10.		
3548 Retrofit glider, 25, 100, 1000.		

System Prices		Price Ctg.
3630 Universal bracket, brown gold, each, 10.		A
3133 Extension bracket cover, white, 10, 100.		
3133L Long extension bracket cover, white, 10, 100.		
3571/3582/3599 Hooks - see under 1021/5.		
3070 Twist eye endstop, each, 10.		
1128R Screw 37mm/1 1/2", No. 8 round head, 100.		
3533/6146 Glider hook, 20.		
6146 Nylon hook, 12.		
3660 Extra long universal bracket.		
3655 Long universal bracket.		
3562 Standard tape, 100 metres.		
3615 Clamp.		
3620 Connecting bridge, each, 10.		
3602 Nylon wall support, grey, white, each, 10.		
3606 Snap fastener each, 10.		
3618 Metal wall support, each, 10.		
3626 Return fixing bracket, each.		
3639 Hanger rod assembly, 2' system complete.		
3648 Eyelet for 3638.		
Fixed Extension Brackets in Silver, White or Brown		
3134 2"/50mm 1 drilled & tapped hole. Each with 2 pre-drilled & tapped holes.		
3135 3"/75mm 3136 4"/100mm 3137 5"/125mm		
Each with 3 pre-drilled & tapped holes.		
3138 6"/150mm 3139 7"/200mm		
Adjustable extension brackets in Silver, White or Brown		
3275 7.7cm - 10.7cm		
3276 10cm - 13cm		
3277 13cm - 16cm		
0516 Clearance spacer (for top boards).		E
Colours		Price Ctg.
Other colours special order – see page 1.		E
Tools, etc		Price Ctg.
7030 Slotting tool.		E
7103 Portable hand operated bending tool.		
7109 Portable electrically operated bending tool.		
7806 Filler set for 1080 at 200cm for 7103/9.		
0540 Bending tool for gradual curves.		
Bending		Price Ctg.
Max. trade discount	33 1/3%	
Angle bend each £24.50		
Semi-circle or gradual curve £31.50		
Arch £59.50		
Note: Angle bends are only available from Wholesalers, Retail Support Specialists (RSS) and Distributors.		
3600 Picture Hanging System		Price Ctg.
Use prices for 1080 rail only and 3606 supports, covers 3605 where necessary plus special components below.		A
3637 Cord ø 1.5mm nom.		
3600 Picture hanging system complete (including 4x3663, cord 3637 & 3634 delrin height adjuster)		
3657 Connecting bridge for picture hanging system.		
3605 Endcover.		
See price index for individual prices		



Hand Operated Curtain Tracks

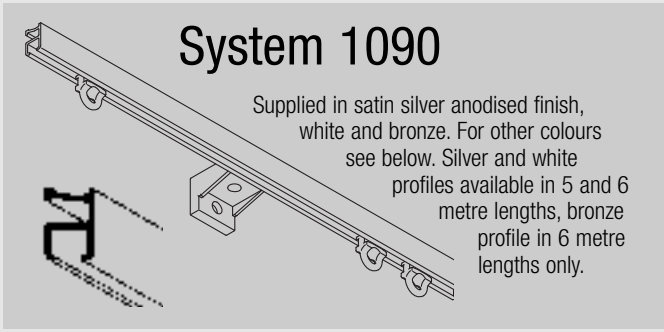

System 1090

Supplied in satin silver anodised finish, white and bronze. For other colours see below. Silver and white profiles available in 5 and 6 metre lengths, bronze profile in 6 metre lengths only.

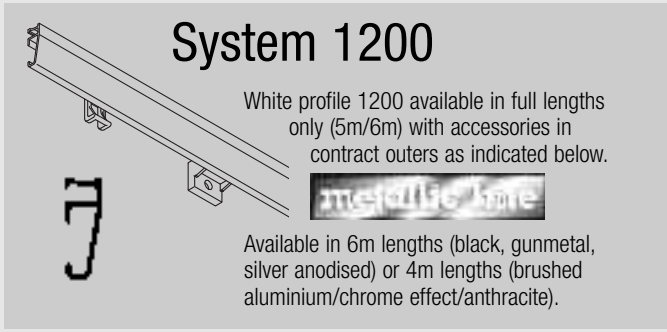

System 1200

White profile 1200 available in full lengths only (5m/6m) with accessories in contract outers as indicated below.



Available in 6m lengths (black, gunmetal, silver anodised) or 4m lengths (brushed aluminium/chrome effect/anthracite).

System Prices				Price Ctg.
cm	ft/ins	1090 W/S	1090 Bronze	A
125	4'1"	17.20	25.78	
150	4'11"	20.65	30.92	
175	5'8"	24.08	36.07	
200	6'6"	27.53	41.25	
225	7'4"	30.98	46.40	
250	8'2"	34.38	51.55	
275	9'0"	37.81	56.71	
300	9'10"	41.27	61.84	
325	10'8"	44.75	67.00	
350	11'5"	48.20	72.19	
375	12'4"	51.60	77.34	
400	13'1"	55.05	82.50	
425	13'11"	58.46	87.66	
450	14'9"	61.93	92.75	
475	15'7"	65.35	97.95	
500	16'4"	68.83	103.10	
525	17'2"	72.24	108.25	
550	18'0"	75.67	113.42	
575	18'10"	79.13	118.57	
600	19'8"	82.54	123.74	

Tracks between those specified will be charged at the nearest standard length above.

Above prices are for systems ready-assembled. Substantial savings can be made for self-assembly. Rail can be supplied in full lengths or cut-to-size with accessories separately.

Rail and Standard Accessories		Price Ctg.
1090 Rail, silver and white in 5m, 6m or cut-to-size; bronze in 6m or cut-to-size.		A
3533 Glider, Box, 100.		
Self-service sachets, 25 x 25.		
Outer, 25,000. Euroslot sachet 25.		
3534 Glider, in strip form, at 16 per metre.		
Outer, 1,000 gliders.		
18R Screw, 25mm/1", No. 8 round head, 100.		
3016 Endstop, each, 100.		
3175 Universal Nylon Bracket, white, 10, 100.		

Optional Accessories		Price Ctg.
3511 Glider, at 16 per metre, 100. Outer, 25,000 gliders.		A
3570 Rotating glider, 100.		
3582 Hook, 100. Self-service sachets, 25 x 25.		
Outer, 1,000. Outer, 20,000.		
3020 Hook, Metal, 100.		
3599 Hook, Box, 100. Self-service sachets, 25 x 25. Outer, 25,000.		
3176 Top fix bracket, white, 10, 100.		
3070 Twist eye endstop, each, 10.		
1128R Screw 37mm/1 1/2", No. 8 round head, 100.		
3133 Extension bracket cover, white, 10, 100.		
3548 Retrofit glider, 25, 100, 1000.		
Fixed Extension Brackets		
Each with 1 or 2 pre-drilled and tapped holes, in silver, white or brown:		
3134 2"/50mm (1) 3135 3"/75mm (2)		
3136 4"/100mm (2) 3137 5"/125mm (2)		
Each with 3 pre-drilled and tapped holes:		
3138 6"/150mm 3139 7"/200mm		

Adjustable extension brackets in Silver, White or Brown		Price Ctg.
3275 7.7cm-10.7cm		A
3276 10cm-13cm		
3277 13cm-16cm		
3562 Standard tape, 100 metres.		
3096 Connecting bridge, each, 10.		
3113 5cm metal spacer, 10, 100.		
3115 7cm metal spacer, 10, 100.		

10430 - 10434 Draw rods, white or aluminum		C
--	--	---

Colours		Price Ctg.
Other colours special order - see page 1.		E

Tools		Price Ctg.
Sleeving SL1090, SL1090W per reel.		E
7030 Slotting tool.		
7100 Bending tool.		
B4 Bending kit.		
7809 Filler set at 200cm, 2 required		

Bending		Price Ctg.
Angle bend £19.50 each.	Max. trade discount	33 1/3%
Semi-circle or gradual curve £26.00 each.		

System Prices				Price Ctg.
cm	ft/ins	1200 W/S	1200 Bl/Gm/ Ac/Ba/Ch	A
125	4'1"	17.28	25.56	
150	4'11"	20.75	30.67	
175	5'8"	24.22	35.77	
200	6'6"	27.66	40.86	
225	7'4"	31.14	45.99	
250	8'2"	34.60	51.07	
275	9'0"	38.08	56.21	
300	9'10"	41.50	61.27	
325	10'8"	44.96	66.44	
350	11'5"	48.40	71.50	
375	12'4"	51.88	76.64	
400	13'1"	55.36	81.71	
425	13'11"	58.81	86.85	
450	14'9"	62.27	91.96	
475	15'7"	65.71	97.09	
500	16'4"	69.17	102.17	
525	17'2"	72.66	107.27	
550	18'0"	76.10	112.37	
575	18'10"	79.61	117.49	
600	19'8"	83.01	122.60	

*Note: Chrome effect & Anthracite/Brushed Aluminium available up to 4m lengths only.

Rail and Standard Accessories

1200 Rail, white, available in 5m or 6m lengths, in outers of 10 lengths only.

1200 Available in 6m lengths, (Black/gunmetal, silver anodised) or 4m lengths (anthracite, brushed aluminium/chrome effect).

3933 'Click' glider in strip form, 14 per metre, outer of 1,000 gliders.

3986 Endcover, white, grey, dark grey or black, 10, 100.

3175 Universal nylon bracket, white, each, 10, 100.

Optional Accessories		Price Ctg.
3947 Pair of magnetic gliders, 10.		A
3942 Intermediate stop, 10.		
18R Screw 25mm/1", No. 8 round head, 100.		
3176 Top fix bracket, white, 100.		
3582 Hook, box 100, outer 1,000, outer 20,000.		
3599 Hook, box 100, outer 25,000.		
3562 Standard tape, 100m.		
3133 Extension bracket cover, white, black, gunmetal, silver, chrome, 10, 100.		
3133L Long extension bracket cover, white, 10, 100.		
Fixed extension brackets		
(For colours see index pages)		
3134 2"/50mm 1 drilled and tapped hole.		
Each with 2 pre-drilled and tapped holes:		
3135 3"/75mm 3136 4"/100mm		
3137 5"/125mm		
Each with 3 pre-drilled and tapped holes:		
3138 6"/150mm 3139 7"/200mm		
Each with 2 pre-drilled and tapped holes:		
3138 6"/150mm 3139 7"/200mm		
Adjustable extension brackets in white		
3275 7.7cm - 10.7cm.		
3276 10cm - 13cm.		
3277 13cm - 16cm.		

0516 Clearance spacer (for top boards), 100.		E
--	--	---

Colours		Price Ctg.
To special order - see Page 1.		E

Tools		Price Ctg.
7103 Portable hand operated bending tool.		E
7109 Portable electrically operated bending tool.		
0650 Bending kit for 7103/7109 incl. filler set, blocks, arms and rings.		

Bending		Price Ctg.
Angle bend £24.50 each	Max. trade discount	33 1/3%
Semi-circle or gradual curve £31.50		

Note: System 1200 White
Track and components sold only in contract quantities. System not available ready assembled or cut to length from Silent Gliss. We recommend Wholesalers, Retail Support Specialists (RSS) and Distributors who are able to offer the service. Recommended retail prices above are based on standard accessories detailed.

Angle bending of this system is only carried out by Wholesalers, Retail Support Specialists (RSS) and Distributors.

All prices shown exclude VAT



Hand Operated Curtain Tracks

System 1221

Supplied in full lengths only with accessories in outers as indicated below. White profile 1221 available in 5 metre or 6 metre lengths.

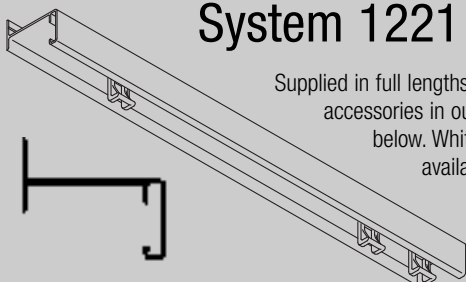

System 1225

Supplied in full lengths only with accessories in outers as indicated below. White profile 1225 available in 5 metre or 6 metre lengths.

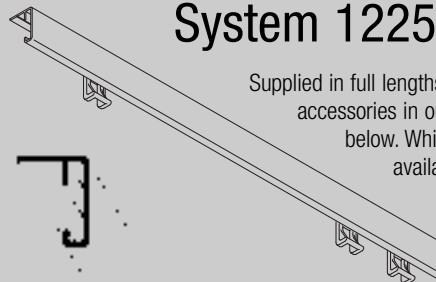

System Prices		Price Ctg.
	1221 (W)	A
cm	ft/ins	£
125	4'1"	15.80
150	4'11"	18.97
175	5'8"	22.13
200	6'6"	25.28
225	7'4"	28.45
250	8'2"	31.61
275	9'0"	34.79
300	9'10"	37.96
325	10'8"	41.13
350	11'5"	44.28
375	12'4"	47.43
400	13'1"	50.60
425	13'11"	53.79
450	14'9"	56.91
475	15'7"	60.11
500	16'4"	63.27
525	17'2"	66.45
550	18'0"	69.59
575	18'10"	72.75
600	19'8"	75.93

Note:
Track and components sold only in quantities indicated below. System not available ready assembled or cut to length from Silent Gliss. We recommend Wholesalers, Retail Support Specialists (RSS) and Distributors who are able to offer the service. Above recommended retail prices are based on standard accessories detailed below.

Rail and Standard Accessories	Price Ctg.
1221 White rail, available in 5m or 6m lengths, in outers of 10 lengths only.	A
3933 'Click' glider in strip form, 14 per metre, outer of 1000 gliders.	
3984 Endcover, white, 100.	

Optional Accessories	Price Ctg.
0688 Self-drilling wood screw (4.2 x 25mm), 100.	A
3947 Pair of magnetic gliders, 10.	
3942 Intermediate stop, 10.	
3582 Hook, box 100, outer 1,000, outer 20,000.	
3599 Hook, box 100, outer 25,000.	
3562 Standard tape, 100m.	

Colours	Price Ctg.
To special order – see Page 1.	E

Bending	Price Ctg.
Straight only.	

Rail and Standard Accessories	Price Ctg.
1225 White rail, available in 5m or 6m lengths, in outers of 10 lengths only.	A
3933 'Click' glider in strip form, 14 per metre, outer of 1,000 gliders.	
3984 Endcover, white, 100.	

System Prices		Price Ctg.
	1225	A
cm	ft/ins	W
125	4'1"	14.75
150	4'11"	17.71
175	5'8"	20.67
200	6'6"	23.62
225	7'4"	26.57
250	8'2"	29.51
275	9'0"	32.49
300	9'10"	35.41
325	10'8"	38.41
350	11'5"	41.34
375	12'4"	44.29
400	13'1"	47.27
425	13'11"	50.20
450	14'9"	53.16
475	15'7"	56.09
500	16'4"	59.05
525	17'2"	62.02
550	18'0"	64.98
575	18'10"	67.90
600	19'8"	70.85

Note:
Track and components sold only in quantities indicated below. System not available ready assembled or cut to length from Silent Gliss. We recommend Wholesalers, Retail Support Specialists (RSS) and Distributors who are able to offer the service. Above recommended retail prices are based on standard accessories detailed below.

Optional Accessories	Price Ctg.
16R Screw 25mm No. 6, round head, 100.	A
3947 Pair of magnetic gliders, 10.	
3942 Intermediate stop, 10.	
3582 Hook, box 100, outer 1,000, outer 20,000.	
3599 Hook, box 100, outer 25,000.	
3562 Standard tape, 100m.	

Colours	Price Ctg.
To special order – see Page 1.	E

Bending	Price Ctg.
Straight only.	

All prices shown exclude VAT



Hand Operated Curtain Tracks

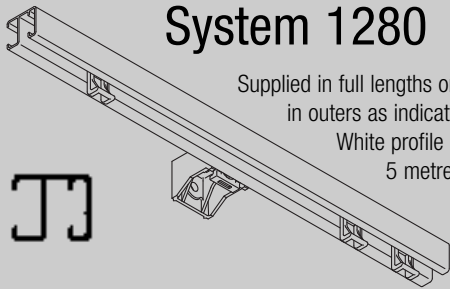

System 1280

Supplied in full lengths only with accessories in outers as indicated below.

White profile 1280 available in 5 metre or 6 metre lengths.

System 3840

3840 Hand Drawn is available with the Wave® Standard and Wave XL curtain heading systems. Top fixed as standard.

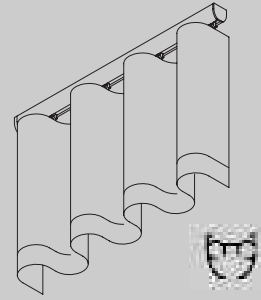

System Prices			Price Ctg.
1280 (W)			A
cm	ft/ins	£	
125	4'1"	28.30	
150	4'11"	34.01	
175	5'8"	39.61	
200	6'6"	45.29	
225	7'4"	50.93	
250	8'2"	56.59	
275	9'0"	62.27	
300	9'10"	67.90	
325	10'8"	73.58	
350	11'5"	79.23	
375	12'4"	84.90	
400	13'1"	90.57	
425	13'11"	96.19	
450	14'9"	101.88	
475	15'7"	107.56	
500	16'4"	113.18	
525	17'2"	118.84	
550	18'0"	124.52	
575	18'10"	130.19	
600	19'8"	135.83	

Note:
Track and components sold only in quantities indicated below. System not available ready assembled or cut to length from Silent Gliss. We recommend Wholesalers, Retail Support Specialists (RSS) and Distributors who are able to offer the service. Above recommended retail prices are based on standard accessories detailed below.

Rail and Standard Accessories		Price Ctg.
1280 White rail, available in 5m or 6m lengths, in outers of 10 lengths only.		A
3630 Universal nylon bracket, white, at 600mm centres, 100.		
3922 Roller glider in strip form at 10 per metre, outer of 1,000 gliders, outer of 6,000 gliders.		
3985 Eyelet endcover/endstop in white, 100.		
Optional Accessories		A
3620 Connecting bridge.		
3975 Overlap for pulling by hand, each, 10.		
3935A Combination overlap straight, complete with 'S' hook attachment 3949, each, 10.		
3936A Combination overlap complete with 'S' hook attachment 3949, each, 10.		
3947 Pair of magnetic gliders, 10.		
3942 Intermediate stop, 10.		
3603 Top fix bracket, white each, 10, 100.		
18R Screw 25mm/1", No. 8 round head, 100.		
3582 Hook, box 100, outer 1,000, outer 20,000.		
3599 Hook, box 100, outer 25,000.		
3562 Standard tape, 100m.		
3133 Extension bracket cover, white, 10, 100.		
3133L Long extension bracket cover, white, 10, 100.		
Fixed extension brackets in white.		
3134 2"/50mm 1 drilled and tapped hole. Each with 2 pre-drilled and tapped holes:		
3135 3"/75mm 3136 4"/100mm		
3137 5"/125mm		
Each with 3 pre-drilled and tapped holes:		
3138 6"/150mm 3139 7"/200mm		
Adjustable extension brackets in white		
3275 7.7cm - 10.7cm.		
3276 10cm - 13cm.		
3277 13cm - 16cm.		
0516 Clearance spacer (for top boards).		E
10430 - 10434 Draw rods, white or aluminum		C
Colours		E
To special order - see Page 1.		
Tools		E
7103 Portable hand operated bending tool.		
7109 Portable electrically operated bending tool.		
7220 Slotting tool.		
7844 Filler set for 7103/7109, 70cm.		
7844A Filler set for 0540, 200cm.		
0540 Bending tool for gradual curves		
Bending		33 1/3%
Max. trade discount		
Angle bend £24.50 each		
Semi-circle or gradual curve £31.50		
Note:		
Angle bending of this system is only carried out by Wholesalers, Retail Support Specialists (RSS) and Distributors.		

All prices shown exclude VAT

System Prices							Price Ctg.
System price including Wave supplement							A
		Using Standard Gliders		Using Roller Gliders			
cm	ft/ins	W/S	Bz/Gd/BI	W/S	Bz/Gd/BI	£	
125	4'1"	43.41	62.17	53.00	71.29		
150	4'11"	45.48	68.00	56.97	78.94		
175	5'8"	52.38	78.65	65.88	91.44		
200	6'6"	59.27	89.30	74.59	103.88		
225	7'4"	66.17	99.95	83.44	116.33		
250	8'2"	73.07	110.61	92.30	128.85		
275	9'0"	77.67	118.96	98.74	138.99		
300	9'10"	91.27	136.31	114.23	158.14		
325	10'8"	91.85	140.65	116.77	164.34		
350	11'5"	98.75	151.30	125.63	176.84		
375	12'4"	103.54	159.85	132.33	187.15		
400	13'1"	110.44	170.50	141.13	199.67		
425	13'11"	117.34	181.15	149.96	212.17		
450	14'9"	124.24	191.80	158.76	224.65		
475	15'7"	129.03	200.35	165.51	234.99		
500	16'4"	135.93	211.00	174.24	247.43		
525	17'2"	142.83	221.65	183.06	259.84		
550	18'0"	147.62	230.20	189.78	270.36		
575	18'10"	154.52	240.85	198.64	282.76		
600	19'8"	161.41	251.50	207.44	295.28		
Using Standard Wave Gliders							
		60mm glider cord		80mm glider cord			
cm	ft/ins	W/S	Bz/Gd/BI	W/S	Bz/Gd/BI	£	
125	4'1"	56.15	74.91	53.51	72.28		
150	4'11"	63.80	86.32	60.63	83.15		
175	5'8"	73.75	100.02	70.05	96.33		
200	6'6"	83.70	113.73	79.48	109.51		
225	7'4"	93.65	127.43	88.90	122.68		
250	8'2"	103.60	141.14	98.32	135.86		
275	9'0"	111.25	152.54	105.45	146.74		
300	9'10"	127.91	172.95	121.57	166.62		
325	10'8"	131.54	180.34	124.68	173.48		
350	11'5"	141.49	194.05	134.11	186.66		
375	12'4"	149.34	205.65	141.43	197.73		
400	13'1"	159.29	219.35	150.85	210.91		
425	13'11"	169.24	233.05	160.27	224.08		
450	14'9"	179.19	246.76	169.70	237.26		
475	15'7"	187.04	258.36	177.01	248.33		
500	16'4"	196.99	272.06	186.44	261.51		
525	17'2"	206.94	285.77	195.86	274.69		
550	18'0"	214.79	297.37	203.18	285.76		
575	18'10"	224.74	311.07	212.60	298.94		
600	19'8"	234.69	324.78	222.03	312.11		
Using Wave Roller Gliders							
		80mm glider cord					
cm	ft/ins	W/S	Bz/Gd/BI	£			
125	4'1"	96.73	115.03				
150	4'11"	109.45	131.42				
175	5'8"	127.10	152.67				
200	6'6"	144.56	173.85				
225	7'4"	162.16	195.05				
250	8'2"	179.76	216.31				
275	9'0"	194.95	235.20				
300	9'10"	219.18	263.10				
325	10'8"	230.48	278.04				
350	11'5"	248.08	299.29				
375	12'4"	263.53	318.34				
400	13'1"	281.07	339.61				
425	13'11"	298.65	360.86				
450	14'9"	316.19	382.09				
475	15'7"	331.69	401.17				
500	16'4"	349.16	422.36				
525	17'2"	366.73	443.62				
550	18'0"	382.20	462.78				
575	18'10"	399.80	483.93				
600	19'8"	417.36	505.19				
3840 Hand Operated Enhanced Wave®							
Add the following supplement to System prices above:							
Single-stack £31.98; Pair-stack £63.96							
3840 Hand Operated with Wave XL							
Price supplement of £47.94 per metre to standard glider price above.							
N.B. Please note that accessories may carry additional charges.							



Hand Operated Curtain Tracks

System 3840

System 6243

System 6290

System 6021

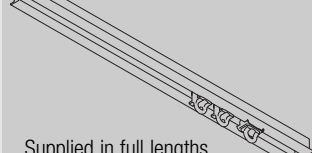

Supplied in full lengths only with accessories in outers as indicated below. White profile 6243 available in 5m lengths.

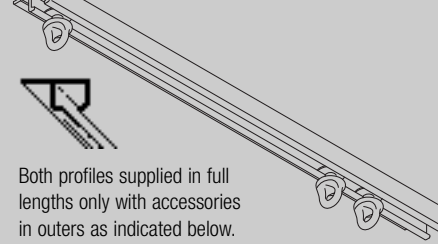

Both profiles supplied in full lengths only with accessories in outers as indicated below.

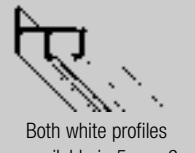

Both white profiles available in 5m or 6m lengths.

	Price Ctg.
Rail and Standard Accessories	A
3841 Rail, silver, white, bronze, gold and black available in 6m or cut-to-size.	
6345 Glider-cord 60mm pitch	
6346 Glider-cord 80mm pitch	
1148C Screw, 31mm/1 1/4", No. 8 countersunk, 100.	
Optional Accessories	A
(additional charges may apply).	
2255 Adjustable brake.	
3133 Extension bracket cover, white, 10, 100.	
3133L Long extension bracket cover, white, 10, 100.	
3582 Curtain hooks (each).	
3582 Hook, Box, 100. Self-service sachets, 25 x 25. Outer, 20,000.	
3802 Connecting bridge.	
3826W Nylon bracket, (top fix).	
3832 Clamp for top fixing.	
3836 Nylon bracket, (face fix).	
3842 Endcover.	
6349 Wave® curtain tape (per m).	
6364 Extension.	
6365 Hanger.	
6363 Iron-on hemming tape.	
6366 Draw rod carrier.	
10075 Lead curtain weight.	
10076 Fabric side weight.	
Extension Brackets with Rivetted Clamps 3825	
3275/3825	
3276/3825	
3277/3825	
Fixed Extension Brackets in silver, white or brown	
Each with 1 and 2 pre-drilled and tapped holes:	
3134 2"/50mm(1) 3135 3"/75mm(2)	
3136 4"/100mm(2) 3137 5"/125mm(2)	
Each with 3 pre-drilled and tapped holes	
3138 6"/150mm 3139 7"/200mm	
10430 - 10434 Draw rods, white or aluminum	C
Colours	E
Other colours special order – see page 1.	
Tools	E
0538 Bending kit for use with 7103/7109.	
7103 Portable hand operated bending tool.	
7109 Portable electrically operated bending tool.	
7802 Filler set 3840 at 200cm for 7103/9.	
Bending	33 1/3%
Max. trade discount	
Angle bend £37.50	
Semi-circle or gradual curve £50.00	

	Price Ctg.		
System Prices	A		
System price including Wave supplement			
	Standard Glider	Wave Glider 60mm	Wave Glider 80mm
cm	ft/ins	£	£
125	4'1"	25.46	40.99 52.41
150	4'11"	29.31	47.94 61.65
175	5'8"	33.16	54.90 70.88
200	6'6"	37.01	61.85 80.12
225	7'4"	40.85	68.80 89.36
250	8'2"	44.70	75.76 98.60
275	9'0"	48.55	82.71 107.84
300	9'10"	52.40	89.67 117.07
325	10'8"	56.25	96.62 126.31
350	11'5"	60.10	103.57 135.55
375	12'4"	63.95	110.53 144.79
400	13'1"	67.79	117.48 154.03
425	13'11"	71.64	124.44 163.26
450	14'9"	75.49	131.39 172.50
475	15'7"	79.34	138.34 181.74
500	16'4"	83.19	145.30 190.98
525	17'2"	87.04	152.25 200.22
550	18'0"	90.89	159.21 209.45
575	18'10"	94.73	166.16 218.69
600	19'8"	98.58	173.11 227.93
Rail and Standard Accessories	A		
6053 Spring Stop, 10.			
6243 White rail available in 6m lengths only.			
6096 Glider in Strip form. Outer 1,000.			
3025 Screw, 19mm, 100.			
Optional Accessories	A		
3067 Connecting bridge.			
Colours	E		
To special order – see page 1.			
Bending	33 1/3%		
Max. trade discount			
Angle bend £24.50			
Gradual curve £31.50			

	Price Ctg.	
System Prices	A	
	6290 (W)	
cm	ft/ins	£
125	4'1"	16.90
150	4'11"	20.28
175	5'8"	23.63
200	6'6"	27.01
225	7'4"	30.40
250	8'2"	33.75
275	9'0"	37.17
300	9'10"	40.51
325	10'8"	43.92
350	11'5"	47.29
375	12'4"	50.68
400	13'1"	54.04
425	13'11"	57.41
450	14'9"	60.80
475	15'7"	64.19
500	16'4"	67.54
525	17'2"	70.93
550	18'0"	74.31
575	18'10"	77.70
600	19'8"	81.06
System Prices		
a) Recommended Retail Prices for assembled systems.		
	Per metre	
6021 White (W)	£17.47	
	6021 (W)	
cm	ft/ins	£
125	4'1"	21.68
150	4'11"	26.02
175	5'8"	30.35
200	6'6"	34.67
225	7'4"	39.01
250	8'2"	43.34
275	9'0"	47.68
300	9'10"	51.98
325	10'8"	56.34
350	11'5"	60.70
375	12'4"	65.02
400	13'1"	69.36
425	13'11"	73.67
450	14'9"	78.02
475	15'7"	82.35
500	16'4"	86.70
525	17'2"	91.02
550	18'0"	95.35
575	18'10"	99.68
600	19'8"	104.03
Note:		
Track and components sold only in quantities indicated below.		
System not available ready assembled or cut to length from Silent Gliss. We recommend Wholesalers, Retail Support Specialists (RSS) and Distributors who are able to offer the service.		
Above recommended retail prices are based on standard accessories detailed below.		

	Price Ctg.
Rail and Standard Accessories	A
6290 White rail, available in 5/6m lengths, in outers of 10 lengths only.	
6122 Endstop, 100.	
6148 Glider at 10 per m, 1,000.	
6149 Lead glider (blue) at 2 per length, 100.	
Optional Accessories	A
0688 Self drilling wood screw, 100.	
3582 Hook, 100, 1,000, 20,000.	
3599 Hook, 100, 25,000.	
3562 Standard tape, 100m.	
10430 - 10434 Draw rods, white or aluminum	C
Colours	E
To special order – see Page 1.	
Bending	
Straight only.	
All prices shown exclude VAT	



Cord Operated Curtain Tracks

System 3000

Supplied in satin silver finish, gold, bronze, black, white and brushed aluminium. Profile only number is 1082. Silver and white profile available in 5 or 6 metre lengths, colour profile in 6 metre lengths. Brushed aluminium in 4 metre lengths only.

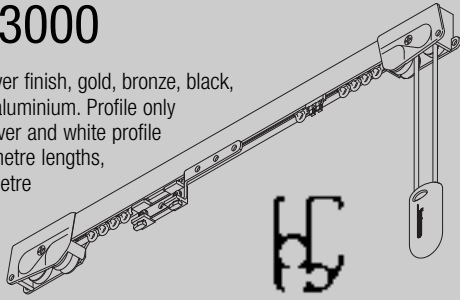

System 3840

Supplied in satin silver, white, bronze, gold and black. Available in 6 metre lengths only. 3840 is supplied with gliders 6083, 3840R is supplied with roller gliders 6283. Top fixed as standard.

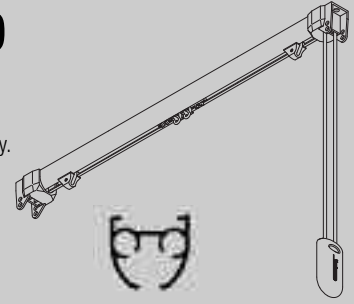

System Prices Price Ctg. A

cm	ft/ins	3000 W/S	3000 Bz/Gd/Bl/Ba
125	4'1"	72.54	90.86
150	4'11"	77.56	98.72
175	5'8"	82.60	106.51
200	6'6"	87.68	114.37
225	7'4"	92.68	122.16
250	8'2"	97.74	130.00
275	9'0"	102.78	137.83
300	9'10"	107.81	145.66
325	10'8"	112.83	153.45
350	11'5"	117.85	161.30
375	12'4"	122.94	169.10
400	13'1"	127.97	176.91
425	13'11"	133.01	184.72
450	14'9"	138.01	192.56
475	15'7"	143.10	200.39
500	16'4"	148.12	208.22
525	17'2"	153.15	216.05
550	18'0"	158.20	223.89
575	18'10"	163.23	231.69
600	19'8"	168.26	239.52

Note: Brushed aluminium available up to 4m lengths only.

Acetate display packaging (For min. quantities see 1080 page.)

cm	ft/ins	3000W
125	4'1"	72.54
150	4'11"	77.55
175	5'8"	82.59
200	6'6"	87.68
225	7'4"	92.67
250	8'2"	97.73
275	9'0"	102.96
300	9'10"	107.81

Track lengths between those specified will be charged at the rate for the nearest standard length above. 3242 overlap arm standard. Right hand pull as standard.

Above prices are for systems ready-assembled. Substantial savings can be made for self-assembly. Rail can be supplied in full lengths or cut-to-size with accessories separately.

Rail and Standard Accessories Price Ctg. A

1082 Rail, brushed aluminium in 4m or cut-to-size, silver and white in 5m, 6m or cut-to-size, bronze, gold & black in 6m or cut-to-size.
3533 Glider. Box, 100. Self-service sachets, 25 x 25. Outer, 25,000. Euroslot sachet 25.
3534 Glider, in strip form, 16 per metre. Outer, 1,000 gliders.
18R Screw 25mm/1", No. 8 round head, 100.
3630 Universal bracket, white, each, 10, 100, Euroslot sachet 2.

System Prices Price Ctg. A

3242 Overlap, each, 10, 100. Euroslot sachet 1.
3288 Pair of endpieces, including Pilot runners 3030/3213, grey, white, black, brown, gold. Outer, 25 sets, per set.
3090 Cord 100, metres, 500 metres.
3070 Twist eye endstop, each 10.
1348R Screw round head No. 8 44mm/1 3/4" for spacer 1105, 100.
1105 Spacer for cord pull end.

10400 Cord retainer Price Ctg. E

Optional Accessories Price Ctg. A

3511 Glider, at 16 per metre, 100. Outer, 25,000 gliders.
3570 Rotating glider, 100.
3582 Hook. Box, 100 Self-service sachets, 25 x 25. Euroslot sachets 25. Outer, 1000. Outer, 20,000.
3020 Hook. Metal, 100.
3599 Hook. Box, 100. Self-service sachets, 25 x 25. Euroslot sachet 25. Outer, 25,000.
3571 Hook. Box 100. Self-service sachets, 25 x 25. Outer 35,000. Euroslot sachet 25.
3603 Top fix brackets, white at 600mm centres each, 100. Euroslot sachet 2.
1128R Screw 36mm/1 1/2", No. 8 round head, 100.
3289/3289W Set end pieces with return, including pilot runners, set.
3340 Cord weight, white, each, 10, 100.
3340 Cord weight grey, chrome, each, 10, 100.
3655 Long universal bracket.
3660 Extra long universal bracket.
3562 Standard tape, 100 metres.
3620 Connecting bridge, each.
3208 Intermediate pulley, white, grey, brown, black, gold, each, 10.
3045 Metal overlap arm, each, 10.
3231 End fixing bracket, each, 10.
3615 Clamp.
3032 Springstop, 10, 100.
3133 Extension bracket cover, white, 10, 100.
3133L Long extension bracket cover, white, 10, 100.
0516 Clearance spacer (for top boards). For Extension Brackets, see system 1080.

Colours Price Ctg. E

Other colours special order – see page 1.

Tools
SL3000 Reel, sleeving.
SL3000W Reel, sleeving.
7030 Slotting tool.
7103 Portable hand operated bending tool.
7004 Cording needle.
7109 Portable electrically operated bending tool.
Instruction leaflet.
7805 Filler set 3000 at 200cm for 7103/9.
0540 Bending tool for gradual curves.

Bending Max. trade discount 33 1/3%

Angle bend, each £29.00
Semi-circle or gradual curve £42.50
Note: Angle bends are only available from Wholesalers, Retail Support Specialists (RSS) and Distributors.

System Prices Price Ctg. A

cm	ft/ins	Using Standard Gliders		Using Roller Gliders	
		W/S	Bz/Gd/Bl	W/S	Bz/Gd/Bl
125	4'1"	70.06	90.46	79.65	100.05
150	4'11"	77.11	100.45	88.60	111.94
175	5'8"	84.09	110.42	97.59	123.92
200	6'6"	91.16	120.46	106.48	135.78
225	7'4"	98.20	130.45	115.47	147.72
250	8'2"	105.21	140.41	124.44	159.64
275	9'0"	112.26	150.44	133.33	171.51
300	9'10"	119.32	160.42	142.28	183.38
325	10'8"	126.28	170.42	151.20	195.34
350	11'5"	133.33	180.38	160.21	207.26
375	12'4"	140.36	190.41	169.15	219.20
400	13'1"	147.41	200.39	178.10	231.08
425	13'11"	154.41	210.37	187.03	242.99
450	14'9"	161.47	220.35	195.99	254.87
475	15'7"	168.48	230.35	204.96	266.83
500	16'4"	175.58	240.36	213.89	278.67
525	17'2"	182.59	250.34	222.82	290.57
550	18'0"	189.62	260.32	231.78	302.48
575	18'10"	196.63	270.36	240.75	314.48
600	19'8"	203.69	280.31	249.72	326.34

cm	ft/ins	Using Standard Wave Gliders		80mm glider cord	
		W/S	Bz/Gd/Bl	W/S	Bz/Gd/Bl
125	4'1"	85.59	105.99	81.47	101.87
150	4'11"	95.74	119.08	90.81	114.15
175	5'8"	105.83	132.16	100.07	126.40
200	6'6"	116.00	145.30	109.42	138.72
225	7'4"	126.15	158.40	118.74	150.99
250	8'2"	136.26	171.46	128.04	163.24
275	9'0"	146.42	184.60	137.37	175.55
300	9'10"	156.58	197.68	146.71	187.81
325	10'8"	166.65	210.79	155.95	200.09
350	11'5"	176.80	223.85	165.29	212.34
375	12'4"	186.94	236.99	174.60	224.65
400	13'1"	197.09	250.07	183.93	236.91
425	13'11"	207.20	263.16	193.21	249.17
450	14'9"	217.36	276.24	202.56	261.44
475	15'7"	227.48	289.35	211.85	273.72
500	16'4"	237.68	302.46	221.23	286.01
525	17'2"	247.80	315.55	230.52	298.27
550	18'0"	257.93	328.63	239.84	310.54
575	18'10"	268.05	341.78	249.13	322.86
600	19'8"	278.21	354.83	258.47	335.09

cm	ft/ins	Using Wave Roller Gliders	
		W/S	Bz/Gd/Bl
125	4'1"	123.38	143.78
150	4'11"	141.08	164.42
175	5'8"	158.81	185.14
200	6'6"	176.45	205.75
225	7'4"	194.19	226.44
250	8'2"	211.90	247.10
275	9'0"	229.54	267.72
300	9'10"	247.24	288.34
325	10'8"	264.90	309.04
350	11'5"	282.66	329.71
375	12'4"	300.34	350.39
400	13'1"	318.04	371.02
425	13'11"	335.72	391.68
450	14'9"	353.42	412.30
475	15'7"	371.14	433.01
500	16'4"	388.82	453.60
525	17'2"	406.49	474.24
550	18'0"	424.20	494.90
575	18'10"	441.92	515.65
600	19'8"	459.63	536.25

Track lengths between those specified will be charged at the rate for the nearest standard length above. Overlap arm 6032 is standard. Cord is right hand pull as standard.

Above prices are for systems ready-assembled. Substantial savings can be made for self-assembly. Rail can be supplied in full lengths or cut-to-size with accessories separately.

All prices shown exclude VAT



Cord Operated Curtain Tracks

System 3840

System 3900

Supplied in full lengths only with accessories in outers as indicated below.
White profile 3982 available in 5 metre or 6 metre lengths.

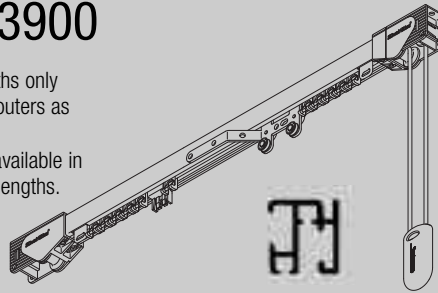

	Price Ctg.
Colours Other colours special order – see page 1.	E
Tools 7103 Portable hand operated bending tool. 7109 Portable electrically operated bending tool. 7802 Filler set 3840 at 200cm for 7103/9.	E
Enhanced Wave® System supplement per system £	
60mm Single-stack 27.25	
60mm Pair-stack 42.05	
80mm Single-stack 23.95	
80mm Pair-stack 38.77	
3840 with Wave XL Price supplement of £47.28 per metre.	
Rail and Standard Accessories	A
3841 Rail, silver, white, bronze, gold and black available in 6m or cut-to-size. 3090 Cord, 100 metres. 500 metres. 3825 Clamp at 30cm intervals, 10, 100. 3845 Endpiece set, white, grey, gold, black or brown. 1148C Screw, 31mm/1¼", No. 8 countersunk, 100. 6083 Gliders, Box, 100. Self-service sachets 25 x 25. 6096 Glider in strip form. Outer, 1,000. 6288 Plastic overlap arm, each, 10. 6283 Roller glider at 10 per metre, 10, 100. 6086 Spring stop, each 10, 100.	
10400 Cord retainer	E
Optional Accessories (additional charges may apply). 3020 Hook, Metal, 100. 3340 Cord weight, white, each, 10, 100. 3340 Cord weight grey, chrome, each, 10, 100. 3133 Extension bracket cover, white, 10, 100. 3133L Long extension bracket cover, white, 10, 100. 3562 Standard tape, 100 metres. 3571 Hook, Box 100. Self-service sachets, 25 x 25. Outer, 35,000. 3582 Curtain hooks (each). 3582 Hook, Box, 100. Self-service sachets, 25 x 25. Outer, 20,000. 3599 Hook, Box 100. Self-service sachets, 25 x 25. Outer, 25,000. 3802 Connecting bridge, each. 3826W Nylon bracket, (top fix). 3832 Clamp for top fixing. 3833A Intermediate pulley, white, each. 3836 Nylon bracket, (face fix). 3846 Endpieces set with return including pair of pilot runners and 2 x 3816 endpieces, white. 6063 Overlap arm, each, 10. 6094 Roller glider with hook, 10, 100. 6098 Roller glider with eye. 6345 Glider-cord 60mm pitch 6346 Glider-cord 80mm pitch 6349 Wave® curtain tape (per m). 6363 Iron-on hemming tape. 6365 Hanger. 6364 Extension. 6098W Roller glider cord 80mm. Extension Brackets with Rivetted Clamps 3825 3275/3825 3276/3825 3277/3825 Fixed Extension Brackets in silver, white or brown Each with 1 and 2 pre-drilled and tapped holes: 3134 2"/50mm(1) 3135 3"/75mm(2) 3136 4"/100mm(2) 3137 5"/125mm(2) Each with 3 pre-drilled & tapped holes 3138 6"/150mm 3139 7"/200mm	A
Bending Max. trade discount Angle bend £39.00 Semi-circle or gradual curve £50.00	331/3%

	Price Ctg.
System Prices	A
	3900(W)
cm ft/ins	£
125 4'1"	72.99
150 4'11"	80.15
175 5'8"	87.36
200 6'6"	94.50
225 7'4"	101.74
250 8'2"	108.90
275 9'0"	116.11
300 9'10"	123.30
325 10'8"	130.46
350 11'5"	137.66
375 12'4"	144.87
400 13'1"	152.03
425 13'11"	159.19
450 14'9"	166.41
475 15'7"	173.59
500 16'4"	180.79
525 17'2"	187.93
550 18'0"	195.16
575 18'10"	202.33
600 19'8"	209.47
Note: Track and components sold only in quantities indicated below. System 3900W not available ready assembled or cut to length from Silent Gliss. We recommend Wholesalers, Retail Support Specialists (RSS) and Distributors who are able to offer this service. Above recommended retail prices are based on standard accessories detailed below.	
Rail & Standard Accessories	A
3982W White rail, available in 5m or 6m lengths, in outers of 10 lengths only. 3630 Universal nylon bracket, white, at 600mm centres, 100. 3090 Cord, 100 metres, 500 metres. 3915 Endpiece set, incl. pilot runners 3939/3917, white, outer of 20 or 50 only. 3922 Roller glider in strip form at 10 per metre, outer of 1,000 gliders, outer of 6,000 gliders. 3936 Overlap arm, outer of 20 only.	
10400 Cord retainer	E
Bending Max. trade discount Angle bend £41.50 Semi-circle or gradual curve £59.50	331/3%

	Price Ctg.
Optional Accessories	A
3340 Cord weight, white, each, 10, 100. 3340 Cord weight grey, chrome, each, 10, 100. 3582 Hook, box 100, outer 1,000, outer 20,000. 3599 Hook, box 100, outer, 25,000. 3603 Top fix bracket, white, at 600mm centres, outer of 100. 18R Screw 25mm/1" No. 8 round head, 100. 3620 Connecting bridge, each. 3655 Long universal bracket. 3660 Extra long universal bracket, each. 3735 Cord tensioner with spring (required for hand operation on 3900 System) white, grey, each. 3914 Bracket for return profile, each. 3916 Pilot runner for multi stack system. 3929 Intermediate pulley, white, each 10. 3932 Spring stop, each 10. 3935 Straight overlap arm, each, 10. 3639 Hanger assembly complete, each. 3133 Extension bracket cover, white, 10, 100. 3133L Long extension bracket cover, white, 10, 100. 0516 Clearance spacer (for top boards). Fixed Extension brackets. Each with 1 or 2 pre-drilled and tapped holes, in white. 3134 2"/50mm(1) 3135 3"/75mm(2) 3136 4"/100mm(2) 3137 5"/125mm(2) Each with 3 pre-drilled and tapped holes in white. 3138 6"/150mm 3139 7"/200mm Adjustable extension brackets in White. 3275 7.7cm - 10.7cm. 3276 10cm - 13cm. 3277 13cm - 16cm.	
Colours To special order – see Page 1.	E
Tools 7103 Portable hand operated bending tool. 7109 Portable electrically operated bending tool. 0545 Bending kit for 7103/7109 including filler set, blocks, arms and rings. 7220 Slotting tool. 7803 Filler set for 7103/7109, 200cm. 0540 Bending tool for gradual curves.	E
Bending Max. trade discount Angle bend £41.50 Semi-circle or gradual curve £59.50	331/3%
Note: Bending of this system is only carried out by Wholesalers, Retail Support Specialists (RSS) and Distributors.	

All prices shown exclude VAT



Heavy Duty Curtain Tracks

System 6200

Supplied in satin silver as standard. Supplied with 6098 roller gliders, 6209 clamps and 6079 overlap arm as standard. Track available in 4, 5 and 6 metre lengths.

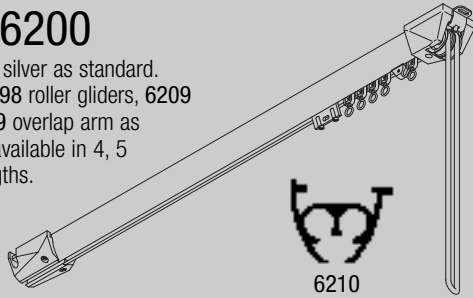

System 6370

Supplied in satin silver finish as standard. Profile available in 4, 5 and 6 metre lengths.

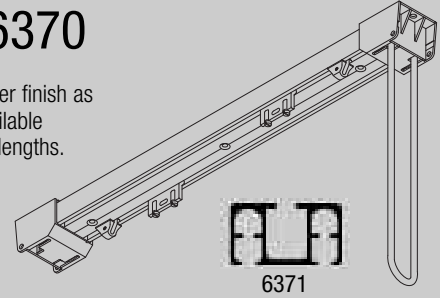

System Prices			Price Ctg.
a) Recommended retail prices for assembled systems.			C

cm	ft/ins	Standard Roller £	Wave Roller £
300	9'10"	529.12	622.30
350	11'5"	571.07	679.78
400	13'1"	611.86	736.10
450	14'9"	652.67	792.44
500	16'4"	693.42	848.72
550	18'0"	734.21	905.04
600	19'8"	775.04	961.40
650	21'4"	815.82	1017.71
700	23'0"	856.61	1074.03
750	24'7"	897.46	1130.41
800	26'2"	938.21	1186.69
850	27'10"	979.00	1243.01
900	29'6"	1019.82	1299.36
950	31'2"	1060.59	1355.66
1000	32'9"	1101.37	1411.97
1050	34'5"	1142.19	1468.32
1100	36'1"	1182.97	1524.63
1150	37'8"	1223.83	1581.02
1200	39'4"	1264.62	1637.34
1250	41'0"	1305.41	1693.66
1300	42'7"	1346.19	1749.97
1350	44'3"	1386.96	1806.27
1400	45'11"	1427.76	1862.60
1450	47'6"	1468.55	1918.92
1500	49'2"	1509.34	1975.24

For each additional 50cm add £43.48

Connecting bridge included over 6m. Right hand pull as standard.

For 2 tracks operated in parallel (System 6202), double price given above.

Above prices are for systems ready-assembled. Substantial savings can be made for self-assembly. Rail can be supplied in full lengths or cut-to-size with accessories separately.

Rail and Standard Accessories	Price Ctg.
6210 Silver rail available in 4m, 5, 6m or cut-to-size.	C
6209 Clamp, each, 10.	
6079 Overlap arm.	
6070 Cord 100 metres.	
6226 End support.	
6206 Endpiece set, each, 10.	
6007 Endstop, each 10.	
6098 Roller glider with eye, 10, 100.	
1128R Screw 36mm/1 1/2". No. 8 round head, 100.	
10400 Cord retainer	E

Special Lengths charged at the nearest 50cm increment above.

Special Lengths charged at the nearest 50cm increment above.

All prices shown exclude VAT

Optional Accessories			Price Ctg.
3239 Extension bracket.			C
5829 2-hole fixing plate.			
6098W Wave roller glider.			
6224 Nylon fixing clamp.			
6230 Mask.			
6575 Cord tensioner.			
6578 Floor plate.			
6203 Connecting bridge.			
6228 Double fixing plate.			
6190/6501 See 'Cubicle Track System 6100'.			
6190 Special Hanger Rod Assembly, silver.			
6501 Special 'V' Hanger Rod Assembly, silver.			
6214 Adjusted pilot runner.			
6227 Master pilot runner.			

6094 Roller glider with hook, 10, 100.		A	
Colours			E
Special order – see Page 1.			
Bending			25%
	Max. trade discount		
Standard right angle £99.50			
Semi-circle or gradual curve £294.00			
Tools			
7007 Demounting tool for 6224.			

System Prices			Price Ctg.
a) Recommended retail prices for assembled systems.			C

cm	ft/ins	£
6370S		
300	9'10"	293.75
350	11'5"	324.93
400	13'1"	356.18
450	14'9"	387.38
500	16'4"	418.60
550	18'0"	449.82
600	19'8"	481.06
650	21'4"	512.28
700	23'0"	543.47
750	24'7"	574.72
800	26'2"	605.90
850	27'10"	637.14
900	29'6"	668.35
950	31'2"	699.59
1000	32'9"	730.81
1050	34'5"	762.04
1100	36'1"	793.25
1150	37'8"	824.43
1200	39'4"	855.69
1250	41'0"	886.89
1300	42'7"	918.13
1350	44'3"	949.32
1400	45'11"	980.57
1450	47'6"	1011.77
1500	49'2"	1042.99

Connecting bridge included over 6m. Right hand pull as standard.

Above prices are for systems ready-assembled. Substantial savings can be made for self-assembly. Rail can be supplied in full lengths or cut-to-size with accessories separately.

Rail and Standard Accessories	Price Ctg.
6371 Silver rail available in 4m, 5m, 6m or cut-to-size.	C
6070 Cord.	
6214 Adjustable pilot runner.	
6227 Master pilot runner.	
6377 End piece set.	

28C Screw countersunk, No. 8 2"/50mm.	A
6086 Spring stop.	
6098 Roller glider with eye. 10 per metre.	

10400 Cord retainer	E

Special Lengths charged at the nearest 50cm increment above.

Special Lengths charged at the nearest 50cm increment above.

Optional Accessories			Price Ctg.
3239 Extension bracket.			C
6079 Overlap arm.			
6376 Connecting bridge.			
6575 Cord tensioner.			
6578 Floor plate.			

3599 Nylon hook.		A	
6283 Roller glider.			
6369 Insert (Face Fix).			
Colours			E
Special order – see Page 1.			
Bending			25%
	Max. trade discount		
Standard right angle £99.50			
Semi-circle or gradual curve £294.00			

System Prices			Price Ctg.
a) Recommended retail prices for assembled systems.			C

Special Lengths charged at the nearest 50cm increment above.



Pole Systems **Metropole** by *Silent Gliss*

Metropole by *Silent Gliss*

A decorative curtain pole concept combining beautifully crafted design details with contemporary finishes on our pole systems 1003/6120/6130 /6140/6150 and 6160.

All bent poles are supplied with adjustable brackets.

System 1003
hand operated,
Ø 23mm, can be bent
to a minimum radius of 15cm.

Metropole by Silent Gliss is based around our pole systems 1003/6130/6140 (hand drawn)/6120 (cord drawn)/6160 (cord drawn) and 6150 (electric). Select desired pole combination from our pole catalogue and find price below. Holdbacks are not included in prices below and need to be priced extra. See page 15.

1003 HAND DRAWN Ø 23mm – SILVER/BLACK/WHITE

Price Category A

Size	125 4'1"	150 4'11"	175 5'8"	200 6'6"	225 7'4"	250 8'2"	275 9'0"	300 9'10"	325 10'8"	350 11'5"	375 12'4"	400 13'1"	425 13'11"	450 14'9"	475 15'7"	500 16'4"	525 17'2"	550 18'0"	575 18'10"	600 19'8"
Pole 1003 with standard endcaps	68.40	80.29	92.21	104.15	116.04	127.96	139.89	151.81	163.71	175.66	187.58	199.46	211.40	223.32	235.24	247.15	259.06	270.99	282.93	294.83
Pole 1003 inc. finials																				
Crystal Square (Green/Brown/Black)	152.87	164.80	176.70	188.64	200.54	212.47	224.38	236.30	248.20	260.16	272.08	283.96	295.89	307.81	319.73	331.66	343.56	355.48	367.42	379.31
Crystal Cylinder (Green/Brown/Black)	174.74	182.69	194.57	206.46	218.33	230.24	242.10	253.99	265.87	277.76	289.65	301.50	313.39	325.28	337.16	349.06	360.93	372.82	384.72	396.58
Shard Cylinder clear	133.05	144.93	156.85	168.79	180.69	192.61	204.54	216.46	228.35	240.30	252.23	264.11	276.05	287.97	299.88	311.79	323.71	335.64	347.58	359.48
Shard Cylinder etched	147.90	159.79	171.70	183.64	195.54	207.46	219.39	231.31	243.20	255.15	267.08	278.96	290.90	302.82	314.74	326.64	338.56	350.49	362.43	374.33
Groove Ball	138.16	150.05	161.97	173.91	185.81	197.72	209.65	221.57	233.47	245.42	257.35	269.22	281.16	293.08	305.00	316.91	328.83	340.76	352.70	364.59
Groove Cylinder	99.85	111.74	123.66	135.60	147.49	159.41	171.34	183.26	195.16	207.11	219.03	230.91	242.85	254.77	266.69	278.60	290.51	302.44	314.38	326.28

1003 HAND DRAWN Ø 23mm – GUNMETAL/TAUPE

Size	125 4'1"	150 4'11"	175 5'8"	200 6'6"	225 7'4"	250 8'2"	275 9'0"	300 9'10"	325 10'8"	350 11'5"	375 12'4"	400 13'1"	425 13'11"	450 14'9"	475 15'7"	500 16'4"	525 17'2"	550 18'0"	575 18'10"	600 19'8"
Pole 1003 with standard endcaps	79.38	94.36	109.30	124.25	139.18	154.15	169.10	184.01	198.96	213.90	228.85	243.81	258.76	273.74	288.66	303.60	318.56	333.49	348.44	363.41
Pole 1003 inc. finials																				
Crystal Square (Green/Brown/Black)	163.87	178.86	193.79	208.76	223.68	238.64	253.60	268.49	283.45	298.40	313.34	328.31	343.25	358.22	373.16	388.10	403.05	418.00	432.93	447.90
Crystal Cylinder (Green/Brown/Black)	185.98	196.72	211.62	226.51	241.40	256.32	271.23	286.07	301.01	315.90	330.79	345.71	360.63	375.54	390.44	405.31	420.24	435.13	450.03	464.94
Shard Cylinder clear	144.03	159.01	173.95	188.90	203.83	218.80	233.75	248.65	263.61	278.54	293.50	308.45	323.41	338.38	353.31	368.24	383.21	398.13	413.09	428.05
Shard Cylinder etched	158.88	173.86	188.80	203.75	218.68	233.65	248.60	263.50	278.46	293.39	308.35	323.30	338.26	353.24	368.16	383.09	398.06	412.98	427.94	442.90
Groove Ball	149.15	164.12	179.07	194.01	208.95	223.91	238.87	253.77	268.73	283.66	298.62	313.57	328.53	343.50	358.43	373.36	388.33	403.25	418.20	433.17
Groove Cylinder	110.83	125.81	140.75	155.70	170.63	185.60	200.55	215.46	230.41	245.35	260.30	275.26	290.21	305.19	320.11	335.05	350.01	364.94	379.89	394.86

1003 HAND DRAWN Ø 23mm – CHROME EFFECT

Size	125 4'1"	150 4'11"	175 5'8"	200 6'6"	225 7'4"	250 8'2"	275 9'0"	300 9'10"	325 10'8"	350 11'5"	375 12'4"	400 13'1"
Pole 1003 with standard endcaps	108.32	128.24	148.14	168.07	187.98	207.89	227.79	247.67	267.63	287.50	307.44	327.33
Pole 1003 inc. finials												
Crystal Square (Green/Brown/Black)	192.80	212.75	232.62	252.57	272.47	292.40	312.29	332.16	352.12	372.00	391.93	411.82
Crystal Cylinder (Green/Brown/Black)	229.59	244.30	264.12	284.00	303.85	323.71	343.53	363.36	383.25	403.06	422.97	442.77
Shard Cylinder clear	172.96	192.89	212.78	232.72	252.63	272.53	292.44	312.31	332.28	352.14	372.09	391.98
Shard Cylinder etched	187.81	207.74	227.64	247.57	267.48	287.38	307.29	327.16	347.13	367.00	386.94	406.83

Bending (Max. trade discount 33¹/₃%) Angle bend: £25.50 each. Semi-circle or gradual curve: £40.00 each
All bent poles are supplied with adjustable brackets 0537.
For holdbacks see page 13.

All prices shown exclude VAT



Pole Systems **Metropole** by *Silent Gliss*

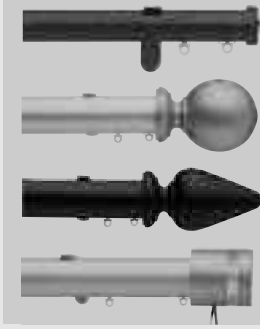

Metropole by *Silent Gliss*

A decorative curtain pole concept combining beautifully crafted design details with contemporary finishes on our pole systems 1003/6120/6130 /6140/6150 and 6160.



System 6120 cord operated, Ø 30mm can be bent to a minimum radius of 30cm

6120 CORD DRAWN Ø 30mm – SILVER/BLACK/WHITE/CREAM

Price Category A

Size	125 4'1"	150 4'11"	175 5'8"	200 6'6"	225 7'4"	250 8'2"	275 9'0"	300 9'10"	325 10'8"	350 11'5"	375 12'4"	400 13'1"	425 13'11"	450 14'9"	475 15'7"	500 16'4"	525 17'2"	550 18'0"	575 18'10"	600 19'8"
Pole with standard cording set	150.37	166.19	182.11	197.98	213.83	229.75	245.58	261.27	277.35	293.22	309.07	324.96	340.84	356.69	372.57	388.44	404.30	420.17	436.07	451.92
Pole 6120 inc. midials (2 no. per pole)																				
Palette Glass Discus (Lilac/Red/Amber/Purple/White)	298.46	314.28	330.19	346.06	361.91	377.83	393.65	409.34	425.41	441.29	457.14	473.03	488.89	504.75	520.62	536.52	552.38	568.24	584.14	599.99
Vega square	239.49	256.26	273.12	289.94	306.74	323.62	340.38	357.03	374.06	390.90	407.68	424.54	441.37	458.16	475.01	491.82	508.63	525.47	542.31	559.10
Vega circle	233.62	250.38	267.25	284.09	300.87	317.76	334.52	351.16	368.20	385.02	401.82	418.67	435.50	452.30	469.13	485.96	502.77	519.59	536.43	553.23
Pole 6120 inc. finials (2 no. per pole)																				
Overture Ball End	205.86	221.66	237.56	253.43	269.29	285.20	301.03	316.71	332.79	348.66	364.52	380.41	396.27	412.14	428.01	443.88	459.76	475.62	491.52	507.37
Spear	230.64	248.99	262.38	278.25	294.12	310.01	325.85	341.55	357.62	373.48	389.34	405.23	421.09	436.97	452.84	468.72	484.58	500.45	516.33	532.19
Strata - Clear/ribbed disc	223.97	239.80	255.69	271.58	287.42	303.35	319.18	334.85	350.93	366.81	382.67	398.55	414.42	430.28	446.14	462.03	477.90	493.76	509.66	525.51
Strata - Coloured disc	246.13	261.96	277.86	293.74	309.59	325.51	341.33	357.02	373.09	388.97	404.81	420.71	436.56	452.42	468.31	484.18	500.04	515.91	531.80	547.65
Groove Ball	259.07	274.89	290.82	306.69	322.54	338.45	354.28	369.97	386.05	401.92	417.77	433.66	449.54	465.39	481.27	497.14	513.00	528.87	544.77	560.62
Wave™ Standard Supplement																				
60mm Glider-cord	16.22	19.45	22.70	25.95	29.19	32.44	35.67	38.92	42.16	45.41	48.66	51.89	55.14	58.38	61.63	64.86	68.11	71.36	74.60	77.85
80mm Glider-cord	12.11	14.52	16.95	19.37	21.80	24.21	26.63	29.06	31.48	33.91	36.32	38.74	41.17	43.58	46.01	48.43	50.86	53.27	55.69	58.12
OR																				
Wave Supplement (with added optional extras)																				
60mm Glider-cord - single stack	31.04	34.28	37.53	40.78	44.01	47.27	50.49	53.74	56.98	60.23	63.48	66.72	69.97	73.20	76.45	79.69	82.94	86.19	89.42	92.67
80mm Glider-cord - single stack	26.92	29.35	31.77	34.19	36.62	39.04	41.45	43.88	46.30	48.73	51.14	53.55	55.99	58.40	60.83	63.24	65.68	68.09	70.51	72.94
60mm Glider-cord - pair stack	45.86	49.10	52.35	55.60	58.84	62.09	65.31	68.56	71.80	75.05	78.30	81.54	84.79	88.02	91.27	94.51	97.76	101.01	104.25	107.50
80mm Glider-cord - pair stack	41.75	44.17	46.59	49.01	51.44	53.86	56.27	58.71	61.12	63.55	65.96	68.37	70.81	73.22	75.65	78.07	80.50	82.91	85.33	87.76
Wave XL Supplement	64.53	77.44	90.35	103.25	116.16	129.07	141.98	154.88	167.79	180.70	193.60	206.51	219.42	232.32	245.23	258.14	272.34	285.31	298.28	311.25

6120 CORD DRAWN Ø 30mm – CLASSIC GOLD (max. length 4m)/GUNMETAL/STEEL GREY/BRONZE/ANTIQU BRONZE/SAND/TAUPE

Size	125 4'1"	150 4'11"	175 5'8"	200 6'6"	225 7'4"	250 8'2"	275 9'0"	300 9'10"	325 10'8"	350 11'5"	375 12'4"	400 13'1"	425 13'11"	450 14'9"	475 15'7"	500 16'4"	525 17'2"	550 18'0"	575 18'10"	600 19'8"
Pole with standard cording set	170.26	190.16	209.98	229.85	249.70	269.58	289.45	309.26	329.13	348.99	368.86	388.73	408.55	428.40	448.31	468.12	487.99	507.84	527.71	547.55
Pole 6120 inc. midials (2 no. per pole)																				
Palette Glass Discus (Lilac/Red/Amber/Purple/White)	318.34	338.23	358.06	377.92	397.78	417.66	437.52	457.34	477.20	497.07	516.93	536.79	556.65	576.49	596.37	616.19	636.06	655.93	675.76	695.64
Vega square	260.56	281.65	302.67	323.72	344.77	365.84	386.89	407.90	428.95	450.02	471.07	492.13	513.15	534.18	555.29	576.28	597.34	618.39	639.44	660.48
Vega circle	254.68	275.78	296.80	317.84	338.90	359.96	381.04	402.04	423.08	444.15	465.20	486.26	507.28	528.33	549.42	570.42	591.49	612.52	633.57	654.62
Pole 6120 inc. finials (2 no. per pole)																				
Overture Ball End	225.71	245.61	265.42	285.29	305.17	325.02	344.90	364.72	384.58	404.45	424.29	444.17	464.03	483.86	503.74	523.57	543.44	563.32	583.14	602.99
Spear	250.56	270.42	290.24	310.12	329.99	349.85	369.70	389.53	409.42	429.26	449.12	468.99	488.84	508.68	528.56	548.39	568.28	588.13	607.96	627.82
Strata - Clear/ribbed disc	243.86	263.75	283.58	303.45	323.29	343.16	363.05	382.87	402.72	422.57	442.45	462.32	482.15	502.00	521.89	541.72	561.59	581.44	601.28	621.15
Groove Ball (Not Classic)	278.96	298.86	318.68	338.55	358.40	378.28	398.15	417.97	437.83	457.69	477.56	497.43	517.25	537.10	557.01	576.83	596.69	616.54	636.41	656.25
Strata - Coloured disc	266.00	285.91	305.73	325.59	345.45	365.32	385.20	405.01	424.88	444.75	464.60	484.48	504.31	524.16	544.04	563.88	583.74	603.60	623.43	643.31
Wave™ Standard Supplement																				
60mm Glider-cord	16.22	19.45	22.70	25.95	29.19	32.44	35.67	38.92	42.16	45.41	48.66	51.89	55.14	58.38	61.63	64.86	68.11	71.36	74.60	77.85
80mm Glider-cord	12.11	14.52	16.95	19.37	21.80	24.21	26.63	29.06	31.48	33.91	36.32	38.74	41.17	43.58	46.01	48.43	50.86	53.27	55.69	58.12
OR																				
Wave Supplement (with added optional extras)																				
60mm Glider-cord - single stack	31.04	34.28	37.53	40.78	44.01	47.27	50.49	53.74	56.98	60.23	63.48	66.72	69.97	73.20	76.45	79.69	82.94	86.19	89.42	92.67
80mm Glider-cord - single stack	26.92	29.35	31.77	34.19	36.62	39.04	41.45	43.88	46.30	48.73	51.14	53.55	55.99	58.40	60.83	63.24	65.68	68.09	70.51	72.94
60mm Glider-cord - pair stack	45.86	49.10	52.35	55.60	58.84	62.09	65.31	68.56	71.80	75.05	78.30	81.54	84.79	88.02	91.27	94.51	97.76	101.01	104.25	107.50
80mm Glider-cord - pair stack	41.75	44.17	46.59	49.01	51.44	53.86	56.27	58.71	61.12	63.55	65.96	68.37	70.81	73.22	75.65	78.07	80.50	82.91	85.33	87.76
Wave XL Supplement	64.53	77.44	90.35	103.25	116.16	129.07	141.98	154.88	167.79	180.70	193.60	206.51	219.42	232.32	245.23	258.14	272.34	285.31	298.28	311.25

•Includes 1 x 10400 Cord retainer.

*Spear on system 6120 and 6130 is not available in classic gold or chrome finish.

Bending (Max. trade discount 33⅓%) Angle bend: £60.50 each. Semi-circle or gradual curve: £81.50 each

Optional accessories see page 13.

NOTE: Operating cord for 6120 Metropole system is supplied in black as standard. (White cord available at no extra cost.)

All bent poles are supplied with adjustable brackets 0537

All prices shown exclude VAT



Pole Systems *Metropole* by *Silent Gliss*



Metropole by *Silent Gliss*

A decorative curtain pole concept combining beautifully crafted design details with contemporary finishes on our pole systems 1003/6120/6130 /6140/6150 and 6160.



System 6120 cord operated, Ø 30mm can be bent to a minimum radius of 30cm

6120 CORD DRAWN Ø 30mm – CHROME EFFECT (max. length 4m)/OAK EFFECT (max. length 5m)

Size	125 4'1"	150 4'11"	175 5'8"	200 6'6"	225 7'4"	250 8'2"	275 9'0"	300 9'10"	325 10'8"	350 11'5"	375 12'4"	400 13'1"	425 13'11"	450 14'9"	475 15'7"	500 16'4"
Pole with standard cording set	202.78	230.28	257.85	285.38	312.87	340.39	367.93	395.47	423.00	450.53	478.05	505.56	533.08	560.62	588.15	615.68
Pole 6120 inc. midials (2 no. per pole)																
Palette Glass Discus (Lilac/Red/Amber/Purple/White)	350.85	378.35	405.91	433.45	460.95	488.49	516.01	543.55	571.05	598.59	626.12	653.64	681.18	708.70	736.23	763.74
Vega square	295.02	324.17	353.40	382.57	411.73	440.90	470.10	499.28	528.44	557.63	586.81	615.98	645.14	674.34	703.53	732.70
Vega circle	289.15	318.30	347.53	376.71	405.86	435.04	464.22	493.42	522.58	551.76	580.94	610.12	639.28	668.47	697.66	726.84
Pole 6120 inc. finials (2 no. per pole)																
Overture Ball End Chrome	258.21	285.72	313.29	340.84	368.33	395.87	423.38	450.91	478.43	505.97	533.50	560.63	588.53	616.32	643.60	671.12
Overture Ball End Wood	269.07	296.57	324.14	351.66	379.16	406.70	434.23	461.76	489.27	516.81	544.32	571.85	599.38	626.92	654.43	681.96
Strata - Clear/ribbed disc	305.14	332.63	360.18	387.72	415.23	442.77	470.30	497.81	525.34	552.85	580.39	607.92	635.46	662.96	690.50	718.03
Strata - Coloured disc	327.28	354.80	382.36	409.88	437.38	464.90	492.44	519.97	547.50	575.01	602.53	630.07	657.60	685.13	712.66	740.44
Wave™ Standard Supplement																
60mm Glider-cord	16.22	19.45	22.70	25.95	29.19	32.44	35.67	38.92	42.16	45.41	48.66	51.89	55.14	58.38	61.63	64.86
80mm Glider-cord	12.11	14.52	16.95	19.37	21.80	24.21	26.63	29.06	31.48	33.91	36.32	38.74	41.17	43.58	46.01	48.43
OR																
Wave Supplement (with added optional extras)																
60mm Glider-cord - single stack	31.04	34.28	37.53	40.78	44.01	47.27	50.49	53.74	56.98	60.23	63.48	66.72	69.97	73.20	76.45	79.69
80mm Glider-cord - single stack	26.92	29.35	31.77	34.19	36.62	39.04	41.45	43.88	46.30	48.73	51.14	53.55	55.99	58.40	60.83	63.24
60mm Glider-cord - pair stack	45.86	49.10	52.35	55.60	58.84	62.09	65.31	68.56	71.80	75.05	78.30	81.54	84.79	88.02	91.27	94.51
80mm Glider-cord - pair stack	41.75	44.17	46.59	49.01	51.44	53.86	56.27	58.71	61.12	63.55	65.96	68.37	70.81	73.22	75.65	78.07
Wave XL Supplement	64.53	77.44	90.35	103.25	116.16	129.07	141.98	154.88	167.79	180.70	193.60	206.51	219.42	232.32	245.23	258.14

•Includes 1 x 10400 Cord retainer.

*Spear on system 6120 and 6130 is not available in classic gold or chrome finish.

Bending (Max. trade discount 33¹/₃%) Angle bend: £60.50 each. Semi-circle or gradual curve: £81.50 each

NOTE: Operating cord for 6120 Metropole system is supplied in black as *standard*. (White cord available at no extra cost.)

All bent poles are supplied with adjustable brackets 0537

Holdbacks	Code	Intermediate Pulley	6165	£32.30 each
Holdback with Palette Glass Disc (all colours)	OHB40	£86.47 each		
Holdback with Vega Square	OHB80	£56.13 each		
Holdback with Vega Circle	OHB90	£53.37 each		

Bracket Supplements – Add the following supplement on to the system price if alternative brackets have been specified:

Pole Size cm	ft/ins	No. of Brackets	*3135/2 Extension Bracket 80mm		*3136/2 Extension Bracket 100mm		0674 Pillar Bracket			0989 Blok Bracket (6100M only)		
			Silver, White, Cream, Gold, Gunmetal, Black, Steel Grey, Bronze, Antique Bronze, Sand, Taupe	Chrome Effect, Oak	Silver, White, Cream, Gold, Gunmetal, Black, Steel Grey, Bronze, Antique Bronze, Sand, Taupe	Chrome Effect, Oak	White, Silver, Black, Cream	Chrome Effect, Gold, Gunmetal, Steel Grey, Bronze, Antique Bronze Sand, Taupe	Oak	Black, Silver Gunmetal, Steel Grey, Bronze, Antique Bronze	Chrome Effect	
125	4'1"	3	2.34	1.28	4.93	7.21	13.01	16.22	49.20	70.45	103.30	
150	4'11"	4	3.12	1.71	6.57	9.61	17.35	21.63	65.60	93.93	137.74	
175	5'8"	4	3.12	1.71	6.57	9.61	17.35	21.63	65.60	93.93	137.74	
200	6'6"	4	3.12	1.71	6.57	9.61	17.35	21.63	65.60	93.93	137.74	
225	7'4"	5	3.90	2.13	8.22	12.01	21.68	27.04	82.00	117.42	172.17	
250	8'2"	5	3.90	2.13	8.22	12.01	21.68	27.04	82.00	117.42	172.17	
275	9'0"	6	4.68	2.56	9.86	14.41	26.02	32.45	98.40	140.90	206.61	
300	9'10"	6	4.68	2.56	9.86	14.41	26.02	32.45	98.40	140.90	206.61	
325	10'8"	6	4.68	2.56	9.86	14.41	26.02	32.45	98.40	140.90	206.61	
350	11'5"	7	5.46	2.98	11.50	16.82	30.36	37.86	114.81	164.38	241.04	
375	12'4"	7	5.46	2.98	11.50	16.82	30.36	37.86	114.81	164.38	241.04	
400	13'1"	7	5.46	2.98	11.50	16.82	30.36	37.86	114.81	164.38	241.04	
425	13'11"	8	6.24	3.41	13.15	19.22	34.69	43.26	131.21	187.87	275.48	
450	14'9"	8	6.24	3.41	13.15	19.22	34.69	43.26	131.21	187.87	275.48	
475	15'7"	9	7.02	3.84	14.79	21.62	39.03	48.67	147.61	211.35	309.91	
500	16'4"	9	7.02	3.84	14.79	21.62	39.03	48.67	147.61	211.35	309.91	
525	17'2"	9	7.02	3.84	14.79	21.62	39.03	48.67	147.61	211.35	309.91	
550	18'0"	10	7.80	4.26	16.43	24.02	43.37	54.08	164.01	234.83	344.34	
575	18'10"	10	7.80	4.26	16.43	24.02	43.37	54.08	164.01	234.83	344.34	
600	19'8"	10	7.80	4.26	16.43	24.02	43.37	54.08	164.01	234.83	344.34	

*3135 and 3136 are supplied as standard at no additional charge for WAVE.

All prices shown exclude VAT



Pole Systems *Metropole* by *Silent Gliss*

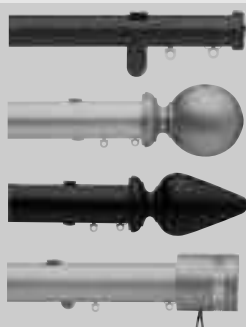

Metropole by *Silent Gliss*

A decorative curtain pole concept combining beautifully crafted design details with contemporary finishes on our pole systems 1003/6100/6120/6130/6140 6150 and 6160.

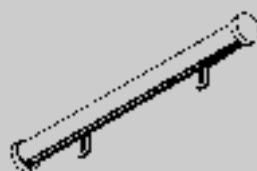

System 6130 hand operated, Ø 30mm can be bent to a minimum radius of 30cm

6130 HAND DRAWN Ø 30mm – CHROME EFFECT (max. length 3.95m)/OAK EFFECT (5m lengths only)

Price Category A

Size	125 4'1"	150 4'11"	175 5'8"	200 6'6"	225 7'4"	250 8'2"	275 9'0"	300 9'10"	325 10'8"	350 11'5"	375 12'4"	400 13'1"	425 13'11"	450 14'9"	475 15'7"	500 16'4"
Pole 6130 with standard endcaps	154.32	176.86	199.43	222.00	244.55	267.11	289.67	312.24	334.81	357.36	379.93	402.47	425.03	447.61	470.17	492.72
Pole 6130 inc. finials (2 no. per pole)																
Overture Ball End (Chrome Effect)	204.47	227.01	249.58	272.14	294.69	317.26	339.83	362.39	384.96	407.50	430.09	452.62	475.18	497.74	520.31	542.86
Overture Ball End (All wood effects)	211.78	234.31	256.88	279.46	302.02	324.57	347.13	369.69	392.27	414.82	437.41	459.93	482.49	505.04	527.63	550.18
Crystal Square	265.62	288.16	310.72	333.29	355.84	378.42	400.97	423.54	446.10	468.67	491.24	513.78	536.33	558.89	581.46	604.01
Crystal Cylinder	297.82	320.84	343.86	366.86	389.86	412.87	435.90	458.91	481.94	504.94	527.98	550.94	573.96	596.97	620.00	643.00
Vega - Cube	243.58	266.14	288.70	311.27	333.82	356.39	378.93	401.51	424.08	446.64	469.21	491.74	514.29	536.88	559.45	581.99
Vega - Cylinder	214.36	236.90	259.48	282.04	304.60	327.15	349.72	372.30	394.87	417.41	439.99	462.52	485.09	507.66	530.22	552.77
Strata - clear/ribbed disc	245.90	268.44	291.00	313.58	336.13	358.71	381.25	403.82	426.39	448.95	471.54	494.06	516.61	539.18	561.77	584.31
Strata - coloured disc	268.05	290.59	313.15	335.72	358.28	380.85	403.41	425.96	448.53	471.09	493.69	516.20	538.75	561.32	583.89	606.44
Shard Cylinder Clear	230.19	252.74	275.31	297.88	320.42	342.99	365.55	388.12	410.69	433.24	455.81	478.35	500.91	523.48	546.05	568.60
Shard Cylinder Etched	247.54	270.09	292.66	315.22	337.77	360.34	382.90	405.46	428.03	450.59	473.16	495.70	518.25	540.83	563.40	585.95
Design Endcap	183.52	206.07	228.63	251.20	273.75	296.32	318.87	341.44	364.01	386.57	409.14	431.67	454.23	476.81	499.38	521.92
Pole 6130 inc. midials (2 no. per pole)																
Pallet Glass Disc (Lilac/Red/Amber/Purple/White)	302.40	324.94	347.51	370.06	392.64	415.20	437.76	460.31	482.88	505.44	528.03	550.56	573.11	595.67	618.25	640.80
Vega square midial	231.08	253.62	276.18	298.76	321.31	343.88	366.43	389.00	411.57	434.13	456.70	479.23	501.79	524.37	546.94	569.48
Vega circle midial	235.56	259.23	282.91	306.61	330.29	353.98	377.68	401.37	425.05	448.74	472.44	496.10	519.80	543.49	567.21	590.88
Wave® Standard Supplement																
60mm Glider-cord	16.22	19.45	22.70	25.95	29.19	32.44	35.67	38.92	42.16	45.41	48.66	51.89	55.14	58.38	61.63	64.86
80mm Glider-cord	12.11	14.52	16.95	19.37	21.80	24.21	26.63	29.06	31.48	33.91	36.32	38.74	41.17	43.58	46.01	48.43
OR																
Wave Supplement (with added optional extras)																
60mm Glider-cord - single stack	48.20	51.44	54.69	57.94	61.18	64.43	67.65	70.90	74.14	77.39	80.64	83.88	87.13	90.36	93.61	96.85
80mm Glider-cord - single stack	44.09	46.51	48.93	51.35	53.78	56.20	58.61	61.05	63.46	65.89	68.30	70.71	73.15	75.56	77.99	80.41
60mm Glider-cord - pair stack	80.18	83.42	86.67	89.92	93.16	96.41	99.64	102.89	106.12	109.37	112.63	115.86	119.11	122.34	125.59	128.83
80mm Glider-cord - pair stack	76.07	78.49	80.91	83.34	85.76	88.18	90.59	93.03	95.44	97.87	100.29	102.70	105.13	107.54	109.98	112.39
Wave XL Supplement	64.53	77.44	90.35	103.25	116.16	129.07	141.98	154.88	167.79	180.70	193.60	206.51	219.42	232.32	245.23	258.14

Bending 6130 (Max. trade discount 33%/%) Angle bend: £60.00 each. Semi-circle or gradual curve: £81.00 each.
All bent poles are supplied with adjustable brackets 0537

Holdbacks	Code	Internal Connecting Bridge	6635	£32.30 each
Holdback with Palette Glass Disc (all colours)	OHB40	£86.47 each		
Holdback with Vega Square	OHB80	£56.13 each		
Holdback with Vega Circle	OHB90	£53.37 each		

Bracket Supplements – Add the following supplement on to the system price if alternative brackets have been specified:

Pole Size cm	No. of Brackets	*3135/2 Extension Bracket 80mm		*3136/2 Extension Bracket 100mm		0674 Pillar Bracket		0989 Blok Bracket (6100M only)		
		Silver, White, Cream, Gold, Gunmetal, Black, Steel Grey, Bronze, Antique Bronze, Sand, Taupe	Chrome Effect, Oak	Silver, White, Cream, Gold, Gunmetal, Black, Steel Grey, Bronze, Antique Bronze, Sand, Taupe	Chrome Effect, Oak	White, Silver, Black, Cream	Chrome Effect, Gold, Gunmetal, Steel Grey, Bronze, Antique Bronze Sand, Taupe	Oak	Black, Silver Gunmetal, Steel Grey, Bronze, Antique Bronze	Chrome Effect
125 4'1"	3	2.34	1.28	4.93	7.21	13.01	16.22	49.20	70.45	103.30
150 4'11"	4	3.12	1.71	6.57	9.61	17.35	21.63	65.60	93.93	137.74
175 5'8"	4	3.12	1.71	6.57	9.61	17.35	21.63	65.60	93.93	137.74
200 6'6"	4	3.12	1.71	6.57	9.61	17.35	21.63	65.60	93.93	137.74
225 7'4"	5	3.90	2.13	8.22	12.01	21.68	27.04	82.00	117.42	172.17
250 8'2"	5	3.90	2.13	8.22	12.01	21.68	27.04	82.00	117.42	172.17
275 9'0"	6	4.68	2.56	9.86	14.41	26.02	32.45	98.40	140.90	206.61
300 9'10"	6	4.68	2.56	9.86	14.41	26.02	32.45	98.40	140.90	206.61
325 10'8"	6	4.68	2.56	9.86	14.41	26.02	32.45	98.40	140.90	206.61
350 11'5"	7	5.46	2.98	11.50	16.82	30.36	37.86	114.81	164.38	241.04
375 12'4"	7	5.46	2.98	11.50	16.82	30.36	37.86	114.81	164.38	241.04
400 13'1"	7	5.46	2.98	11.50	16.82	30.36	37.86	114.81	164.38	241.04
425 13'11"	8	6.24	3.41	13.15	19.22	34.69	43.26	131.21	187.87	275.48
450 14'9"	8	6.24	3.41	13.15	19.22	34.69	43.26	131.21	187.87	275.48
475 15'7"	9	7.02	3.84	14.79	21.62	39.03	48.67	147.61	211.35	309.91
500 16'4"	9	7.02	3.84	14.79	21.62	39.03	48.67	147.61	211.35	309.91
525 17'2"	9	7.02	3.84	14.79	21.62	39.03	48.67	147.61	211.35	309.91
550 18'0"	10	7.80	4.26	16.43	24.02	43.37	54.08	164.01	234.83	344.34
575 18'10"	10	7.80	4.26	16.43	24.02	43.37	54.08	164.01	234.83	344.34
600 19'8"	10	7.80	4.26	16.43	24.02	43.37	54.08	164.01	234.83	344.34

*3135 and 3136 are supplied as standard at no additional charge for WAVE.

All prices shown exclude VAT



Shower Rail Systems

System 6100 System 6103

6101 rail in silver anodised finish.
6103 in chrome effect,
white and gold.

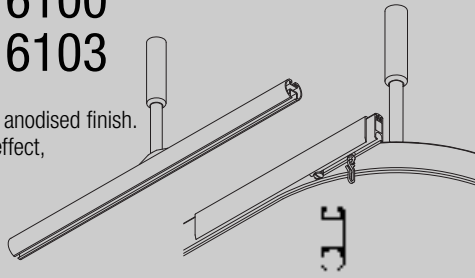

System 1085

Supplied in satin
silver finish as
standard. Track
profile available
in 6 metre
lengths only.



				Price Ctgy.
Ready, complete, pre-packed with all accessories, including hanger rod(s) where applicable.				A
System Prices				
		6100 Silver	6103 White	6103 Chrome effect/Gold
Model A	3' (91cm)	£38.81	£66.44	£89.44
	6' (183cm)	£61.10	£96.82	£150.93
	7' (213cm)	£68.97	£106.72	£170.94
	8' (244cm)	£78.40	£116.91	£191.67
Model B	2'6"x2'6" (76cmx76cm)	£81.22	£121.92	£180.40
	3'0"x3'0" (91cmx91cm)	£88.93	£131.90	£200.40
Model C-left Model D-right	5'6"x2'6" (168cmx76cm)	£103.55	£152.28	£241.87
Model E	3'0"x2'6" x3'0" (91cmx76cm x91cm)	£145.39	£199.17	£308.33
Special shapes for Shower Rails Send template and drawings for quotation. No special shapes on 1085				A

		Price Ctgy.
System Prices Ready, complete pre-packed with all accessories including hanger rod(s) where applicable.		A
Model A	Satin silver finish only	
3' (91cm)	£19.53	
6' (183cm)	£29.11	
7' (213cm)	£32.37	
8' (244cm)	£35.63	
Model B		
2'6" x 2'6" (76cm x 76cm)	£40.36	
3' x 3" (91cm x 91cm)	£44.25	
Model C (Left) Model D (Right)		
5'6" x 2'6" (168cm x 76cm)	£51.41	
Model E		
3' x 2'6" x 3' (91cm x 76cm x 91cm)	£73.20	

No special shower shapes available - use 6100/6103 systems.
Maximum size 1200mm x 1200mm

		Price Ctgy.
Accessories for 1085 when used as room divider, etc. Profile 1085		A
Silver available in 6m length or cut-to-size.		
3533/6146 Glider hook, 20.		
6146 Nylon hook, 12, 100.		
3610A Hanger rod assembly 61cm assembly complete.		
3616 Ceiling support complete with sleeve 3612, stud 3611, washer, grub screw.		
3611 Ceiling stud only.		
3699 Track insert only.		
3652 Wall support with 3017 endstop, grey.		
3533 Glider. Box 100. Outer, 25,000.		
3534 Glider in strip form. Outer, 1,000.		
3017 Endstop, each, 100.		
0715 Dustcap for 6650		

		Price Ctgy.
Colours Other colours - see Page 1.		E
Bending		
	Max. trade discount	33 1/3%
Angle bend £18.00		
Semi-circle or gradual curve, £24.50		

All prices shown
exclude VAT

Colours
Special order - see Page 2.

**Bending for special
shower rails**

Max. trade discount 33 1/3%

6101 Angle bend £18.00
Semi-circle or gradual curve £24.50
6103 Angle bend £45.00
Semi-circle or gradual curve £59.00



Cubicle, Room Divider Systems

Hospital Cubicle System available through approved Distributors only.

System 6100

Price Ctg.

A

Accessories

6101 Rail, silver, white. Available in following lengths: 4.5m, 4.75m, 5.0m, 5.25m, 5.5m, 6.0m, 6.75m, 7.5m available in silver only.
 6007 Endstop, silver, white, ea, 10.
 6055 Twist eye endstop, each, 10.
 6083 Glider, 100. Self-service sachets. Outer 25 x 25.
 6094 Roller glider with hook, 10, 100.
 6096 Strip glider. Outer, 1,000.
 6098 Roller glider with eye, 10, 100.
 6110 Dustcover for 6101, white, m.
 6124 Twist double ceiling fixing plate, silver, white, each.
 6137 Ceiling fixing plate (single), silver, white.
 6138 Ceiling fixing plate (double), silver, white.
 6143 Rotating glider, 20, 100.
 6146 Nylon hook only, 12, 100.
 6147 Nylon glider hook, 20. Box 500 (on strips). Outer 9,500.
 6160 Track insert for 6100, each.
 6190 Hanger rod assembly complete in silver and white, 61cm (2') or 91cm (3') or to order.
 6191 Hanger tube, silver and white, per metre.
 6188 Ceiling support complete with stud 6193, silver and white, 50mm, each.
 6192 Ceiling support complete with stud 6193, silver and white, 100mm.
 6194 Track insert.
 6197 Hanger joint sleeve.
 6283 Roller glider, 10, 100.
 6501 'V' Hanger assembly system, silver, white.
 6503 Wall brackets complete, silver, white.
 25mm long with 50mm projection.
 50mm long with 50mm projection.
 100mm long with 50mm projection.
 200mm long with 50mm projection.
 50mm long with 100mm projection.
 100mm long with 100mm projection.
 75mm long with 150mm projection.
 6512 Connecting bridge, silver, white.
 6514 T-junction, single, silver, white.
 6524 Diagonal fixing support, silver, white.
 6525 Double 'T' junction, each, silver, white.
 6609 Wall support, grey.
 6611 End cover with screw, grey, white, each.
 6625A Complete fixing sleeve, silver, white.
 6199 Internal connecting bridge.
 6187 Dummy ceiling support sleeve, silver, white.
 6175 Mini hanger, silver, white.
 0554 Loading device access.
 0553 Connecting bridge for loading device.
 0552 Transfer unit for loading device.

Note: For bent cubicle rail orders a crating charge of £34.93 is applicable.

Hospital Cubicle Safety Device System available through approved Distributors only – use in conjunction with System 6100

System 6650

Price Ctg.

A

Accessories

6675 Safety device.
 6655 Wall support.
 6677 V-hanger safety device.
 6663 Wall bracket connector plate.
 6666 Safety connecting bridge.
 6671 Washer insert for wall support.
 6672 Cover for washer insert.
 0785 Acrylic disc for wall support.

System 6103

Supplied in satin silver finish and white in 6 metre lengths. Gold and chrome in 4 metre lengths

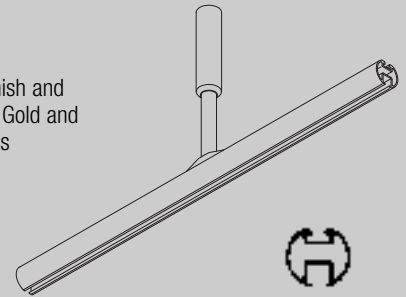

Price Ctg.

A

6103 Rail, silver, white, gold, chrome effect available in 6m lengths.
 0550A Wall supports, chrome and gold, pair.
 6007 Endstop, silver, white, each, 10.
 6065 Twist eye endstop, each, 10.
 6083 Glider, 100. Self-service sachets. Outer 25 x 25.
 6094 Roller glider with hook, 10, 100.
 6096 Strip glider. Outer 1,000.
 6098 Roller glider with eye, 10, 100.
 6110 Dustcover, metre, white.
 6124 Twist double ceiling fixing plate, silver, white, each.
 6143 Rotating glider, 20, 100.
 6146 Nylon hook only, 12, 100.
 6147 Nylon glider hook, 20. Box 500 (on strips). Outer, 9,500.
 6188 Ceiling support complete with stud 6193, 50mm, gold, white, silver and chrome.
 6190 Hanger rod assembly complete in silver, white, gold, chrome and other powder-coated colours. 61cm (2') 91cm (3') or to order.
 6191 Hanger tube, silver, white, gold and chrome, per metre.
 6192 Ceiling support complete with stud 6193, 100m each, silver, white, gold.
 6194 Track insert.
 6197 Hanger joint sleeve, silver, white.
 6283 Roller glider, 10, 100.
 6501 'V' Hanger assembly system, silver, white.
 6503 Wall brackets complete, silver, white
 25mm long with 50mm projection.
 50mm long with 50mm projection.
 100mm long with 50mm projection.
 200mm long with 50mm projection.
 50mm long with 100mm projection.
 100mm long with 100mm projection.
 75mm long with 150mm projection.
 6511 White plastic cover.
 6514M T-junction, single, silver, white.
 6525 Double 'T' junction, silver, white.
 6527 Wall support, metal, white.
 6620 Wall support complete, each, 10. Grey, each, 10. White.
 6625A Complete fixing sleeve, silver, white.
 6630 End cover, grey, white.
 6631 90° connector piece, grey, white.
 6635 Internal connecting bridge.
 6521 External connecting bridge, silver, white.
 6524 Diagonal fixing support, silver, white.
 6175 Mini hanger.

Price Ctg.

E

Colours

(all colours except white, chrome and gold special order – see page 1).

Bends

Angle bend £43.00
 Semi-circle or gradual curve, £59.50

Price Ctg.

E

331/3%

All prices shown exclude VAT



Electrically Operated Curtain Tracks

System 5090

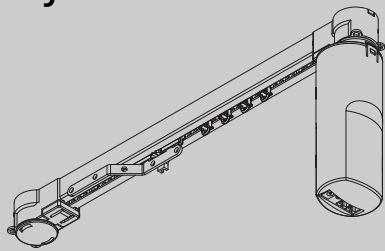

System 5090 Basic
System 5090IR with remote control
System 5090TL with timer light unit
System 5090TC total control option

	Price Ctg.
System Prices Ready complete and assembled in white only.	
System 5090	A
Basic	
Length	£
cm	
100	351.05
150	373.51
200	396.00
250	418.47
300	440.95
350	463.40
400	485.89
450	508.37
500	530.85
System 5090IR with Remote Control	A
Length	£
cm	
100	435.29
150	457.76
200	480.24
250	502.73
300	525.19
350	547.66
400	570.13
450	592.61
500	615.09
System 5090TL with Timer Light Unit	A
Length	£
cm	
100	409.44
150	431.91
200	454.39
250	476.86
300	499.33
350	521.58
400	544.28
450	566.77
500	589.24
System 5090TC Total Control option	A
Length	£
cm	
100	552.07
150	574.54
200	597.02
250	619.51
300	641.98
350	664.46
400	686.92
450	709.41
500	731.89

All prices shown exclude VAT

	Price Ctg.
System 5090 (all models) With Wave® Standard. Add the following supplement to the standard system price.	A
Glider Cord	
	60mm 80mm
100	12.42 9.14
150	18.63 13.71
200	24.84 18.27
250	31.05 22.85
300	37.27 27.41
350	43.47 31.97
400	49.69 36.55
450	55.90 41.12
500	62.11 45.68
System 5090 With Enhanced Wave®	
	60mm 80mm 80mm
Stack	single pair single pair
100	24.67 41.51 21.38 38.22
150	30.87 47.71 25.95 42.80
200	37.09 53.93 30.52 47.36
250	43.29 60.14 35.09 51.93
300	49.51 66.35 39.65 56.50
350	55.72 72.56 44.22 61.06
400	61.93 78.78 48.79 65.63
450	68.15 84.99 53.36 70.21
500	74.35 91.20 57.93 74.77
Standard Accessories	A
10002	Pulley housing
10003	Pulley housing lid
10004	Locking plate
10005	Blanking plate
10007	Floating carrier
10008	Overlap arm left
10009	Overlap arm right
10060	Manual override left
10061	Manual override right
10062	Manual override left overlap arm
10063	Manual override right overlap arm
10010	End stop
2191	Profile
3826	Top fix bracket
3836	Bracket (62mm)
5005	Master carrier
5127	Clip
5130	Driving belt
5152	Driving Wheel
6143	Glider 6144 in strip form
Sets	
5091	Motor Set, containing motor, power supply unit and switch
Optional Accessories	
3133	Bracket cover (60mm)
3135	Extension bracket (80mm)
3136	Extension bracket (100mm)
6064	Screw twist endstop
6349	Wave® Heading Tape
6345	Wave® glider cord (60mm)
6346	Wave® glider cord (80mm)
6363	Top hemming tape
Sets	
5093	Infrared Set IR, containing IR Transmitter/IR Sensor
5092	Timer Set TL, containing timer and dawn dusk sensor
Colours	E
Colours other than white special order – see page 1. Motor only in white.	
Bends	
Max 2 no. 90° bends or one curve: £118.00.	
Note:	Autoglide is made-to-measure and cannot be cut down.

System 5200

Profile only 2191

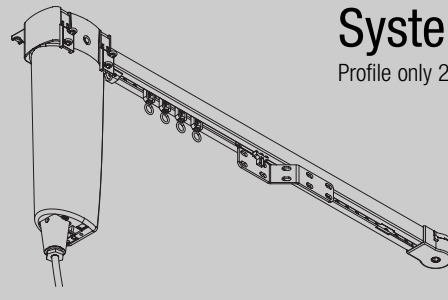

Supplied in silver, white, bronze and black. Endpieces sprayed to match, motor grey.

	Price Ctg.		
System Prices 2200 (Motor 9040) Ready complete and assembled.	C		
Length	Length		
M	M		
£	£		
1.5	947.32 6.0 1134.40		
2.0	968.13 6.5 1161.88		
2.5	988.89 7.0 1182.67		
3.0	1009.68 7.5 1203.43		
3.5	1030.48 8.0 1224.22		
4.0	1051.25 8.5 1245.02		
4.5	1072.05 9.0 1265.79		
5.0	1092.81 9.5 1286.57		
5.5	1113.61 10.0 1307.36		
5200 with integrated Radio Control Receiver (Motor 9041) For use with Silent Gliss Radio Control System 0450, or motor (9041EL) for use with Silent Gliss Control System 9940.			
Length	Length		
M	M		
£	£		
1.5	1079.12 6.0 1266.17		
2.0	1099.90 6.5 1293.66		
2.5	1120.68 7.0 1314.44		
3.0	1141.48 7.5 1335.23		
3.5	1162.26 8.0 1356.00		
4.0	1183.04 8.5 1376.79		
4.5	1203.82 9.0 1397.58		
5.0	1224.61 9.5 1418.36		
5.5	1245.39 10.0 1439.14		
System 5200 is available with Enhanced Wave™, Wave® Standard and Wave XL curtain heading systems.			
Enhanced Wave® and Wave® Standard - No additional price			
Wave XL - Supplement £28.66 per metre			
Roller Wave® - Supplement £31.82 per metre			
Standard Accessories	C		
2191	Profile		
3825	Clamp (35mm)		
5002	Right hand overlap arm (pair stack)		
5003	Overlap arm (single stack)		
5004	Overlap arm left (pair stack)		
5112	Mask for pair stack		
5120	Master carrier		
5130	Drive belt		
6086	Spring stop		
6098	Roller glider with eye		
9040	Motor		
9121	Driving set		
10040	Power supply		
10048	Power lead		
Optional Accessories	C		
0565	Non-latching switch		
0615	Latching switch inc. pattress box		
0913	Wall mounted switch single-channel BS Brushed Stainless/MP Mirror Polish/BR Brass		
0914	Wall mounted switch 8-channel BS Brushed Stainless/MP Mirror Polish/BR Brass		
0915	Hand held transmitter single-channel		
0939	Multi-channel transmitter		
2216	Cord		
3826W	Nylon top fix bracket		
3836	Nylon wall bracket		
5112	Mask for pair stack		
5114	Ceiling cover plate		
5115	Connecting bridge		
5117	Recess profile, metre		
5118	Wedge		
6007	Endstop		
9041	Motor 24V DC, radio receiver		
10060	Manual override left		
10061	Manual override right		
10062	Manual override left overlap arm		
10063	Manual override right overlap arm		
3582	Curtain hooks		
6345	Glider-cord 60mm pitch		
6346	Glider-cord 80mm pitch		
6349	Wave® curtain tape		
6363	Iron-on hemming tape		
6364	Extension		
6365	Hanger		
6367	Master carrier		
6368	Carrier		
6391	Hanger		
10074	Lead weight tape		
10076	Fabric weight		
Fixed Extension Brackets	A		
Each with 1 or 2 pre-drilled and tapped holes.			
Silver	White	Brown	
3134	2"/50mm (1)	3135	3"/75mm (2)
3136	4"/100mm (2)	3137	5"/125mm (2)
Each with 3 pre-drilled and tapped holes.			
3138	6"/150mm	3139	7"/175mm
Adjustable extension brackets			
Silver	White	Brown	
3275	7.7cm -	10.7cm	
3276	10cm -	13cm	
3277	13cm -	16cm	
6094	Roller glider with hook, 10, 100		
6283	Roller glider, 10, 100		
3133	Bracket cover		
3133L	Bracket cover (3138/9)		
3832	Twist clamp		
3615	Clamp		
Colours			C
Add to price	per metre	+ per length	
Bz/Bl	£13.47	£13.86	
Motor in grey, endpiece sprayed to match. Other colours special order, see page 1.			E
Bends	Max. trade discount		25%
For each bend add the following to above system price:			
Radius/cm	Profile 2191		
25-99	£115.36		
Over 99	£218.36		
Multiple System Operation			C
A wide range of multiple operation methods are available, including low voltage control, radio/remote control and mixed systems. Please consult the Silent Gliss catalogue			



Electrically Operated Curtain Tracks

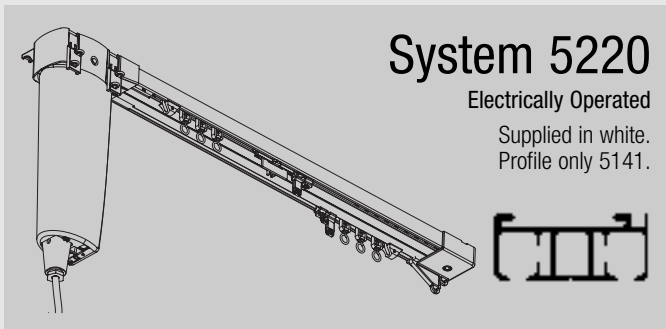

System 5220

Electrically Operated

Supplied in white.
Profile only 5141.

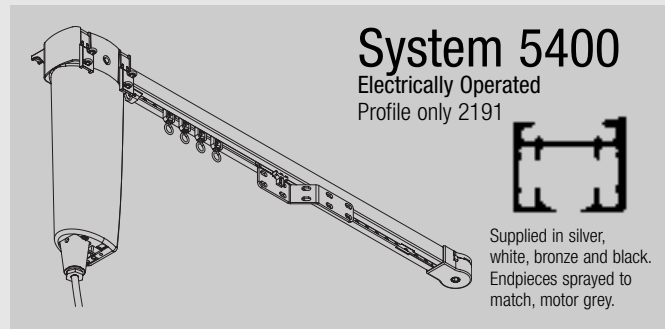

System 5400

Electrically Operated
Profile only 2191



Supplied in silver,
white, bronze and black.
Endpieces sprayed to
match, motor grey.

	Price Ctg.
--	------------

System Prices

5220 (Motor 9040)

Ready complete and assembled.

Length

M	£
1.5	1055.96
2.0	1086.80
2.5	1118.02
3.0	1149.22
3.5	1180.46
4.0	1211.68
4.5	1242.90
5.0	1274.09
5.5	1305.31
6.0	1336.53
6.5	1400.29
7.0	1431.46
7.5	1462.68
8.0	1493.90
8.5	1525.12
9.0	1556.33
9.5	1587.55
10.0	1618.78

5220 with integrated Radio Control Receiver (Motor 9041)

For use with Silent Gliss Radio Control System 0450 or with (motor 9041EL). For use with Silent Gliss Control System 9940.

Length

M	£
1.5	1222.99
2.0	1255.15
2.5	1287.32
3.0	1319.43
3.5	1351.60
4.0	1383.75
4.5	1415.92
5.0	1448.07
5.5	1480.21
6.0	1512.37
6.5	1577.66
7.0	1610.14
7.5	1642.30
8.0	1674.47
8.5	1706.62
9.0	1738.75
9.5	1770.91
10.0	1803.07

	Price Ctg.
--	------------

Standard Accessories

- 3033 Clamp
- 5130 Drive Belt
- 5141 Profile
- 6086 Spring stop
- 6098 Roller glider with eye
- 9040 Motor 24V DC
- 9122 Guide Set
- 10040 Power supply
- 10048 Power lead

Optional Accessories

- 0565 Non-latching switch
- 3239D Bracket
- 5003 Overlap arm (single stack)
- 5331 Steel wire
- 5651 Programming cable
- 6007 Endstop
- 6094 Roller guide with hook
- 6283 Roller glider
- 9123 Driving set for 5220 manual override

Colours

Other colours to special order, see page 1.

Bends Max. trade discount 25%

For each bend add the following to above system price:
Single angle bend £295.00
Semi-circle or gradual curve £552.00

Multiple

System Operation

A wide range of multiple operation methods are available, including low voltage control, radio/remote control and mixed systems. Please consult the Silent Gliss catalogue.

	Price Ctg.
--	------------

System Prices

5400 (Motor 9020)

Ready complete and assembled.

Length		Length	
M	£	M	£
1.5	1052.58	6.0	1260.44
2.0	1075.70	6.5	1290.98
2.5	1098.77	7.0	1314.07
3.0	1121.86	7.5	1337.15
3.5	1144.98	8.0	1360.24
4.0	1168.06	8.5	1383.35
4.5	1191.15	9.0	1406.43
5.0	1214.25	9.5	1429.53
5.5	1237.34	10.0	1452.61

5400 with integrated Radio Control Receiver (Motor 9021)

For use with Silent Gliss Radio Control System 0450 or with (motor 9021EL). For use with Silent Gliss Control System 9940.

Length		Length	
M	£	M	£
1.5	1199.03	6.0	1406.86
2.0	1222.12	6.5	1437.41
2.5	1245.19	7.0	1460.49
3.0	1268.29	7.5	1483.59
3.5	1291.40	8.0	1506.67
4.0	1314.50	8.5	1529.78
4.5	1337.58	9.0	1552.86
5.0	1360.67	9.5	1575.95
5.5	1383.77	10.0	1599.04

System 5400 is available with Enhanced Wave[®], Wave[™] Standard and Wave XL curtain heading systems.

Enhanced Wave[®] and Wave[®] Standard - No additional price
Wave XL - Supplement £29.07 per metre
Roller Wave[®] - Supplement £31.82 per metre

Standard Accessories

- 0562 Lead with in-line connector
- 2191 Profile
- 3825 Clamp (35mm)
- 5002 Right hand overlap arm (pair stack)
- 5003 Overlap arm (single stack)
- 5004 Overlap arm left (pair stack)
- 5112 Mask for pair stack
- 5120 Master carrier
- 5130 Drive belt
- 6086 Spring stop
- 6098 Roller glider with eye
- 9121 Driving set

	Price Ctg.
--	------------

Optional Accessories

- 0565 Non-latching switch
- 0615 Latching switch inc. pattress box
- 2216 Cord
- 3826 Nylon top fix bracket
- 3836 Nylon wall bracket
- 5112 Mask for pair stack
- 5114 Ceiling cover plate
- 5115 Connecting bridge
- 5117 Recess profile, metre
- 5118 Wedge
- 6007 Endstop
- 10376 Manual override left
- 10061 Manual override right
- 10375 Manual override straight

- 3582 Curtain hooks
- 6345 Glider-cord 60mm pitch
- 6346 Glider-cord 80mm pitch
- 6349 Wave[®] curtain tape
- 6363 Iron-on hemming tape
- 6364 Extension
- 6365 Hanger
- 6367 Master carrier
- 6368 Carrier
- 6391 Hanger
- 10074 Lead weight tape
- 10076 Fabric weight

- Fixed Extension Brackets**
- Each with 1 or 2 pre-drilled and tapped holes.
- Silver White Brown**
- 3134 2"/50mm (1) 3135 3"/75mm (2)
- 3136 4"/100mm (2) 3137 5"/125mm (2)
- Each with 3 pre-drilled and tapped holes.

- 3138 6"/150mm 3139 7"/175mm

Adjustable extension brackets

- Silver White Brown**
- 3275 7.7cm - 10.7cm
- 3276 10cm - 13cm
- 3277 13cm - 16cm

- 6094 Roller glider with hook, 10, 100
- 6283 Roller glider, 10, 100
- 3133 Bracket cover
- 3133L Bracket cover (3138/9)
- 3832 Twist clamp
- 3615 Clamp

Colours

Add to price	per metre	+ per length
Bz/Bl	£13.15	£13.87

Motor in grey, endpiece sprayed to match. Other colours special order, see page 1.

Bends Max. trade discount 25%

For each bend add the following to above system price:
Radius/cm Profile 2191
25-99 £115.36
Over 99 £218.36

Multiple

System Operation

A wide range of multiple operation methods are available, including low voltage control, radio/remote control and mixed systems. Please consult the Silent Gliss catalogue.



Electrically Operated Curtain Tracks

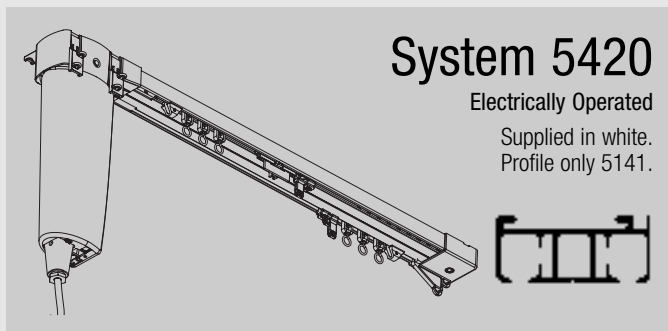

System 5420

Electrically Operated

Supplied in white.
Profile only 5141.



System 5300

Electrically Operated

Profile only 5301
Supplied in silver and white.



	Price Ctgy.
--	----------------

System Prices

5420 (Motor 9020)

Ready complete and assembled.

Length

M	£
1.5	1173.29
2.0	1207.57
2.5	1242.24
3.0	1276.92
3.5	1311.62
4.0	1346.30
4.5	1381.00
5.0	1415.65
5.5	1450.34
6.0	1485.04
6.5	1555.87
7.0	1590.52
7.5	1625.21
8.0	1659.90
8.5	1694.58
9.0	1729.26
9.5	1763.95
10.0	1798.64

5420 with integrated Radio Control Receiver (Motor 9021)

For use with Silent Gliss Radio

Control System 0450 or (motor 9021EL) for
use with Silent Gliss Control System 9940

Length M	£
1.5	1358.89
2.0	1394.62
2.5	1430.36
3.0	1466.04
3.5	1501.77
4.0	1537.50
4.5	1573.25
5.0	1608.95
5.5	1644.68
6.0	1680.40
6.5	1753.35
7.0	1789.05
7.5	1824.77
8.0	1860.51
8.5	1896.24
9.0	1931.94
9.5	1967.68
10.0	2003.40

	Price Ctgy.
--	----------------

Standard Accessories

- 0562 Lead with in-line connector
- 2613 Connector (38mm)
- 3033 Clamp
- 5130 Drive belt
- 5141 Profile
- 6086 Spring stop
- 6098 Roller glider with eye
- 9122 Guide Set

Optional Accessories

- 0565 Non-latching switch
- 0615 Latching switch inc. pattress box
- 2962 Connecting bridge
- 3239D Bracket
- 5651 Programming cable

Colours

Other colours to special order,
see page 1.

Bends Max. trade discount

For each bend add the
following to above system price:
Single angle bend £295.00
Semi-circle or gradual curve £552.00

Multiple

System Operation

A wide range of multiple operation
methods are available, including
low voltage control, radio/remote
control and mixed systems.
Please consult the Silent Gliss
catalogue.

	Price Ctgy.
--	----------------

System Prices

Ready complete and
assembled

Length M	£
2	2714.68
3	2815.06
4	2915.45
5	3015.85
6	3116.22
7	3216.61
8	3317.02
9	3417.42
10	3517.82
11	3618.23
12	3718.61
13	3818.98
14	3919.41
15	4019.80
16	4120.21
17	4220.60
18	4321.00
19	4421.41
20	4521.80
21	4622.22
22	4722.58
23	4822.99
24	4923.39
25	5023.81

Track lengths between those
specified will be charged at the
rate for the nearest metre above.
Satin silver or white as standard.

Standard Accessories

- 0562 Lead with in-line connector
- 5301 Profile, 6 metre length
silver, white.
- 5304 Endpiece set, white, grey.
- 5310 Return set, white, grey.
- 5312 Endstop.
- 5317 Master carrier set.
- 5318 Motor support.
- 5320 Clamp.
- 5302 Cylinder belt, per metre.
- 5360 Motor.

- 6098 Roller glider, at 10 per
metre, 10, 100.
- 6086 Spring stop, each, 10, 100.

	Price Ctgy.
--	----------------

Optional Accessories

- 0565 Non-latching switch.
- 6094 Roller glider with hook,
10, 100.

- 0578 Recess pattress, metal.
- 5319 Connecting bridge.
- 5670 Overlap arm (single stack).
- 3239 Fixed extension bracket.

Colours

Other colours special order –
see page 1.

Bends

For each bend add the
following to above system price:
Single angle bend £295.00
Semi-circle or gradual curve
£552.00

Multiple

System Operation

A wide range of multiple
operation methods are
available, including low
voltage control, radio/remote
control and mixed systems.
Please consult the Silent Gliss
catalogue.

All prices shown
exclude VAT

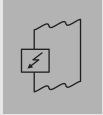

Electrically Operated Curtain Tracks

System 5800

Electrically Operated



5810

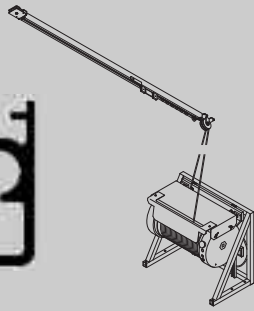

System Prices			Price Ctgy.
Ready complete and assembled (as far as possible depending on transport requirements).			C
Length M	Price Single Track £	Price 2 Parallel Tracks £	
12	8005.72	8897.35	
13	8148.62	9094.88	
14	8291.48	9292.41	
15	8434.39	9489.96	
16	8577.25	9687.50	
17	8720.13	9885.03	
18	8863.04	10082.58	
19	9005.86	10280.12	
20	9009.21	10477.68	
21	9291.64	10675.20	
22	9434.54	10872.72	
23	9577.41	11070.28	
24	9720.27	11267.77	
25	9863.19	11465.35	
26	10006.04	11662.88	
27	10148.95	11860.40	

System 5800 can cover windows up to 60m if pair stacked. On lengths of this size Silent Gliss advice should be sought but as a guide price for each metre above 27m the following should be added:

Single width £128.20

Two tracks in parallel £177.36

Track lengths between those specified will be charged at the rate for the nearest metre above. Price includes 6209 Top fix clamps, 5821/22 Wall mounting for motor, 5811 Overlap, 5809 Roller gliders at 5 per metre and where length exceeds 6 metres 6203 Connecting bridge. 5741 Plug, 5742 Surface socket and 0615 plastic switch with recess box. Earth is required.

Standard Accessories

- 5806 Pilot Runner.
- 5809 Roller glider, 10.
- 5810 Silver profile only.
- 5824 Endstop.
- 5811 Overlap.
- 5814 Cable, metre.
- 5815 Cord guide return.
- 5816 Cord guide.
- 5834 Cable connector.
- 6203 Connecting bridge.
- 6209 Clamp, each, 10.

Optional Accessories			Price Ctgy.
0578 Recess pattress, metal.			C
0615 Latching switch			
6228 Double fixing plate.			
5829 2 Hole fixing plate.			
5813 Floor mounting frame.			
Colours			E
Special quotation.			
Bending	Max trade discount		25%
Radius cm	Each £		
32-99	243.50		
99-349	360.50		
over 350	471.00		
Remote/Multiple System Operation			C
Must not be wired in parallel. For information consult Silent Gliss			

All prices shown
exclude VAT



Switches, Remote Control & Multiple Operation of Motorised Systems

System 0450

Radio controlled systems

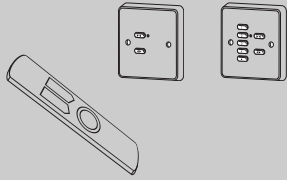

System 9940

Radio controlled systems

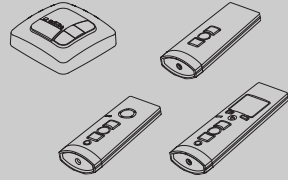

Other Accessories

All costs for systems indicated in this section are exclusive of curtain/blind systems and need to be added for total cost. On-site wiring costs are also excluded although advisory service is available. To assist choosing the correct equipment please see application chart in the back of the price list.

	Price Ctg.
System 0450	C
Radio control system, up to 255 room and blind addresses, individually or simultaneously. Use with mains electric systems (motor types A & B). Low voltage option (motor type C) available on request.	
0918 Control Module (motor type A)	£246.81
0919 Control Module (motor type B)	£246.81
0907 Control Module (low voltage motor type C)	£266.45
0913BS Single-channel wall switch – brushed silver	£193.29
0913MP Single-channel wall switch – mirror polished	£193.29
0913BR Single-channel wall switch – brass	£221.63
0914BS Eight-channel wall switch – brushed silver	£193.29
0914MP Eight-channel wall switch – mirror polished	£193.29
0914BR Eight-channel wall switch – brass	£221.63
0915 Single-channel hand-held remote	£183.90
0939 Multi-channel transmitter	£239.11

	Price Ctg.
Optional Accessories	C
0917 White patress box	£17.51

All prices shown exclude VAT

	Price Ctg.
System 9940	C
9946 Single-channel wall switch	£132.71
9948 Single-channel programmable wall switch with timer	£331.79
9952 Hard wired timer switch	£201.16
10300 Single-channel hand-held remote	£185.36
10302 5+1 channel hand-held remote	£185.36
10303 10+2+1 channel hand-held remote	£225.89
9068 Single-channel receiver	£328.82
9944 Single-channel receiver, non latching	£252.13
9945 Single-channel receiver, latching	£227.97
9947 Control Unit DC 24V	£148.98
10297 Solar sensor	£311.70
10298 Sensor	£281.67
Uplift for integrated receiver in dim-out, Roller and Roman Blinds	£148.95

Engraving of above remotes is available at £26.78 per remote.

All prices shown exclude VAT

	Price Ctg.
Fixed switches for mains control	C
Switches are available single or in banks as below. Add switches price to price of system. Switches are designed for recess fixing.	
Non-latching	
1 Gang Switches	
0565/W White plastic	£85.64
2 Gang Switches	
0566/W White plastic	£148.26
3 Gang Switches	
0567/W White plastic	£230.88
4 Gang Switches	
0568/W White plastic	£292.68
6 Gang Switches	
0569/W White plastic	£443.10
Latching	
1 Gang Switches	
0615/W White plastic	£46.25
2 Gang Switches	
0616 White plastic	£62.35
3 Gang Switches	
0617 White plastic	£101.32
4 Gang Switches	
0618 White plastic	£121.83
6 Gang Switches	
0619 White plastic	£168.85

	Price Ctg.
Extras	C
0934 Antenna	£133.90
5736 Relay	£124.67
0521 Motor Lead	£82.09
0570 Volt free switching module	£161.75

	Price Ctg.
Tools	E
0539 Crimping Tool	

All prices shown exclude VAT



Roman Blind Systems

System 2020

Chain operated headrail system for Austrian/Roman and Festoon Blinds.

For light to medium weight applications.

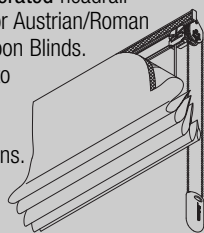

System 2120

Chain operated headrail system for Austrian/Roman and Festoon Blinds.

For medium to heavy weight applications.

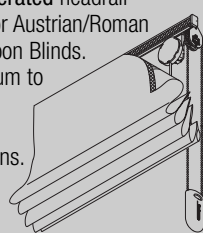

System 2320

Chain operated headrail system for Austrian/Roman and Festoon Blinds

with new wind up mechanism.

For light to medium weight applications.

System 2330

Chain operated (4:1 geared) roman blind system for residential and contract applications.

Suitable for light to medium weight applications.

		Price Ctgy.
2020 System supplied ready assembled		A
Total max. curtain weight 3kg incl. any weighting.		
Maximum width: 2.5m		
Maximum drop: 3.0m		
System width		
cms	£	
100	103.70	
125	120.24	
150	136.83	
175	153.35	
200	169.85	
225	186.40	
250	202.95	
Above prices are based on standard accessories detailed below.		

		Price Ctgy.
Standard Accessories		A
2032 Tape spool cassette (with 3m lift tape) each 10, 100, 250.		
2049 Gear drive, each, 10, 100.		
2059 Safety clip, 10.		
2111 Hexagonal bar, 6m length, outer of 50 lengths.		
2116 Velcro headrail, 5m length.		
2131 End cover, each, 10.		
3073 Bottom tape ring, each, 10.		
3630 Universal bracket, each, 10, 100.		
4845 Metal bead chain, 125m reel.		
3056 Tape centralizer, 10.		

2865 Twin chain connector, each.		C

10400 Cord retainer.		E

		Price Ctgy.
Optional Accessories		A
0549 Touch and close pencil pleat tape for Austrian Blinds.		
2006 Bottom weight bar, 4m.		
2048 Bead chain, white, 100m reel.		
2093 Ring, 10, 100.		
2164/2164T Ring tape, 50m.		
2196 Lead weight tape, 50m.		
2539 Velcro pile section, 25m, 100m.		
2826 Chain connector, each, 10.		
3055 Hook, each, 10.		
3133 Bracket cover.		
3133L Bracket cover long.		
3134-9 Fixed extension brackets.		
3340 cord weight white, each 10, 100.		
3340 cord weight grey, chrome, each 10, 100.		
3603 Top fix brackets, each, 10, 100.		
3655 Long universal bracket.		
3660 Extra long universal bracket.		
4845BR Metal bead chain, brass.		

		Price Ctgy.
Tools		E
0679 Connector tongs.		

All prices shown exclude VAT

		Price Ctgy.
2120 System supplied ready assembled		A
Total max. curtain weight 8kg incl. any weighting.		
Maximum width: 4.0m		
Maximum drop: 6.0m		
System width		
cms	£	
100	143.22	
125	164.88	
150	192.63	
175	221.02	
200	242.67	
225	270.59	
250	298.51	
275	320.18	
300	348.11	
325	376.06	
350	407.97	
375	431.98	
400	459.92	
Above prices are based on standard accessories detailed below.		

		Price Ctgy.
Standard Accessories		A
2049 Gear drive, each, 10, 100.		
2081 Take-up reel, each, 10.		
2059 Safety clip, 10.		
2111 Hexagonal bar, 6m length, outer of 50 lengths.		
2163 Flat drawing tape, per m, 100m		
2211 Velcro headrail, 6m, length.		
2179 End cover, each, 10.		
3073 Bottom tape ring, each, 10.		
3630 Universal bracket, each, 10, 100.		
4845 Metal bead chain, 125m reel.		

2865 Twin chain connector, each.		C

10400 Cord retainer.		E

		Price Ctgy.
Optional Accessories		A
0549 Touch and close pencil pleat tape for Austrian Blinds.		
2006 Bottom weight bar, 4m.		
2048 Bead chain, white, 100m reel.		
2072A Universal joint, each.		
2093 Ring, 10, 100.		
2164/2164T Ring tape, 50m.		
2196 Lead weight tape, 50m.		
2539 Velcro pile section, 25m, 100m.		
3055 Hook, each, 10.		
3133 Bracket cover.		
3133L Bracket cover long.		
3134-9 Fixed extension brackets.		
3340 cord weight white, each 10, 100.		
3340 cord weight grey, chrome, each 10, 100.		
3603 Top fix brackets, each, 10, 100.		
3655 Long universal bracket.		
3660 Extra long universal bracket.		
4845BR Metal bead chain, brass.		

		Price Ctgy.
Tools		E
0679 Connector tongs.		

		Price Ctgy.
2320 System supplied ready assembled		A
Max curtain weight 2.5kg inc any weighting.		
Maximum width: 3.0m		
Maximum drop: 3.0m		
System width		
cms	£	
100	107.54	
125	123.49	
150	139.41	
175	155.35	
200	171.29	
225	187.23	
250	203.20	
275	219.13	
300	235.07	
Above prices are based on standard accessories detailed below.		

		Price Ctgy.
Standard Accessories		A
2221 Velcro Tape per m, 100m.		
2322 Pin.		
2327 Adapter.		
2341 Wheel for steel bead chain.		
2216 Cord (diameter 0.85mm) 10m, 50m, 100m.		
2321 Profile.		
2323 Shell.		
2328 Adapter.		
2334 Sleeve.		
2335 Drive case 1:1.		
2337 End cover.		
2343 Universal bracket.		
4845 Steel bead chain (diameter 4.6mm) 125m reel.		
2336 Support.		
2339 Cover.		
8214 Drive Shaft.		

2865 Twin chain connector (diameter 4.6mm)		C

10400 Cord retainer.		E

		Price Ctgy.
Optional Accessories		A
2006 Bottom bar 1m, 5m		
2016 Bottom bar 1m, 5m		
2048 Plastic bead chain (diameter 4.5mm) 100m reel		
2093 Ring		
2103T Transparent loop tape		
2109 Bottom Ring		
2144 Cross Rail		
2164 Ring Tape		
2333 Wheel for plastic bead chain		
2539 Touch and close pile section, 25m, 100m		
2616 Bracket (40.8mm)		
2872 Plastic bead chain (diameter 4.6mm) 100m reel		
3055 Hook		
3133 Bracket cover (60mm)		
3133L Bracket cover long.		
3134 Bracket (60mm)		
3135 Bracket (80mm)		
3136 Bracket (100mm)		
3137 Bracket (120mm)		
3138 Bracket (150mm)		
3139 Bracket (200mm)		
3139 Bracket (200mm)		
3340 cord weight white, each 10, 100.		
3340 cord weight grey, chrome, each 10, 100.		
4845BR Metal bead chain, brass		
Side-guide option available at an additional £37.60		

		Price Ctgy.
2330 System supplied ready assembled		A
Max curtain weight 4.5kg inc any weighting.		
Maximum width: 3.0m		
Maximum drop: 3.0m		
System width		
cms	£	
100	159.76	
125	178.64	
150	197.51	
175	216.36	
200	235.24	
225	253.30	
250	272.99	
275	291.84	
300	310.71	
Above prices are based on standard accessories detailed below.		

		Price Ctgy.
Standard Accessories		A
2221 Velcro Tape per m, 100m.		
2322 Pin.		
2327 Adapter.		
2216 Cord (diameter 0.85mm) 10m, 50m, 100m.		
2321 Profile.		
2323 Shell.		
2329 Adapter.		
2336 Sleeve.		
2337 End cover.		
2343 Universal bracket.		
4845 Steel bead chain (diameter 4.6mm) 125m reel.		
2326 Drive Case 4:1		
2325 Cover.		
8214 Drive Shaft.		
2046 Driving Pulley.		
2047 Driving Sleeve.		

2865 Twin chain connector (diameter 4.6mm)		C

10400 Cord retainer.		E

		Price Ctgy.
Optional Accessories		A
2006 Bottom bar 1m, 5m		
2016 Bottom bar		
2048 Plastic bead chain (diameter 4.5mm) 100m reel		
2093 Ring		
2103T Transparent loop tape		
2109 Eyelet		
2144 Cross Rail		
2164 Ring Tape		
2539 Touch and close pile section, 25m, 100m		
2616 Bracket (40.8mm)		
2872 Plastic bead chain (diameter 4.6mm) 100m reel		
3133 Bracket cover (60mm)		
3133L Bracket cover long.		
3134 Bracket (60mm)		
3135 Bracket (80mm)		
3136 Bracket (100mm)		
3137 Bracket (120mm)		
3138 Bracket (150mm)		
3139 Bracket (200mm)		
3055 Hook		
3340 cord weight white, each 10, 100.		
3340 cord weight grey, chrome, each 10, 100.		
4845BR Metal bead chain, brass		
Side-guide option available at an additional £37.60		



Austrian, Roman & Festoon Blind Systems

System 2350

Electrically Operated

For medium/heavy
Austrian, Roman
and Festoon
Blinds.

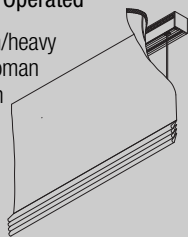

	Price Qty.																						
<p>Electrically operated System 2350 for straight vertically-hung Austrian, Roman and Festoon Blinds</p> <p>Total maximum curtain weight 15kg. Maximum width 6 metres. Maximum drop 6 metres, maximum total surface area 36m² depending on curtain weight. Minimum width 60cm.</p> <p>Hardware cost only.</p> <p>SYSTEM WIDTHS (cms) £</p> <table border="1"> <tr><td>100</td><td>636.10</td></tr> <tr><td>150</td><td>667.02</td></tr> <tr><td>200</td><td>697.98</td></tr> <tr><td>250</td><td>728.94</td></tr> <tr><td>300</td><td>759.89</td></tr> <tr><td>350</td><td>790.83</td></tr> <tr><td>400</td><td>821.80</td></tr> <tr><td>450</td><td>852.75</td></tr> <tr><td>500</td><td>883.70</td></tr> <tr><td>550</td><td>914.65</td></tr> <tr><td>600</td><td>945.60</td></tr> </table> <p>Components supplied separately. 2510 Velcro® insert rail (5 metre length).</p>	100	636.10	150	667.02	200	697.98	250	728.94	300	759.89	350	790.83	400	821.80	450	852.75	500	883.70	550	914.65	600	945.60	C
100	636.10																						
150	667.02																						
200	697.98																						
250	728.94																						
300	759.89																						
350	790.83																						
400	821.80																						
450	852.75																						
500	883.70																						
550	914.65																						
600	945.60																						
<p>3003 Clamp, 10, 100. 2093 Ring, 10, 100. 3055 Hook, each, 10.</p>	A																						
<p>Remote/Multiple System Operation</p> <p>For system operation possibilities refer to table on page 85</p>	C																						
<p>Side-guide option available at an additional cost of £53.57.</p> <p>System 9940 and 0450 Radio Controls are suitable for use with 2350. See page 26.</p>	C																						
<p>For Integrated Receiver for use with System 9940 controls, please add £148.95 to above prices.</p>	C																						

All prices shown
exclude VAT



Made-to-measure Roman Blinds

Prices below comprise the complete system made-to-measure, ready-to-hang on either System 2320 or 2330 with the chosen fabric.

Maximum width 3m, maximum drop 3m and maximum weight 4.5kg.

Width ► Drop ▼ cm	Breeze Freshtex Linlook Someo		Colorama 1 Freshtex Ultralight Sunset		Colorama 2 Natural Twist		Freshtex Light			Price Category 'C'			Width ▼ Drop ft/ins
	100cm 3'3"	120cm 3'11"	140cm 4'7"	160cm 5'3"	180cm 5'11"	200cm 6'6"	220cm 7'3"	240cm 7'10"	260cm 8'6"	280cm 9'2"	300cm 9'10"	325cm 10'8"	
90	378.40	412.97	447.42	482.10	516.65	551.20	585.77	620.33	654.87	689.42	723.99	767.18	2'11"
120	400.54	439.30	478.07	516.82	555.60	594.37	633.13	671.89	710.67	749.44	788.18	836.65	3'11"
140	422.64	465.63	508.61	551.59	594.57	637.55	680.51	723.48	766.46	809.44	852.40	904.60	4'7"
160	444.77	491.95	539.16	586.32	633.52	680.68	727.87	775.06	822.23	869.43	916.59	975.58	5'3"
180	466.91	518.31	569.68	621.09	672.47	723.87	775.25	826.65	878.03	929.42	980.81	1045.04	5'11"
200	489.03	544.63	600.25	655.84	711.45	767.03	822.61	878.22	933.81	989.42	1044.99	1114.52	6'6"
220	511.18	570.97	630.78	690.58	750.39	810.19	870.01	929.81	989.61	1049.41	1109.23	1183.97	7'3"
250	544.36	610.48	676.59	742.73	808.82	874.93	941.08	1007.16	1073.30	1139.39	1205.51	1288.18	8'2"

Width ► Drop ▼ cm	Colorama 1 Alu Newlife 1		Colorama 2 Bioactive Newlife 2		Deep Nightfall		Freshtex Dimout Reflex		Freshtex Vision Sevena			Width ▼ Drop ft/ins	
	100cm 3'3"	120cm 3'11"	140cm 4'7"	160cm 5'3"	180cm 5'11"	200cm 6'6"	220cm 7'3"	240cm 7'10"	260cm 8'6"	280cm 9'2"	300cm 9'10"		325cm 10'8"
90	472.28	523.56	574.83	626.13	677.42	728.69	779.97	831.24	882.53	933.80	985.10	1049.17	2'11"
120	505.52	563.19	620.91	678.59	736.31	794.00	851.69	909.39	967.07	1024.78	1082.47	1154.58	3'11"
140	538.73	602.87	666.97	731.10	795.19	859.31	923.42	987.54	1051.64	1115.78	1179.84	1260.02	4'7"
160	571.96	642.51	713.05	783.56	854.10	924.61	995.15	1065.67	1136.20	1206.76	1277.28	1365.45	5'3"
180	605.21	682.16	759.10	831.99	912.99	989.92	1066.88	1143.85	1220.78	1297.73	1374.67	1470.85	5'11"
200	638.43	721.79	805.15	888.54	971.88	1055.26	1138.59	1221.98	1305.35	1388.71	1472.06	1576.26	6'6"
220	671.66	761.44	851.23	941.03	1030.77	1120.57	1210.35	1300.15	1389.92	1479.67	1569.46	1681.69	7'3"
250	721.52	820.90	920.34	1019.72	1119.13	1218.53	1317.94	1417.35	1516.75	1616.17	1715.56	1839.82	8'2"

Please note that blinds with a total weight between 2.5kg and 4.5kg will be specified with System 2330 at an additional cost of £64.53. For manually operated blinds exceeding 4.5kg in weight please consult Silent Gliss for alternative systems.

Please note if 2350 electrically operated system is required please add £512.36 to the cost of the blinds above for standard motor. For integrated motor option for use with 9940 controls, please add £663.37.

ONLY the following fabrics can be lined. For a Blackout lining add 10%.
Deep, Freshtex Dimout, Reflex, Sunset.



Sliding Panels

System 2600 Panel Fold

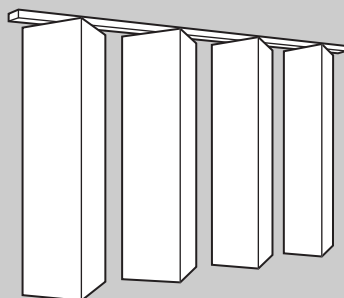

System 2640/2650 Panel Fold

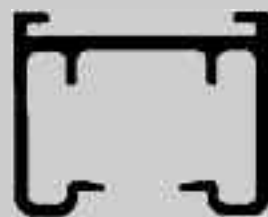

Silent Gliss Panel Fold Systems 2600, 2640 and 2650 are delivered made-to-measure, ready assembled in white.

To specify the complete system determine firstly the overall width of the system required. The actual sizes and quantities of panels are determined by special Silent Gliss software. However, in most circumstances there will be a choice between small, medium or large. You should also specify where panels need to be stacked in the open position; left, right or pair stack (same price applies for all stacking methods).

Panel Fold is only available as a complete system including fabric panels.

HARDWARE PRICES								Price Ctg.
System 2600 – Chain		System 2640 – Crank		System Electric (motor 9090)		System Electric (integrated radio receiver motor 9091)		C
	£		£		£		£	
150cm	302.36	150cm	347.72	150cm	1208.85	150cm	1344.47	
200cm	379.87	200cm	436.88	200cm	1284.29	200cm	1419.91	
250cm	457.43	250cm	526.05	250cm	1359.71	250cm	1495.35	
300cm	534.96	300cm	615.21	300cm	1435.17	300cm	1570.80	
324cm	612.48	350cm	704.37	350cm	1510.60	350cm	1646.24	
		400cm	793.54	400cm	1586.06	400cm	1721.69	
		450cm	882.69	450cm	1613.10	450cm	1797.12	
		500cm	972.29	500cm	1686.34	500cm	1872.56	

PRICES PER FABRIC PANEL (max 3m drop)

	Price Group 1	Price Group 2	Price Group 3	Price Group 4
Up to 60cm wide	£187.42	£214.42	£278.12	£413.17
Over 60cm wide	£241.45	£280.08	£383.02	£558.34

Recess profiles are available for both Panel Fold systems:

System 2600 - 2615 (or 2614 for suspended ceilings)

System 2650 - 2932

System 2640 - 2932

Fabric Price Group 1P

Breeze
Someo

Fabric Price Group 2P

Colorama 1
Colorama 1 Alu
Colorama 2
Freshtex Light
Freshtex Linlook
Freshtex Ultralight
Natural
Twist

Fabric Price Group 3P

Freshtex Dimout
Freshtex Vision
Linea
Newlife 1

Fabric Price Group 4P

Linea Alu
Newlife 2

All prices shown
exclude VAT



Sliding Panels

System 2700 Panel Glide



System 2730 Panel Flex

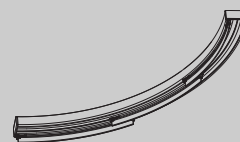

System 2760 Panel Flex

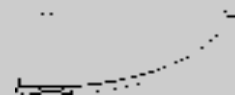

System 2700 is delivered made to measure, ready assembled in **white**, top fix as standard. Panels either hang freely or can be connected and operated via a draw rod or cord at no extra cost.

System 2730 and **2760** are delivered made to measure, ready assembled in **white**. Panels either hang freely or can be connected and operated via a draw rod.

The systems are built up from different profiles with between 2 and 5 channels. Please consult the Silent Gliss catalogue to ensure you order the correct profile depending on how many panels and which stacking variation you require. Some technical restrictions apply.

Panels are usually between 50cm and 100cm and we recommend they overlap by approximately 10cm-15cm.

System 2700 can be electrically operated in combination with System 5400. Please consult Silent Gliss for further information.

System 2730 and 2760 are only available as complete systems with fabric panels.

HARDWARE PRICES				Price Ctg.
System 2700 – Straight Only				C
	Manual			
150cm	£272.13			
200cm	£341.91			
250cm	£411.67			
300cm	£481.45			
350cm	£551.23			
400cm	£621.01			
450cm	£690.79			
500cm	£760.56			
550cm	£829.00			
600cm	£895.33			
PRICES PER FABRIC PANEL (max drop 3m)				
	Up to 60cm wide	60cm - 130cm wide		
Price Group 1	£187.41	£241.45		
Price Group 2	£214.40	£280.08		
Price Group 3	£278.11	£383.02		
Price Group 4	£413.17	£558.34		
FABRIC SUITABILITY				
Price Group 1	Price Group 2	Price Group 3	Price Group 4	
Breeze	Colorama 2	Alutex	Aluscreen Futura	
Colorama 1	Colorama 2 Alu	Alutrans Pro	Deep	
Colorama Alu 1	Freshtex Linlook	Colorama 2 Bioactive		
Element	Mercurio B	Freshtex Dimout		
Freshtex Light	Multi Shadow	Freshtex Vision		
Freshtex Ultralight	Multi Visio	Lightscreen		
Natural	Multiscreen 1%	Linea		
Someo	Multiscreen 5%	Linea Alu		
Sunset	Multiscreen 10%	Mica		
	Nightfall	Moon		
	Reflex	Newlife 1		
	Safescreen	Newlife 2		
	Treviscreen	Sevena		
	Triscreen 1%			
	Triscreen 3%			
	Triscreen 5%			
	Twist			
	Verascreen 1%			
	Verascreen 5%			
	Verascreen 10%			

Supplied with roller gliders as standard, available with optional click-in gliders at no extra cost.

Face fix brackets will carry an additional cost.

All prices shown exclude VAT

HARDWARE PRICES				Price Ctg.
System 2730 – Straight or Curved				C
	Manual			
150cm	£296.72			
200cm	£385.78			
250cm	£474.83			
300cm	£563.89			
350cm	£652.95			
400cm	£741.99			
450cm	£831.06			
500cm	£920.12			
550cm	£1009.17			
600cm	£1098.23			
PRICES PER FABRIC PANEL (max drop 3m)				
	Up to 60cm wide	60cm - 130cm wide		
Price Group 1	£187.41	£241.45		
Price Group 2	£214.40	£280.08		
Price Group 3	£278.11	£383.02		
Price Group 4	£413.17	£558.34		
FABRIC SUITABILITY				
Price Group 1	Price Group 2	Price Group 3		
Breeze	Colorama 1	Freshtex Dimout		
Someo	Colorama 1 Alu	Freshtex Vision		
	Colorama 2	Linea		
	Freshtex Light	Newlife 1		
	Freshtex Linlook	Sevena		
	Freshtex Ultralight	Linea Alu		
	Natural	Newlife 2		
	Reflex			
	Twist			

BENDS	Max. trade discount	25%
For each bend add the following to the above system price		
Gradual curve	£605.00	
Angle bend	£376.50	

System 2760

HARDWARE PRICES

Use base price for 2730 above and add components as required:

10356 Hanger Rod (up to 1.5m drop)	£71.49 each.
10357 V-Hanger Rod (up to 1.5m drop)	£115.85 each
10399 Design Fascia	£20.24 per metre, plus £3.31 per system
10333/4/5 End fix brackets	£10.54 each

All prices shown exclude VAT



Skylight Systems

System 2190

Crank Operated
For curved, sloping or horizontal Roman Blinds.

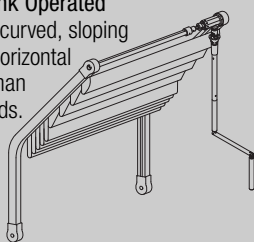

System 2195

Electrically Operated
For curved, sloping or horizontal Roman blinds.

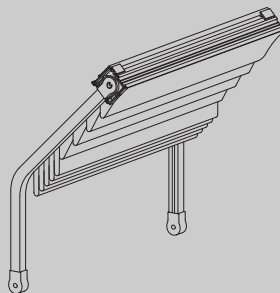

Made-to-measure Roman blinds for system 2190, 2195 and 8700

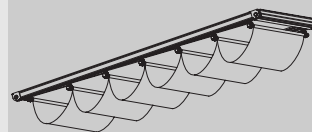

	Price Ctg.
--	---------------

System 2190 Crank operated

Single System:

Max. width: 2.5m. Max. drop: 6m.

Double System:

Max. width: 3m. Max. drop: 6m. These maximum sizes depend on the shape of system required – please check with Silent Gliss.

Max. fabric weight for both single/double system: 10kg. Prices below are for hardware only – for complete system cost please add price for fabric.

Single System Prices

Silver or white

Width > Drop (cms)	Up to 100cm £	101cm- 150cm £
150	704.66	747.17
200	781.45	823.97
250	858.25	900.77
300	935.09	977.56
350	1011.93	1054.33
400	1088.75	1131.25
450	1165.57	1208.06
500	1242.39	1284.85
550	1319.15	1361.73
600	1395.96	1438.48

Width > Drop (cms)	151cm- 200cm £	201cm- 250cm £
150	789.66	832.17
200	866.48	908.98
250	943.29	985.81
300	1020.15	1062.62
350	1096.95	1139.44
400	1173.72	1216.27
450	1250.54	1293.05
500	1327.35	1369.88
550	1404.21	1446.72
600	1480.99	1523.53

Double System Prices

Silver or white

If under 2500mm: Please add 30% to single system prices above.

Width > Drop (cms)	251cm- 300cm £	Width > Drop (cms)	251cm- 300cm £
150	1082.79	400	1558.37
200	1178.03	450	1653.54
250	1273.14	500	1748.67
300	1368.20	550	1843.74
350	1463.33	600	1938.88

Coloured side guide profiles:

For gold/black/bronze profiles please add:

	Single System	Double System	Treble System
Per m drop	£18.61	£37.26	£55.91
Per system	£14.20	£28.40	£43.97

Components

3825 Clamp, 10, 100.

2189 Gear

2230 Endpiece, white or grey.

2759 Rod.

5130 Belt.

2242 Connector.

2746 Detachable crank handle.

2156 Drive shaft.

3065a Bracket (single clamp)

3065b Bracket (double clamp)

2248 Cross rod.

Bending

Max. trade discount

25%

Add the following to above system price:

Radius/cm	Single System	Double System
25-99	£230.50	£461.00
Over 99	£438.00	£874.50

Please note: you will need to allow 2 bends per system.

All prices shown exclude VAT

	Price Ctg.
--	---------------

System 2195 Electrically Operated

Total max. curtain weight 25kg. (including cross profiles). Max. width: 3m. Max. drop: 6m.

Max. total surface area 15m² depending on curtain weight.

System 2195 is also available as a double and treble system with 2190 as a slave system.

Max width achievable with double system: 6m, with treble system: 6m, other max. data as above.

Profile 2191 can be bent to a 25cm min. radius.

Supplied complete, hardware only, partially assembled including recessed switch and cross rods.

Profile as standard in silver or white. For complete system cost please add price for fabric.

Single System Prices

Width > Drop (cms)	Up to 100cms £	101 cms- 150cms £	Silver or White 151 cms- 200 cms £	201 cms- 250 cms £	251 cms- 300 cms £
150	1907.61	1952.13	1996.69	2041.22	2085.75
200	1988.05	2032.62	2077.16	2121.71	2166.30
250	2068.57	2113.09	2157.62	2202.14	2246.71
300	2149.04	2193.55	2238.11	2282.64	2327.18
350	2229.52	2274.05	2318.58	2363.11	2407.65
400	2309.95	2354.51	2399.08	2443.60	2488.14
450	2390.44	2435.00	2479.55	2524.04	2568.59
500	2470.91	2515.45	2560.01	2604.54	2649.10
550	2551.41	2595.94	2640.49	2685.01	2729.59
600	2631.86	2676.41	2720.99	2765.49	2810.05

Double System Prices

Width > Drop (cms)	Up to 200cms £	201 cms- 300cms £	Silver or White 301 cms- 400 cms £	401 cms- 500 cms £
150	2382.19	2469.29	2556.34	2730.44
200	2539.51	2626.53	2713.65	2887.75
250	2696.80	2783.86	2870.95	3045.08
300	2854.11	2941.21	3028.22	3202.35
350	3011.38	3098.46	3185.50	3359.58
400	3168.68	3255.76	3342.78	3516.91
450	3325.95	3413.02	3500.09	3674.22
500	3483.25	3570.32	3657.39	3831.51
550	3640.55	3727.63	3814.64	3988.75
600	3797.88	3884.92	3971.95	4146.05

Treble System Prices

Width > Drop (cms)	Up to 300cms £	301 cms- 400cms £	Silver or White 401 cms- 500 cms £	501 cms- 600 cms £
150	2727.29	2856.85	2986.42	3051.24
200	2961.34	3090.97	3220.54	3285.30
250	3195.49	3325.11	3454.63	3519.41
300	3429.55	3559.12	3688.78	3753.53
350	3663.69	3793.26	3922.86	3987.66
400	3897.77	4027.37	4156.95	4221.74
450	4131.93	4261.48	4391.07	4455.84
500	4365.97	4495.60	4625.17	4689.94
550	4600.12	4729.72	4859.28	4924.04
600	4834.18	4963.79	5093.40	5158.16

For side guide profiles in gold, black, bronze add:

	Single System	Double System	Treble System
Per m drop	£18.54	£37.08	£56.14
Per system	£14.42	£27.30	£41.50

Components

3825 Clamp, 10, 100

2230 Set, white or grey

5130 Belt

2160 Motor

2759 Cross Rod

2242 Connector

2156 Drive Shaft

2248 Cross Rod

2145 Telescopic glider

3065a Bracket (single clamp) silver or white

3066b Bracket (double clamp) silver or white

Bending

Add the following to above system price:

Radius/cm	Single System	Double System	Treble System
25-99	£230.00	£461.50	£691.50
over 99	£437.00	£875.50	£1320.00

	Price Ctg.
--	---------------

Fabric for curved, sloping or horizontal Skylight Systems 2190/2195/8700.

Made-to-measure Roman Blind for Systems 2190/2195.

Prices for made-up-blind, without hardware, per square metre.

Aluscreen Futura	£204.00 m ²
Alutex	£161.50 m ²
Colorama 1	£135.50 m ²
Colorama 2	£161.50 m ²
Colorama 2 Bioactive	£187.00 m ²
Deep	£204.00 m ²
Freshtex Dimout	£187.00 m ²
Freshtex Vision	£161.50 m ²
Multiscreen 1%	£187.00 m ²
Multiscreen 5%	£187.00 m ²
Multiscreen 10%	£161.50 m ²
Triscreen 1%	£187.00 m ²
Triscreen 3%	£187.00 m ²
Triscreen 5%	£187.00 m ²
Newlife 1	£187.00 m ²
Newlife 2	£187.00 m ²
Reflex	£161.50 m ²
Sevena	£187.00 m ²
Sunset	£135.50 m ²
Verascreen 1%	£187.00 m ²
Verascreen 5%	£187.00 m ²
Verascreen 10%	£161.50 m ²



Skylight Systems

System 8600

Electrically Operated
tension roller blind.

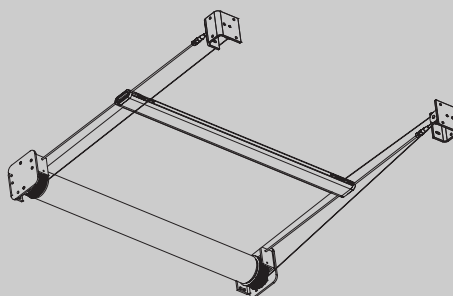

Systems 8600

Electrically operated tensioned roller blind system.

Max. width: 4m. Max. drop: 6.5m

System 8600 with Multiscreen 5% / Verascreen 5%

Price Category 'C'

Width ► Drop ▼	110cm 3'6"	150cm 4'11"	200cm 6'6"	250cm 8'2"	300cm 9'10"	350cm 11'6"	400cm 13'1"	◀ Width ▼ Drop
100	2303.57	2326.49	2491.06	2514.31	2673.55	2702.17	2730.79	3'3"
150	2327.81	2359.50	2535.09	2569.33	2739.62	2791.29	2818.83	4'11"
200	2352.02	2392.51	2579.11	2624.38	2805.63	2856.29	2906.90	6'6"
250	2376.23	2425.55	2623.13	2679.39	2871.68	2933.33	2994.97	8'2"
300	2400.46	2458.55	2667.16	2734.44	2937.72	3010.38	3083.02	9'10"
350	2529.85	2596.79	2811.07	2894.73	3111.62	3192.59	3276.25	11'6"
400	2554.06	2629.80	2855.08	2949.75	3201.83	3269.65	3364.32	13'1"
450	2578.27	2662.82	2899.11	3004.79	3241.04	3346.70	3452.36	14'9"
500	2602.50	2695.84	2943.16	3059.83	3307.06	3423.75		16'5"
550	2626.71	2728.86	2987.17	3114.86	3373.12	3500.79		18'0"
600	2650.94	2761.90	3031.22	3169.91	3439.14			19'8"
650	2675.14	2794.90	3075.25	3224.94	3505.20			21'3"

System 8600 with Aluscreen Futura / Lightscreen / Safescreen

Price Category 'C'

Width ► Drop ▼	110cm 3'6"	150cm 4'11"	200cm 6'6"	250cm 8'2"	300cm 9'10"	350cm 11'6"	400cm 13'1"	◀ Width ▼ Drop
100	2328.75	2360.79	2536.77	2571.72	2742.16	2782.46	2822.24	3'3"
150	2362.62	2406.97	2598.39	2648.45	2834.54	2890.00	2945.46	4'11"
200	2396.53	2453.20	2660.00	2725.49	2926.98	2997.83	3068.68	6'6"
250	2430.40	2526.25	2721.62	2775.64	3019.38	3105.65	3191.92	8'2"
300	2464.28	2545.62	2783.22	2879.52	3111.82	3213.35	3315.12	9'10"
350	2603.34	2697.02	2944.71	3061.77	3309.40	3426.76	3543.54	11'6"
400	2637.24	2743.23	3006.59	3138.78	3401.82	3534.29	3666.76	13'1"
450	2671.13	2789.42	3067.94	3215.78	3494.25	3642.11	3789.98	14'9"
500	2705.02	2835.62	3129.55	3292.82	3586.67	3749.95		16'5"
550	2738.90	2881.85	3191.16	3369.83	3679.10	3857.76		18'0"
600	2799.64	2928.06	3252.78	3446.86	3771.50			19'8"
650	2806.67	2974.25	3314.36	3523.86	3863.91			21'3"

Motor is fitted as standard to the left. Should you require a right hand motor there will be an additional cost of £167.87.

Profiles are standard in white (RAL 9016). Alternative colours are available at a cost of £522.55 (nett Cat E) for orders of 1-10 systems (there will be no charge for orders for 11 systems or more).

All prices shown exclude VAT



Skylight Systems

System 8700

Electrically Operated
Roman blind system
for large glass roofs.

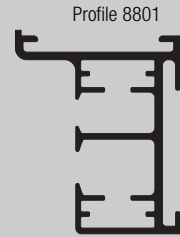
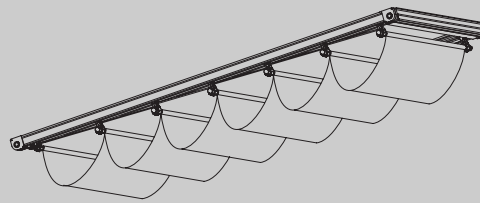

Systems 8700

Electrically operated Roman blind system.

Max. width: 5m. Max. drop: 12m. Max. m²: 50

Note: maximum width between side channels is 3m.

Prices below are for hardware only. For the full system price please add the fabric costs which can be found on Page 32.

System 8700 - Hardware Only

Price Category 'C'

Width ► Drop ▼	Folds	100cm 3'3"	125cm 4'1"	150cm 4'11"	175cm 5'8"	200cm 6'6"	225cm 7'4"	250cm 8'2"	275cm 9'0"	300cm 9'10"	Width ► Drop ▼
400	10	2665.50	2718.06	2770.62	2823.16	2875.70	2928.28	2980.83	3033.38	3085.91	13'1"
450	11	2805.29	2862.03	2918.79	2975.56	3032.33	3089.08	3145.85	3202.58	3259.35	14'9"
500	12	2945.10	3006.04	3067.01	3127.98	3188.94	3249.90	3310.86	3371.82	3432.78	16'5"
550	14	3065.94	3130.07	3194.17	3258.30	3322.43	3386.51	3450.63	3514.75	3578.88	18'0"
600	15	3186.83	3254.11	3321.35	3388.62	3455.90	3523.17	3590.43	3657.71	3724.95	19'8"
650	16	3398.08	3469.58	3541.03	3612.50	3683.98	3755.44	3826.92	3898.41	3969.88	21'3"
700	17	3732.33	3685.02	3760.73	3836.38	3912.08	3987.73	4063.43	4139.09	4214.74	22'11"
750	19	3609.37	3812.21	3892.09	3971.97	4051.83	4131.73	4211.63	4291.48	4371.38	24'6"
800	20	3855.29	3939.39	4023.48	4107.56	4191.64	4275.72	4359.80	4443.89	4527.98	26'2"
850	21	3995.09	4082.34	4169.56	4256.80	4344.04	4431.28	4518.54	4605.76	4693.01	27'9"
900	22	4134.89	4225.29	4315.68	4406.06	4496.45	4586.84	4677.24	4767.62	4858.02	29'5"
950	24	4257.84	4351.40	4444.94	4538.50	4632.04	4725.58	4819.11	4912.68	5006.22	31'0"
1000	25	4380.85	4477.53	4574.23	4670.92	4767.62	4864.47	4961.03	5057.71	5154.41	32'8"
1050	26	4518.54	4620.48	4722.44	4824.38	4926.35	5028.30	5130.23	5232.20	5334.14	34'3"
1100	27	4656.21	4763.41	4870.64	4977.84	5085.04	5192.26	5299.48	5406.66	5513.90	35'11"
1150	29	4779.20	4889.56	4999.92	5110.27	5220.62	5331.01	5441.36	5551.71	5662.06	37'1"
1200	30	4902.15	5015.67	5129.17	5242.70	5356.22	5469.72	5583.24	5696.75	5810.29	38'9"
Additional Fold		33.64	35.74	37.83	39.94	42.05	44.14	46.25	48.35	50.45	

System 8700 - Hardware only

Price Category 'C'

Width ► Drop ▼	Folds	325cm 10'10"	350cm 11'6"	375cm 12'4"	400cm 13'1"	425cm 13'11"	450cm 14'9"	475cm 15'7"	500cm 16'5"	Width ► Drop ▼
400	10	3115.64	3145.41	3175.15	3204.91	3234.63	3264.41	3294.15	3323.89	13'1"
450	11	3292.08	3324.80	3357.49	3390.22	3422.94	3455.68	3488.38	3521.09	14'9"
500	12	3468.47	3504.16	3539.86	3575.56	3611.26	3646.96	3682.62	3718.33	16'5"
550	14	3620.50	3662.15	3703.81	3745.43	3787.09	3828.75	3870.37	3912.02	18'0"
600	15	3769.59	3814.21	3858.81	3903.44	3948.05	3992.68	4037.29	4081.90	19'8"
650	16	4017.46	4065.05	4112.66	4160.23	4207.83	4255.41	4303.02	4350.61	21'3"
700	17	4265.33	4315.89	4366.45	4417.02	4467.59	4518.18	4568.73	4619.30	22'11"
750	19	4427.90	4484.40	4540.90	4597.45	4653.94	4710.46	4766.99	4823.50	24'6"
800	20	4587.47	4646.97	4706.45	4765.91	4825.42	4884.92	4944.41	5003.92	26'2"
850	21	4755.46	4817.93	4880.39	4942.86	5005.33	5067.79	5130.23	5192.71	27'9"
900	22	4923.43	4988.90	5054.34	5119.77	5185.20	5250.66	5316.10	5381.53	29'5"
950	24	5077.59	5148.02	5220.37	5291.75	5363.16	5434.54	5505.93	5577.32	31'0"
1000	25	5228.78	5303.15	5377.51	5451.86	5526.24	5600.57	5674.96	5749.33	32'8"
1050	26	5411.49	5488.81	5566.17	5643.49	5720.84	5798.18	5875.52		34'3"
1100	27	5594.19	5674.50	5754.80	5835.15	5915.44	5995.74			35'11"
1150	29	5748.33	5834.59	5920.84	6007.15	6093.40				37'1"
1200	30	5899.51	5988.75	6077.99	6167.22					38'9"
Additional Fold		52.56	54.66	56.76	58.85	60.95	63.07	65.17	67.28	

Profiles are white as standard. An additional cost will apply for alternative colours.

Intermediate Bracket

There is an additional cost for intermediate brackets for side-by-side systems. The brackets are priced at £30.00 each and the table below indicates how many brackets would be needed.

System Length	No. required	Total Cost £	System Length	No. required	Total Cost £	System Length	No. required	Total Cost £
4.0m	7	210.00	7.0m	12	360.00	10.0m	17	510.00
4.5m	8	240.00	7.5m	13	390.00	10.5m	18	540.00
5.0m	9	270.00	8.0m	14	420.00	11.0m	19	570.00
5.5m	10	300.00	8.5m	15	450.00	11.5m	20	600.00
6.0m	10	300.00	9.0m	15	450.00	12.0m	20	600.00
6.5m	11	333.00	9.5m	16	480.00			

Installation

An additional charge will be calculated for installation which may include access equipment and custom brackets.

All prices shown exclude VAT



Skylight Systems

System 8800

Electrically Operated heavy duty glass roof shading system.

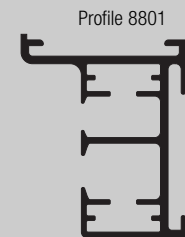
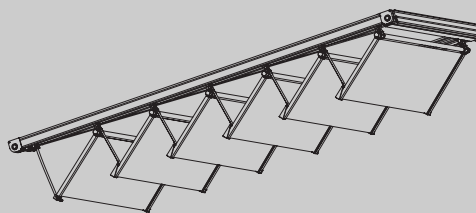

Systems 8800

Electrically operated heavy duty glass roof shading system.
Max. width: 3m. Max. drop: 12m. Max. m²: 36

System 8800 with Alutex or Safescreen

Price Category 'C'

Width ► Drop ▼	100cm 3'3"	125mm 4'1"	150cm 4'11"	175mm 5'8"	200cm 6'6"	225mm 7'4"	250cm 8'2"	275mm 9'0"	300cm 9'10"	◀ Width ▼ Drop
400	5527.02	5647.97	5795.23	5937.22	6084.48	6200.18	6347.41	6489.40	6636.65	13'1"
450	5884.65	6037.15	6184.39	6331.62	6505.16	6652.42	6804.93	6952.18	7125.73	14'9"
500	6221.19	6373.70	6552.49	6699.75	6878.55	7031.06	7209.87	7362.37	7535.91	16'5"
550	6573.54	6757.60	6941.65	7125.73	7315.03	7499.11	7683.14	7867.21	8051.28	18'0"
600	6899.59	7094.17	7288.74	7478.06	7698.93	7888.23	8082.83	8277.41	8493.01	19'8"
650	7346.60	7546.44	7767.31	7993.43	8214.30	8414.13	8635.01	8855.87	9081.99	21'3"
700	7772.54	7998.68	8224.81	8456.21	8682.32	8908.46	9139.85	9365.98	9592.11	22'11"
750	8124.91	8361.56	8619.23	8855.87	9113.55	9344.94	9607.89	9839.28	10096.95	24'6"
800	8456.21	8698.11	8966.30	9229.25	9497.45	9734.10	10002.29	10265.23	10533.44	26'2"
850	8813.81	9081.99	9355.47	9623.67	9918.15	10191.62	10459.83	10733.28	11027.77	27'9"
900	9145.10	9418.58	9718.32	9997.05	10296.81	10570.24	10875.28	11148.72	11448.48	29'5"
950	9555.31	9865.58	10175.83	10480.85	10791.11	11096.14	11406.40	11716.67	12021.71	31'0"
1000	9944.43	10259.96	10580.77	10917.34	11232.86	11553.65	11869.21	12205.75	12526.54	32'8"
1050	10302.05	10649.15	10975.18	11322.28	11669.33	12021.71	12342.47	12694.81	13041.91	34'3"
1100	10633.36	10990.95	11343.29	11700.91	12058.50	12416.09	12768.45	13126.05	13483.65	35'11"
1150	10985.70	11348.55	11732.46	12095.30	12479.22	12836.81	13225.94	13583.56	13967.44	37'1"
1200	11317.00	11706.18	12069.03	12458.17	12847.30	13236.48	13604.60	13993.73	14377.65	38'9"

Profiles are white as standard. An additional cost will apply for alternative colours.

Intermediate Bracket

There is an additional cost for intermediate brackets for side-by-side systems. The brackets are priced at £30.00 each and the table below indicates how many brackets would be needed.

System Length	No. required	Total Cost £
4.0m	7	210.00
4.5m	8	240.00
5.0m	9	270.00
5.5m	10	300.00
6.0m	10	300.00
6.5m	11	333.00
7.0m	12	360.00
7.5m	13	390.00
8.0m	14	420.00
8.5m	15	450.00
9.0m	15	450.00
9.5m	16	480.00
10.0m	17	510.00
10.5m	18	540.00
11.0m	19	570.00
11.5m	20	600.00
12.0m	20	600.00

Installation

An additional charge will be calculated for installation which may include access equipment and custom brackets.

All prices shown exclude VAT



Vertical Blinds

Vertical Waves by Eva Marmbrandt

Suitable for use on systems 2810, 2900, 2950.

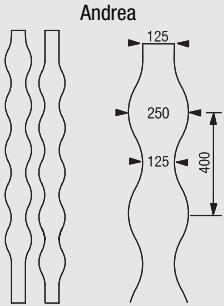

Andrea

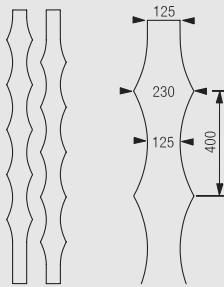

Annika

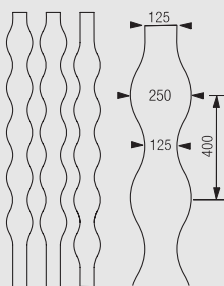

Maria

Fabric Price Group 3 Made in Visiotex

Minimum and maximum system length as per individual system information.

Minimum louvre drop 104cm (127mm)
Maximum louvre drop 423cm (127mm)

Minimum louvre drop 110cm (89mm)
Maximum louvre drop 364cm (89mm)

Minimum distance from wall 140mm
Not suitable for sloping applications.
Can be bent to large radius >6m.

Available as 89mm or 127mm louvres.

System 2810

Profile only 2601 available in 6 metre lengths.
Cannot be bent. Headrail available in silver and white.

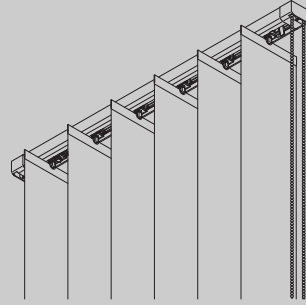

System 2810

Track and Accessories only

Maximum system length: 50 rotation elements, (max. 5m dependent on louvre width)

For guidance the following number of louvres per metre should be calculated:

127mm/5"	10/metre
89mm/3 1/2"	13/metre

Track system only complete, assembled, ready to hang.

Hardware only: in silver or white, no fabrics. Excluding bottom weights and link chain but including Top clips and 2616 bracket clamps. Operating chain 150cm standard. Wall fix brackets extra. Prices given are for 127mm/5" louvres. For 89mm/3 1/2" louvres add 30%. Includes cord weight 3340.

Width up to cm/ft. ins.	£	Price Ctg.
60/2'0"	83.80	C
80/2'7"	99.33	
100/3'3"	114.88	
120/3'11"	130.41	
140/4'7"	145.90	
160/5'3"	161.41	
180/5'11"	176.91	
200/6'6"	192.42	
220/7'3"	207.95	
240/7'10"	223.47	
260/8'6"	238.91	
280/9'2"	254.47	
300/9'10"	270.00	
320/10'6"	285.47	
340/11'2"	301.03	
360/11'10"	316.53	
380/12'6"	332.02	
400/13'1"	347.53	
420/13'9"	363.08	
440/14'5"	378.61	
460/15'1"	394.14	
480/15'9"	409.69	
500/16'5"	425.23	

Standard Accessories

- 2601 Profile only, silver or white.
- 2604 Guide.
- 2605 Top clip 127mm white.
- 2608 Endstop for 2601.
- 2610 Endstop.
- 2611 Stopper.
- 2616 Bracket.
- 2620 Pilot runner.
- 2623 Rotation element (123mm).
- 2625 Rotation element (89mm).
- 2813 Top clip 89mm white.
- 2865 Bead chain connector.
- 2872 Operating chain.
- 3340 Cord weight, white, each, 10, 100.
- 10400 Cord tidy

Optional Accessories

- 2471 Bottom weight 127mm.
- 2473 Bottom weight 89mm.
- 2481 Louvre connecting chain 127mm.
- 2479 Louvre connecting chain 89mm.
- 2606 Top clip 127mm (modified).
- 2607 Top clip 89mm (modified).
- 2614 Recess profile (suspended ceilings)
- 2615 Recess profile.
- 2618 Shaft.
- 2624 Adjustment element (101mm).
- 2824 Spacer (65mm).
- 3340 Cord weight, each grey/chrome.
- 5118 Wedge.
- 6268 Hanger.

- 3133 Bracket cover (60mm).
- 3133L Extended bracket cover (100mm).
- 3135-8 Extension bracket.

Fabric price categories

For System 2810 complete with fabrics (see tables over)

Price Group 1

- Element
- Function

Price Group 2

- Alutex
- Colorama 2
- Mercurio B
- Multi Shadow
- Multi Visio
- Multiscreen 5%
- Versascreen 1%
- Versascreen 5%
- Versascreen 10%

Price Group 3

- Alutrans Pro
- Moon
- Reflex
- Vertical Wave
- Colorama 2 Bioactive

All fabrics are available in 89mm and 127mm louvres.

All above fabrics are FR.

All prices shown exclude VAT



System 2810 complete with fabric

The prices below comprise complete system, silver or white ready-to-hang, top fix, single or pair stack with fabric choice in 127mm/5" louvres (see fabric price categories). Includes bottom weights and bottom link cord to both sides. Wall fix brackets extra. For 89mm/3 1/2" louvres add 30%. If sizes lie between the measurements shown, the price for the next larger will apply.

Price Category C

Width	UP TO 60/2'0"			UP TO 80/2'7"			UP TO 100/3'3"			UP TO 120/3'11"			Width
	1	2	3	1	2	3	1	2	3	1	2	3	
Drop cm													Drop ft.ins.
60	118.36	133.00	148.77	145.41	164.86	185.94	172.42	196.74	223.11	199.42	228.63	260.26	2'0"
80	123.67	143.13	164.18	152.45	178.39	206.48	181.21	213.64	248.76	210.01	248.90	291.05	2'7"
100	128.95	153.23	179.58	159.46	191.89	227.00	189.98	230.56	273.87	220.55	269.19	321.85	3'3"
120	134.23	163.37	194.99	166.52	205.40	247.54	198.79	247.42	300.12	231.08	289.44	352.66	3'11"
140	139.49	173.53	210.42	173.53	218.91	268.11	207.55	264.31	325.80	241.59	309.68	383.49	4'7"
160	144.75	183.65	225.82	180.52	232.43	288.63	216.36	281.20	351.44	252.14	329.95	414.30	5'3"
180	150.03	193.78	241.18	187.56	245.88	309.18	225.12	298.09	377.11	262.69	350.21	445.10	5'11"
200	155.26	203.92	256.60	194.57	259.44	329.71	233.94	314.94	402.80	273.29	370.53	475.90	6'6"
220	160.54	214.04	272.03	201.62	272.97	350.22	242.70	331.87	428.49	283.78	390.78	506.69	7'3"
240	165.81	224.21	287.45	208.68	286.49	370.79	251.50	348.77	454.20	294.28	411.03	537.51	7'10"
260	171.07	234.35	302.82	215.67	299.99	391.33	260.27	365.65	479.86	304.83	431.30	568.34	8'6"
280	176.37	244.44	318.23	222.67	313.47	411.91	269.05	382.56	505.54	315.39	451.59	599.14	9'2"
300	181.63	254.61	333.66	229.74	326.97	432.45	277.83	399.43	531.18	325.96	471.84	629.99	9'10"
320	186.90	264.71	349.08	236.79	340.51	452.92	286.61	416.30	556.89	336.50	492.12	660.81	10'6"
340	192.19	274.83	364.46	243.80	354.01	473.48	295.40	433.19	582.52	347.02	512.33	691.61	11'2"
360	197.44	285.01	379.84	250.84	367.52	494.03	304.18	450.11	608.23	357.55	532.65	722.42	11'10"
380	202.73	295.14	395.27	257.81	381.02	514.58	312.99	466.96	633.86	368.12	552.95	753.20	12'6"
400	207.97	305.25	410.65	264.86	394.53	535.12	321.77	483.86	659.55	378.64	573.15	783.99	13'1"

Width	UP TO 140/4'7"			UP TO 160/5'3"			UP TO 180/5'11"			UP TO 200/6'6"			Width
	1	2	3	1	2	3	1	2	3	1	2	3	
Drop cm													Drop ft.ins.
60	226.47	260.51	297.41	253.46	292.39	334.55	280.52	324.30	371.72	307.54	356.16	408.88	2'0"
80	238.76	284.13	333.37	267.56	319.41	375.64	296.30	354.64	417.93	325.14	389.98	460.23	2'7"
100	251.10	307.87	369.28	281.59	346.46	416.70	312.14	385.08	464.15	342.64	423.72	511.57	3'3"
120	263.37	331.45	405.23	295.66	373.49	457.82	327.94	415.49	510.34	360.23	457.51	562.93	3'11"
140	275.65	355.06	441.15	309.69	400.49	498.87	343.73	445.91	556.54	377.81	491.31	614.28	4'7"
160	287.97	378.76	477.10	323.76	427.50	539.93	359.56	476.30	602.80	395.40	525.08	665.59	5'3"
180	300.23	402.39	513.07	337.82	454.55	581.03	375.39	506.66	649.01	412.97	558.84	716.93	5'11"
200	312.55	426.05	549.03	351.87	481.55	622.11	391.19	537.10	695.21	430.53	592.59	768.32	6'6"
220	324.85	449.70	584.94	365.95	508.59	663.18	406.96	567.52	741.44	448.07	626.42	819.66	7'3"
240	337.12	473.31	620.89	380.02	535.65	704.27	422.84	597.93	787.61	465.64	660.19	871.02	7'10"
260	349.45	496.98	656.81	394.05	562.63	745.35	438.63	628.34	833.85	483.21	693.94	922.38	8'6"
280	361.75	520.62	692.80	408.08	589.64	786.43	454.41	658.71	880.06	500.80	727.72	973.71	9'2"
300	374.05	544.27	728.73	422.12	616.65	827.50	470.23	689.11	926.24	518.36	761.50	1025.04	9'10"
320	386.36	567.93	764.66	436.17	643.70	868.59	486.06	719.54	972.53	535.88	795.32	1076.41	10'6"
340	398.61	591.54	806.29	450.27	670.77	909.68	501.91	749.92	1018.71	553.50	829.12	1127.78	11'2"
360	410.93	615.22	836.57	464.32	697.76	950.76	517.70	780.35	1064.94	571.06	862.85	1179.11	11'10"
380	423.22	638.87	872.51	478.38	724.78	991.82	533.49	810.67	1111.13	588.65	896.66	1230.44	12'6"
400	435.56	662.54	908.44	492.41	751.80	1032.88	549.29	841.11	1157.34	606.19	930.44	1244.45	

Width	UP TO 220/7'3"			UP TO 240/7'10"			UP TO 260/8'6"			UP TO 280/9'2"			Width
	1	2	3	1	2	3	1	2	3	1	2	3	
Drop cm													Drop ft.ins.
60	334.54	388.06	446.04	361.53	419.92	483.17	388.60	451.81	520.31	415.61	483.70	557.48	2'0"
80	353.90	425.18	502.52	382.66	460.45	544.80	411.39	495.73	587.09	440.22	530.97	629.39	2'7"
100	373.20	462.36	558.97	403.76	501.00	606.39	434.25	539.66	653.79	464.84	578.26	701.27	3'3"
120	392.53	499.52	615.48	424.81	541.55	668.03	457.14	583.57	720.61	489.38	625.56	773.17	3'11"
140	411.86	536.69	671.96	445.91	582.05	729.64	479.95	627.47	787.33	513.99	672.88	845.03	4'7"
160	431.16	573.84	728.44	466.96	622.60	791.25	502.79	671.35	854.08	538.59	720.17	916.93	5'3"
180	450.51	611.00	784.92	488.06	663.12	852.90	525.64	715.28	920.84	563.17	767.45	988.84	5'11"
200	469.82	648.18	841.44	509.16	703.69	914.51	548.46	759.18	987.62	587.74	814.73	1060.68	6'6"
220	489.11	685.37	897.87	530.24	744.24	976.09	571.27	803.15	1054.32	612.39	862.06	1132.58	7'3"
240	508.46	722.47	954.38	551.30	784.74	1037.77	594.16	847.02	1121.09	636.97	909.34	1204.45	7'10"
260	527.78	759.61	1010.82	572.41	825.28	1099.39	616.99	890.95	1187.89	661.57	956.61	1276.33	8'6"
280	547.13	796.78	1067.32	593.44	865.83	1161.00	639.84	934.85	1254.60	686.14	1003.89	1348.26	9'2"
300	566.47	833.95	1123.83	614.57	906.36	1222.59	662.63	978.82	1321.38	710.75	1051.19	1420.12	9'10"
320	585.76	871.11	1180.28	635.62	946.92	1284.20	685.50	1022.72	1388.10	735.35	1098.50	1492.02	10'6"
340	605.14	908.26	1236.77	656.73	987.42	1345.82	708.35	1066.63	1454.85	759.94	1145.79	1563.91	11'2"
360	624.41	945.40	1293.27	677.81	1027.97	1407.47	731.17	1110.49	1521.66	784.54	1193.09	1635.79	11'10"
380	643.74	982.59	1349.74	698.89	1068.49	1469.05	754.01	1154.44	1588.37	809.15	1240.38	1707.71	12'6"
400	663.07	1019.73	1406.21	719.99	1109.05	1530.71	776.90	1198.35	1655.13	833.74	1287.65	1779.58	13'1"

All prices shown exclude VAT



System 2810 complete with fabric

The prices below comprise complete system, silver or white ready-to-hang, top fix, single or pair stack with fabric choice in 127mm/5" louvres (see fabric price categories). Includes bottom weights and bottom link cord to both sides. Wall fix brackets extra. For 89mm/3 1/2" louvres add 30%. If sizes lie between the measurements shown, the price for the next larger will apply.

Price Category C

Width	UP TO 300/9'10"			UP TO 320/10'6"			UP TO 340/11'2"			UP TO 360/11'10"			Width
	1	2	3	1	2	3	1	2	3	1	2	3	
Drop cm													Drop ft.ins.
60	442.63	515.62	594.66	469.65	547.47	631.79	496.69	579.34	668.92	523.66	611.21	706.12	2'0"
80	468.97	566.25	671.68	497.77	601.48	713.94	526.52	636.76	756.26	555.31	672.04	798.52	2'7"
100	495.33	616.96	748.69	525.87	655.58	796.13	556.42	694.21	843.52	586.90	732.82	890.95	3'3"
120	521.68	667.59	825.70	553.94	709.61	878.27	586.27	751.62	930.78	618.58	793.64	983.40	3'11"
140	548.06	718.26	902.74	582.10	763.61	960.43	616.13	809.08	1018.11	650.19	854.46	1075.79	4'7"
160	574.38	768.97	979.73	610.17	817.69	1042.56	646.01	866.47	1105.40	681.81	915.23	1168.22	5'3"
180	600.77	819.61	1056.75	638.36	871.73	1124.70	675.84	923.90	1192.73	713.41	976.06	1260.65	5'11"
200	627.08	870.25	1133.77	666.40	925.81	1206.92	705.76	981.33	1280.04	745.07	1036.86	1353.08	6'6"
220	653.49	920.94	1210.85	694.50	979.86	1289.05	735.63	1038.77	1367.30	776.67	1097.65	1445.62	7'3"
240	679.81	971.58	1287.86	722.66	1033.89	1371.33	765.49	1096.19	1454.57	808.31	1158.49	1537.97	7'10"
260	706.17	1022.28	1364.88	750.77	1087.93	1453.39	795.36	1153.60	1541.88	839.90	1219.27	1630.38	8'6"
280	732.52	1072.92	1441.90	778.90	1141.99	1535.54	825.18	1211.03	1629.16	871.57	1280.08	1722.82	9'2"
300	758.88	1123.60	1518.92	806.93	1196.04	1617.71	855.08	1268.48	1716.51	903.15	1340.87	1815.24	9'10"
320	785.23	1174.29	1595.93	835.04	1250.06	1699.85	884.89	1325.89	1803.74	934.78	1401.69	1907.66	10'6"
340	811.58	1224.94	1672.94	863.20	1304.12	1782.01	914.79	1383.31	1891.04	966.45	1462.49	2000.11	11'2"
360	837.92	1275.67	1749.99	891.29	1358.18	1864.17	944.67	1440.72	1978.30	998.03	1523.31	2092.52	11'10"
380	864.26	1326.29	1827.02	919.43	1412.22	1946.31	974.53	1498.12	2065.63	1029.69	1584.12	2184.95	12'6"
400	890.63	1376.96	1904.02	947.52	1466.29	2028.47	1004.38	1555.62	2152.90	1061.30	1644.90	2277.36	13'1"

Width	UP TO 380/12'6"			UP TO 400/13'1"			UP TO 420/13'9"			UP TO 440/14'5"			Width
	1	2	3	1	2	3	1	2	3	1	2	3	
Drop cm													Drop ft.ins.
60	550.71	643.10	743.25	577.73	674.98	780.40	604.79	706.91	817.54	631.75	738.76	854.72	2'0"
80	584.09	707.31	840.86	612.85	742.57	883.11	641.65	777.83	925.38	670.40	813.07	967.71	2'7"
100	617.50	771.49	938.39	647.98	810.12	985.81	678.53	848.75	1033.23	709.06	887.40	1080.66	3'3"
120	650.84	835.68	1035.95	683.15	877.66	1088.48	715.43	919.67	1141.05	747.72	961.72	1193.63	3'11"
140	684.27	899.86	1133.50	718.27	945.24	1191.17	752.32	990.60	1248.88	786.38	1036.02	1306.60	4'7"
160	717.61	964.03	1231.05	753.40	1012.78	1293.87	789.22	1061.59	1356.74	825.03	1110.34	1419.54	5'3"
180	750.99	1028.21	1328.61	788.57	1080.37	1396.57	826.09	1132.49	1464.59	863.67	1184.65	1532.54	5'11"
200	784.38	1092.38	1426.18	823.69	1147.89	1499.27	862.99	1203.48	1572.40	902.35	1258.98	1645.33	6'6"
220	817.76	1156.59	1523.76	858.82	1215.44	1601.99	899.93	1274.41	1680.13	940.97	1333.28	1758.40	7'3"
240	851.18	1220.78	1621.34	893.95	1283.03	1704.68	936.80	1345.29	1788.04	979.64	1407.58	1871.42	7'10"
260	884.52	1284.94	1718.89	929.08	1350.56	1807.37	973.71	1416.30	1895.90	1018.28	1481.91	1984.38	8'6"
280	917.88	1349.10	1816.45	964.24	1418.16	1910.09	1010.62	1487.19	2003.73	1056.94	1556.23	2097.34	9'2"
300	951.30	1413.28	1913.99	999.34	1482.42	2012.77	1047.46	1558.13	2111.55	1095.59	1630.53	2210.31	9'10"
320	984.65	1477.48	2011.55	1034.48	1553.28	2115.52	1084.35	1629.07	2219.36	1134.17	1704.85	2323.31	10'6"
340	1018.04	1541.67	2109.11	1069.66	1620.85	2218.20	1121.23	1699.99	2327.23	1172.87	1779.18	2436.23	11'2"
360	1051.44	1605.85	2206.70	1104.78	1688.41	2320.88	1158.18	1771.01	2435.05	1211.52	1853.54	2549.24	11'10"
380	1084.79	1670.07	2304.26	1139.91	1755.95	2423.58	1195.00	1841.87	2542.89	1250.16	1927.82	2662.17	12'6"
400	1118.18	1734.18	2401.78	1175.04	1823.53	2526.26	1231.94	1912.81	2650.73	1288.86	2002.13	2775.17	13'1"

Width	UP TO 460/15'1"			UP TO 480/15'9"			UP TO 500/16'5"			Width
	1	2	3	1	2	3	1	2	3	
Drop cm										Drop ft.ins.
60	658.80	770.65	891.88	685.83	802.52	929.01	712.83	834.42	966.17	2'0"
80	699.16	848.32	1009.95	727.94	883.59	1052.26	756.71	918.83	1094.53	2'7"
100	739.61	926.06	1128.08	770.14	964.70	1175.50	800.68	1003.32	1222.94	3'3"
120	780.03	1003.74	1246.14	812.28	1045.76	1298.70	844.58	1087.79	1351.27	3'11"
140	820.38	1081.39	1364.29	854.45	1126.80	1422.00	888.47	1172.18	1479.66	4'7"
160	860.80	1159.14	1482.39	896.66	1207.91	1545.19	932.45	1256.65	1608.03	5'3"
180	901.24	1236.77	1600.55	938.79	1288.93	1668.50	976.35	1341.07	1736.47	5'11"
200	941.65	1314.53	1718.62	980.97	1370.06	1791.75	1020.28	1425.59	1864.83	6'6"
220	982.04	1392.18	1836.57	1023.16	1451.07	1914.81	1064.21	1509.97	1992.95	7'3"
240	1022.47	1469.89	1954.74	1065.29	1532.18	2038.15	1108.13	1594.44	2121.47	7'10"
260	1062.92	1547.61	2072.88	1107.47	1613.27	2161.35	1152.10	1678.95	2249.87	8'6"
280	1103.32	1625.25	2191.01	1149.63	1694.30	2284.66	1195.99	1763.37	2378.29	9'2"
300	1143.68	1702.97	2309.08	1191.78	1775.34	2407.86	1239.89	1847.80	2506.65	9'10"
320	1184.05	1780.65	2427.17	1233.90	1856.45	2531.12	1283.77	1932.24	2634.99	10'6"
340	1224.47	1858.36	2545.31	1276.10	1937.53	2654.31	1327.69	2016.73	2763.37	11'2"
360	1264.94	1936.10	2663.45	1318.29	2018.62	2777.59	1371.67	2101.19	2891.78	11'10"
380	1305.30	2013.75	2781.52	1360.42	2099.71	2900.85	1415.52	2185.61	3020.16	12'6"
400	1345.74	2091.46	2899.57	1402.61	2180.76	3024.06	1459.52	2270.08	3148.49	13'1"

All prices shown exclude VAT



Vertical Blinds

System 2950

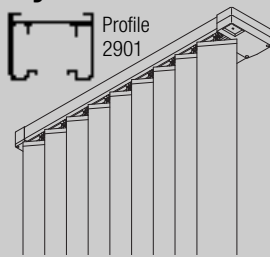

System 2950 Electrically Operated Vertical Blind System

Track system complete,
assembled, ready to hang.

Min. system width: 110cm
Max. system width: 600cm
Available in 127mm and 89mm systems.
Supplied with plug/socket 5741/5742 and
recess switch 0565 for open/close/tilt
operation. Silver or white at same cost.

	Price Ctgy.
Pricing for System 2950 Add to relevant hardware or hardware and fabric price over:	C
2950 £604.60	
2950R £803.34 (Integrated Receiver)	
System 0450 Radio Controls is also suitable for use with System 2950.	C

Accessories		Price Ctgy.
2901 Profile, silver or white. 9117 Set.		C
2912 Belt.		
2925 Belt connector.		
2927 Pilot runner.		
3033 Clamp.		
9091 Motor		

Bends	Max. trade discount	25%
Radius cm	Profile 2901	
50-99	£113.00	
Over 99	£215.50	

Colours	Price Ctgy.
Other colours special order – see page 1.	E

Pricing Examples	
2950 200cm width, straight hardware only:	
2900	+per system
£456.10	+£604.60
= £1060.70	
Note: Price based on 127mm/5" system.	

All prices shown
exclude VAT

System 2900

Profile 2901 available in 6
metre lengths only. Headrail
available in silver and white.

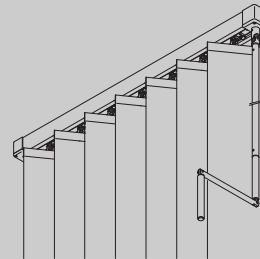
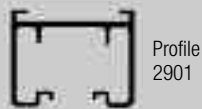

System 2900 Track and Accessories only

Track system only complete,
assembled, ready to hang.

Min. system width: 50cm
Max. system width: 600cm

Width up to cm/ft.ins.	£	Width up to cm/ft.ins.	£	Width up to cm/ft.ins.	£
120/3'11"	328.99	300/9'10"	614.91	480/15'9"	900.83
140/4'7"	360.76	320/10'6"	646.68	500/16'5"	932.56
160/5'3"	392.57	340/11'2"	678.43	520/17'0"	964.36
180/5'11"	424.33	360/11'10"	710.23	540/17'9"	996.09
200/6'6"	456.10	380/12'6"	741.98	560/18'5"	1027.91
220/7'3"	487.86	400/13'1"	773.75	580/19'0"	1059.68
240/7'10"	519.64	420/13'9"	805.54	600/19'8"	1091.43
260/8'6"	551.42	440/14'5"	837.29		
280/9'2"	583.13	460/15'1"	869.03		

Accessories		Price Ctgy.
2605 Top clip 127mm each, white.		C
2813 Top clip 89mm each, white.		
2735 Nylon weight hook, each, 100.		
2746 Detachable crank handle (standard).		
2824 Endstop, each, 10.		
2471 Bottom weight 127mm.		
2473 Bottom weight 89mm.		
2479 Bottom link cord 127mm.		
2481 Bottom link cord 89mm.		
2901 Profile, per metre.		
2912 Drive belt.		
2916 Rotation element 127 mm.		
2918 Rotation element 89mm.		
2920 Endpiece set, white or grey.		
2925 Belt Connector.		
2927 Pilot runner, each		
3033 Clamps set of 10, 100.		
2849 Top clip for PVC per 100.		
Metal wall brackets with rivetted clamps (fixed every 30cm plus 1 per length in silver, white or brown.		
Adjustable type		
3275/3044		
3276/3044		
3277/3044		
3239 Extension bracket, each.		
2962 Connecting bridge.		
6268 Hanger bracket for recess profile 2948.		
6952 Magnetic handle holder.		

Metal wall brackets with rivetted clamps (fixed every 30cm plus 1 per length in silver, white or brown.		Price Ctgy.
0686 Bottom weight 89mm/3 1/2" without horns.		A
0687 Bottom weight 127mm/5" without horns.		
1148C Screw 31mm/1 1/4" No. 8 counter sunk, 100.		

N.B.
For guidance the following
number of louvres per metre
should be calculated:
89mm/3 1/2" : 13/metre
127mm/5" : 10/metre

Fabric price categories

For system 2900 complete
with fabrics (see tables over)

Price Group 1
Element
Function

Price Group 2
Alutex
Colorama 2
Mercurio B
Multi Shadow
Multi Visio
Multiscreen 5%
Versascreen 1%
Versascreen 5%
Versascreen 10%

Price Group 3
Alutrans Pro
Moon
Reflex
Vertical Wave
Colorama 2 Bioactive

All fabrics are available in 89mm and
127mm louvres.

All above fabrics are FR



System 2900 complete with fabric

The prices below comprise complete system, silver or white ready-to-hang, top fix, single or pair stack with fabric choice in 127mm/5" louvres (see fabric price categories). Includes bottom weights and bottom link cord to both sides, 150cm drop operating crank handle. Wall fix brackets extra. For 89mm/3 1/2" louvres add 30%. If sizes lie between the measurements shown, the price for the next larger size will apply.

Price Category C

Width	UP TO 120/3'11"			UP TO 140/4'7"			UP TO 160/5'3"			Width
Drop cm	1	2	3	1	2	3	1	2	3	Drop ft.ins.
60	417.57	446.74	478.39	458.43	492.48	529.39	499.26	538.15	580.34	2'0"
80	428.14	467.00	509.18	470.72	516.09	565.35	513.32	565.16	621.41	2'7"
100	438.65	487.35	540.01	483.05	539.76	601.28	527.37	592.23	662.52	3'3"
120	449.22	507.55	570.76	495.32	563.38	637.19	541.42	619.26	703.59	3'11"
140	459.72	527.84	601.65	507.59	587.04	673.13	555.47	646.27	744.65	4'7"
160	470.28	548.10	632.43	519.90	610.71	709.06	569.54	673.28	785.69	5'3"
180	480.83	568.38	663.23	532.23	634.34	745.06	583.60	700.31	826.80	5'11"
200	491.38	588.66	694.07	544.51	658.02	780.97	597.64	727.32	867.85	6'6"
220	501.94	608.87	724.85	556.84	681.65	816.90	611.72	754.39	908.96	7'3"
240	512.47	629.14	755.69	569.08	705.26	852.87	625.78	781.40	950.05	7'10"
260	522.96	649.47	786.47	581.38	728.93	888.80	639.81	808.42	991.13	8'6"
280	533.53	669.73	817.32	593.69	752.56	924.72	653.85	835.44	1032.22	9'2"
300	544.10	690.01	848.12	605.98	776.22	960.69	667.88	862.45	1073.25	9'10"
320	554.63	710.24	878.91	618.30	799.88	996.62	681.96	889.46	1114.36	10'6"
340	565.14	730.52	909.74	630.60	823.49	1032.58	696.04	916.55	1155.43	11'2"
360	575.69	750.79	940.53	642.90	847.19	1068.52	710.07	943.55	1196.51	11'10"
380	586.25	771.03	971.34	655.19	870.78	1104.48	724.15	970.58	1237.63	12'6"
400	596.80	791.31	1002.14	667.49	894.46	1140.45	738.20	997.58	1278.65	13'1"

Width	UP TO 180/5'11"			UP TO 200/6'6"			UP TO 220/7'3"			Width
Drop cm	1	2	3	1	2	3	1	2	3	Drop ft.ins.
60	540.11	583.88	631.29	580.97	629.56	682.28	621.77	675.29	733.24	2'0"
80	555.89	614.28	677.49	598.51	663.35	733.69	641.11	712.46	789.71	2'7"
100	571.69	644.68	723.73	616.04	697.12	784.95	660.42	749.59	846.22	3'3"
120	587.54	675.04	769.93	633.63	730.91	836.33	679.76	786.73	902.72	3'11"
140	603.35	705.48	816.18	651.21	764.67	887.68	699.08	823.93	959.19	4'7"
160	619.14	735.86	862.37	668.79	798.49	939.03	718.37	861.06	1015.64	5'3"
180	634.96	766.29	908.60	686.35	832.26	990.36	737.74	898.24	1072.13	5'11"
200	650.78	796.68	954.79	703.94	866.02	1041.74	757.02	935.38	1128.63	6'6"
220	666.61	827.08	1001.00	721.50	899.83	1093.08	776.38	972.55	1185.10	7'3"
240	682.40	857.50	1047.25	739.06	933.59	1144.42	795.70	1009.70	1241.58	7'10"
260	698.22	887.88	1093.42	756.62	967.40	1195.75	815.05	1046.85	1298.11	8'6"
280	713.99	918.28	1139.68	774.19	1001.16	1247.11	834.37	1084.01	1354.55	9'2"
300	729.86	948.69	1185.88	791.75	1034.93	1298.45	853.67	1121.14	1411.07	9'10"
320	745.66	979.12	1232.10	809.33	1068.73	1349.80	873.02	1158.29	1467.56	10'6"
340	761.46	1009.52	1278.27	826.88	1102.50	1401.15	892.33	1195.48	1524.03	11'2"
360	777.28	1039.93	1324.51	844.48	1136.27	1452.51	911.67	1232.64	1580.49	11'10"
380	793.11	1070.30	1370.72	862.06	1170.05	1503.84	930.99	1269.77	1636.98	12'6"
400	808.85	1100.69	1416.96	879.61	1203.82	1555.20	950.28	1306.95	1693.47	13'1"

Width	UP TO 240/7'10"			UP TO 260/8'6"			UP TO 280/9'2"			Width
Drop cm	1	2	3	1	2	3	1	2	3	Drop ft.ins.
60	662.61	720.99	784.24	703.45	766.66	835.18	744.30	812.37	886.17	2'0"
80	683.69	761.48	845.86	726.28	810.58	901.93	768.86	859.63	958.03	2'7"
100	704.79	802.04	907.44	749.12	854.48	968.70	793.48	906.97	1029.95	3'3"
120	725.87	842.59	969.05	771.96	898.40	1035.47	818.09	954.26	1101.84	3'11"
140	746.89	883.11	1030.70	794.81	942.34	1102.21	842.68	1001.55	1173.72	4'7"
160	768.02	923.62	1092.32	817.63	986.26	1168.98	867.26	1048.83	1245.60	5'3"
180	789.11	964.20	1153.92	840.49	1030.16	1235.70	891.84	1096.14	1317.51	5'11"
200	810.19	1004.73	1215.59	863.33	1074.05	1302.46	916.47	1143.43	1389.37	6'6"
220	831.28	1045.26	1277.13	886.17	1117.98	1369.26	941.09	1190.68	1461.29	7'3"
240	852.31	1085.76	1338.75	908.99	1161.90	1435.95	965.67	1238.00	1533.14	7'10"
260	873.42	1126.35	1400.40	931.83	1205.82	1502.77	990.25	1285.31	1605.05	8'6"
280	894.53	1166.86	1462.00	954.69	1249.74	1569.47	1014.83	1332.54	1676.96	9'2"
300	915.59	1207.44	1523.66	977.50	1293.64	1636.21	1039.42	1379.88	1748.81	9'10"
320	936.70	1247.93	1585.27	1000.35	1337.54	1702.99	1064.05	1427.18	1820.73	10'6"
340	957.74	1288.48	1646.88	1023.21	1381.49	1769.72	1088.65	1474.49	1892.56	11'2"
360	978.86	1329.01	1708.47	1046.05	1425.40	1836.49	1113.24	1521.75	1964.49	11'10"
380	999.91	1369.58	1770.08	1068.84	1469.32	1903.22	1137.82	1569.03	2036.37	12'6"
400	1020.99	1410.10	1831.73	1091.71	1513.20	1969.96	1162.40	1616.33	2108.25	13'1"

All prices shown exclude VAT



System 2900 complete with fabric

The prices below comprise complete system, silver or white ready-to-hang, top fix, single or pair stack with fabric choice in 127mm/5" louvres (see fabric price categories). Includes bottom weights and bottom link cord to both sides, 150cm drop operating crank handle. Wall fix brackets extra. For 89mm/3½" louvres add 30%. If sizes lie between the measurements shown, the price for the next larger size will apply.

Price Category C

Width	UP TO 300/9'10"			UP TO 320/10'6"			UP TO 340/11'2"			Width
Drop cm	1	2	3	1	2	3	1	2	3	Drop ft.ins.
60	785.14	858.07	937.11	825.95	903.75	988.12	866.82	949.46	1039.08	2'0"
80	811.45	908.77	1014.16	854.07	957.81	1070.24	896.67	1006.87	1126.40	2'7"
100	837.82	959.43	1091.18	882.17	1011.87	1152.44	926.56	1064.34	1213.67	3'3"
120	864.16	1010.10	1168.18	910.30	1065.91	1234.59	956.41	1121.73	1300.96	3'11"
140	890.51	1060.79	1245.26	938.40	1119.95	1316.76	986.27	1179.21	1388.22	4'7"
160	916.89	1111.43	1322.25	966.50	1174.00	1398.86	1016.13	1236.61	1475.51	5'3"
180	943.24	1162.09	1399.29	994.63	1228.08	1481.03	1045.99	1294.04	1562.83	5'11"
200	969.58	1212.76	1476.28	1022.76	1282.10	1563.21	1075.86	1351.48	1650.12	6'6"
220	995.93	1263.43	1553.30	1050.85	1336.17	1645.38	1105.75	1408.88	1737.43	7'3"
240	1022.30	1314.08	1630.36	1078.96	1390.21	1727.53	1135.60	1466.30	1824.71	7'10"
260	1048.64	1364.75	1707.37	1107.02	1444.24	1809.68	1165.46	1523.74	1912.02	8'6"
280	1075.01	1415.46	1784.40	1135.17	1498.32	1891.83	1195.35	1581.14	1999.32	9'2"
300	1101.36	1466.12	1861.42	1163.28	1552.37	1974.02	1225.22	1638.62	2086.59	9'10"
320	1127.74	1516.78	1938.41	1191.40	1606.42	2056.13	1255.06	1696.01	2173.87	10'6"
340	1154.06	1567.46	2015.44	1219.51	1660.44	2138.30	1284.89	1753.42	2261.16	11'2"
360	1180.44	1618.12	2092.48	1247.59	1714.52	2220.46	1314.80	1810.89	2348.45	11'10"
380	1206.76	1668.80	2169.49	1275.72	1768.55	2302.64	1344.65	1868.29	2435.74	12'6"
400	1233.14	1719.45	2246.50	1303.83	1822.63	2384.82	1374.54	1925.72	2523.04	13'1"

Width	UP TO 360/11'10"			UP TO 380/12'6"			UP TO 400/13'1"			Width
Drop cm	1	2	3	1	2	3	1	2	3	Drop ft.ins.
60	907.63	995.16	1090.04	948.49	1040.89	1141.03	989.29	1086.58	1192.01	2'0"
80	939.26	1056.00	1182.48	981.87	1105.05	1238.56	1024.44	1154.14	1294.69	2'7"
100	970.89	1116.80	1274.89	1015.25	1169.25	1336.16	1059.55	1221.71	1397.39	3'3"
120	1002.49	1177.59	1367.36	1048.62	1233.41	1433.71	1094.71	1289.25	1500.08	3'11"
140	1034.16	1238.41	1459.78	1082.02	1297.61	1531.24	1129.87	1356.79	1602.76	4'7"
160	1065.75	1299.22	1552.18	1115.38	1361.77	1628.80	1165.02	1424.39	1705.49	5'3"
180	1097.36	1359.99	1644.61	1148.74	1425.98	1726.40	1200.13	1491.93	1808.18	5'11"
200	1128.96	1420.80	1737.02	1182.14	1490.15	1823.94	1235.29	1559.50	1910.88	6'6"
220	1160.65	1481.59	1829.46	1215.53	1554.36	1921.53	1270.40	1627.07	2013.57	7'3"
240	1192.23	1542.45	1921.92	1248.89	1618.53	2019.04	1305.55	1694.62	2116.24	7'10"
260	1223.87	1603.22	2014.33	1282.30	1682.69	2116.66	1340.68	1762.18	2218.97	8'6"
280	1255.49	1664.01	2106.73	1315.65	1746.89	2214.24	1375.83	1829.71	2321.65	9'2"
300	1287.12	1724.81	2199.19	1349.04	1811.05	2311.76	1410.96	1897.29	2424.31	9'10"
320	1318.74	1785.65	2291.64	1382.41	1875.23	2409.37	1446.10	1964.88	2527.06	10'6"
340	1350.38	1846.46	2384.03	1415.81	1939.42	2506.89	1481.23	2032.43	2629.74	11'2"
360	1381.97	1907.24	2476.48	1449.18	2003.63	2604.44	1516.37	2099.96	2732.46	11'10"
380	1413.61	1968.05	2568.86	1482.53	2067.77	2701.99	1551.48	2167.51	2835.17	12'6"
400	1445.25	2028.84	2661.32	1515.94	2131.98	2799.57	1586.62	2235.08	2937.88	13'1"

Width	UP TO 420/13'9"			UP TO 440/ 14'5"			UP TO 460/15'1"			Width
Drop cm	1	2	3	1	2	3	1	2	3	Drop ft.ins.
60	1030.15	1132.27	1242.97	1071.02	1177.99	1293.91	1111.81	1223.65	1344.91	2'0"
80	1067.03	1203.22	1350.81	1109.65	1252.28	1406.92	1152.24	1301.41	1462.98	2'7"
100	1103.93	1274.14	1458.63	1148.29	1326.60	1519.90	1192.60	1379.09	1581.10	3'3"
120	1140.84	1345.12	1566.49	1186.98	1400.90	1632.84	1233.02	1456.78	1699.23	3'11"
140	1177.72	1416.02	1674.31	1225.59	1475.25	1745.83	1273.48	1534.46	1817.30	4'7"
160	1214.62	1486.95	1782.12	1264.25	1549.56	1858.78	1313.87	1612.15	1935.43	5'3"
180	1251.52	1557.91	1889.94	1302.88	1623.88	1971.77	1354.29	1689.86	2053.52	5'11"
200	1288.40	1628.81	1997.78	1341.55	1698.20	2084.70	1394.68	1767.55	2171.62	6'6"
220	1325.33	1699.80	2105.62	1380.23	1772.51	2197.68	1435.08	1845.27	2289.74	7'3"
240	1362.19	1770.70	2213.45	1418.84	1846.82	2310.63	1475.49	1922.90	2407.83	7'10"
260	1399.10	1841.69	2321.25	1457.51	1921.13	2423.60	1515.90	2000.62	2525.92	8'6"
280	1435.97	1912.60	2429.10	1496.14	1995.45	2536.59	1556.31	2078.31	2644.02	9'2"
300	1472.88	1983.55	2536.97	1534.80	2069.77	2649.56	1596.74	2156.02	2762.11	9'10"
320	1509.78	2054.48	2644.77	1573.45	2144.07	2762.50	1637.11	2233.73	2880.24	10'6"
340	1546.64	2125.41	2752.63	1612.08	2218.37	2875.45	1677.55	2311.41	2998.34	11'2"
360	1583.52	2196.31	2860.44	1650.74	2292.73	2988.44	1717.92	2389.06	3116.45	11'10"
380	1620.47	2267.28	2968.30	1689.40	2367.03	3101.43	1758.32	2466.82	3234.54	12'6"
400	1657.36	2338.24	3076.14	1728.04	2441.37	3214.38	1798.76	2544.46	3352.66	13'1"

All prices shown exclude VAT



System 2900 complete with fabric

The prices below comprise complete system, silver or white ready-to-hang, top fix, single or pair stack with fabric choice in 127mm/5" louvres (see fabric price categories). Includes bottom weights and bottom link cord to both sides, 150cm drop operating crank handle. Wall fix brackets extra. For 89mm/3 1/2" louvres add 30%. If sizes lie between the measurements shown, the price for the next larger size will apply.

Price Category C

Width	UP TO 480/15'9"			UP TO 500/16'5"			UP TO 520/17'0"			Width
Drop cm	1	2	3	1	2	3	1	2	3	Drop ft.ins.
60	1152.68	1269.42	1395.91	1193.46	1315.08	1446.87	1234.30	1360.78	1497.78	2'0"
80	1194.84	1350.44	1519.13	1237.40	1399.49	1575.21	1280.05	1448.63	1631.33	2'7"
100	1237.00	1431.55	1642.32	1281.32	1483.99	1703.59	1325.68	1536.44	1764.84	3'3"
120	1279.14	1512.61	1765.61	1325.29	1568.42	1831.97	1371.39	1624.26	1898.36	3'11"
140	1321.33	1593.68	1888.82	1369.18	1652.89	1960.36	1417.05	1712.13	2031.87	4'7"
160	1363.50	1674.75	2012.04	1413.09	1737.36	2088.69	1462.73	1799.91	2165.39	5'3"
180	1405.63	1755.81	2135.31	1457.01	1821.80	2217.06	1508.41	1887.77	2298.87	5'11"
200	1447.81	1836.84	2258.53	1500.92	1906.25	2345.42	1554.08	1975.59	2432.38	6'6"
220	1489.98	1917.96	2381.79	1544.91	1990.68	2473.82	1599.77	2063.41	2565.85	7'3"
240	1532.14	1999.03	2505.01	1588.82	2075.17	2602.19	1645.44	2151.24	2699.38	7'10"
260	1574.33	2080.11	2628.25	1632.70	2159.56	2730.56	1691.11	2239.08	2832.88	8'6"
280	1616.45	2161.17	2751.48	1676.62	2244.03	2858.92	1736.82	2326.92	2966.37	9'2"
300	1658.64	2242.24	2874.72	1720.56	2328.49	2987.30	1782.48	2414.72	3099.87	9'10"
320	1700.83	2323.33	2997.98	1764.49	2412.93	3115.73	1828.16	2502.55	3233.42	10'6"
340	1742.98	2404.39	3121.17	1808.41	2497.37	3244.05	1873.84	2590.39	3366.89	11'2"
360	1785.15	2485.49	3244.46	1852.32	2581.86	3372.42	1919.52	2678.22	3500.39	11'10"
380	1827.31	2566.53	3367.69	1896.23	2666.28	3500.77	1965.21	2766.05	3633.89	12'6"
400	1869.45	2647.60	3490.92	1940.14	2750.77	3629.19	2010.87	2853.87	3767.44	13'1"

Width	UP TO 540/17'9"			UP TO 560/18'5"			UP TO 580/19'3"			Width
Drop cm	1	2	3	1	2	3	1	2	3	Drop ft.ins.
60	1275.16	1406.50	1548.80	1315.99	1452.18	1599.77	1356.86	1497.90	1650.72	2'0"
80	1322.60	1497.70	1687.46	1365.21	1546.79	1743.53	1407.77	1595.86	1799.67	2'7"
100	1370.05	1588.91	1826.09	1414.41	1641.38	1887.31	1458.77	1693.78	1948.53	3'3"
120	1417.51	1680.08	1964.70	1463.58	1735.91	2031.07	1509.70	1791.80	2097.48	3'11"
140	1464.90	1771.30	2103.35	1512.79	1830.53	2174.89	1560.66	1889.73	2246.37	4'7"
160	1512.35	1862.53	2242.01	1561.98	1925.11	2318.64	1611.61	1987.69	2395.28	5'3"
180	1559.78	1953.72	2380.66	1611.15	2019.71	2462.42	1662.50	2085.68	2544.22	5'11"
200	1607.25	2044.95	2519.29	1660.34	2114.25	2606.18	1713.48	2183.61	2693.06	6'6"
220	1654.64	2136.16	2657.90	1709.55	2208.85	2750.02	1764.47	2281.60	2842.03	7'3"
240	1702.09	2227.34	2796.57	1758.73	2303.46	2893.75	1815.40	2379.56	2990.90	7'10"
260	1749.53	2318.56	2935.18	1807.94	2398.03	3037.52	1866.35	2477.52	3139.86	8'6"
280	1796.97	2409.75	3073.85	1857.15	2492.65	3181.29	1917.28	2575.47	3288.79	9'2"
300	1844.39	2500.97	3212.53	1906.30	2587.13	3325.11	1968.21	2673.45	3437.67	9'10"
320	1891.83	2592.16	3351.11	1955.55	2681.81	3468.85	2019.20	2771.38	3586.62	10'6"
340	1939.26	2683.37	3489.78	2004.69	2776.35	3612.63	2070.15	2869.35	3735.50	11'2"
360	1986.71	2774.59	3628.40	2053.91	2870.95	3756.40	2121.10	2967.33	3884.41	11'10"
380	2034.11	2865.79	3767.06	2103.06	2965.53	3900.20	2172.04	3065.27	4033.32	12'6"
400	2081.55	2957.02	3905.72	2152.27	3060.11	4043.94	2222.96	3163.23	4182.25	13'1"

Width	UP TO 600/19'4"			Width
Drop cm	1	2	3	Drop ft.ins.
60	1397.66	1543.60	1701.68	2'0"
80	1450.36	1644.93	1855.75	2'7"
100	1503.10	1746.30	2009.82	3'3"
120	1555.78	1847.60	2163.87	3'11"
140	1608.51	1948.97	2317.91	4'7"
160	1661.24	2050.31	2471.94	5'3"
180	1713.97	2151.66	2625.95	5'11"
200	1766.67	2252.99	2780.04	6'6"
220	1819.37	2354.30	2934.09	7'3"
240	1872.07	2455.66	3088.14	7'10"
260	1924.78	2557.00	3242.16	8'6"
280	1977.48	2658.33	3396.24	9'2"
300	2030.16	2759.69	3550.25	9'10"
320	2082.89	2861.00	3704.28	10'6"
340	2135.59	2962.34	3858.37	11'2"
360	2188.28	3063.72	4012.40	11'10"
380	2240.96	3165.05	4166.44	12'6"
400	2293.67	3266.39	4320.48	13'1"

All prices shown exclude VAT



Roller Blinds

System 4900

Spring operation with decelerator and continuous headrail as standard.
Tube diameter 41mm

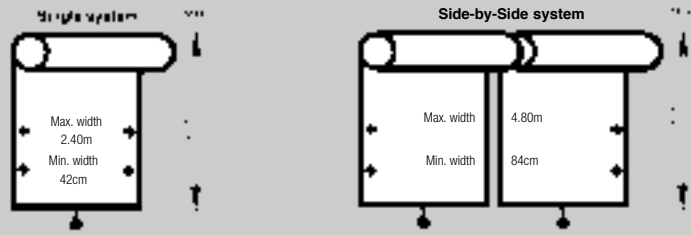

System 4900 complete with fabric

The prices below comprise the complete system made-to-measure, ready-to-hang with fabric of your choice. Operation as standard with pull-ball. Please consult application chart (page 53) to ensure that fabric chosen can be supplied in dimensions required.

Price category C

Price Group 1R

Colorama 1
Colorama 1 Alu
Element

Width	60cm	80cm	100cm	120cm	140cm	160cm	180cm	200cm	220cm	240cm	Width
Drop											Drop
60	232.81	245.61	258.44	271.24	284.03	296.85	309.65	322.44	397.60	411.46	2'0"
80	236.80	250.91	265.03	279.15	293.30	307.35	321.47	335.60	412.08	427.27	2'7"
100	240.70	256.17	271.57	287.06	302.47	317.87	333.32	348.78	426.55	443.06	3'3"
120	244.67	261.46	278.20	294.93	311.68	328.45	345.17	361.92	441.05	458.90	3'11"
140	248.63	266.70	284.76	302.82	320.89	338.97	357.03	375.11	455.56	474.67	4'7"
160	252.59	271.96	291.36	310.74	330.08	349.50	368.88	388.27	470.04	490.47	5'3"
180	256.51	277.25	297.91	318.64	339.34	360.02	380.73	401.45	484.49	506.27	5'11"
200	260.48	282.51	304.53	326.52	348.54	370.57	392.58	414.58	498.97	522.07	6'6"
220	264.43	287.73	311.07	334.44	357.75	381.13	404.45	427.75	513.49	537.89	7'3"
240	268.38	293.01	317.69	342.34	367.01	391.62	416.26	440.95	527.93	553.63	7'10"
260	272.33	298.27	324.27	350.20	376.21	402.17	428.14	454.10	542.40	569.45	8'6"
280	276.27	303.56	330.86	358.13	385.40	412.70	439.96	467.29	556.91	585.25	9'2"
300	280.20	308.84	337.39	366.03	394.65	423.22	451.82	480.43	571.40	601.03	9'10"

Price Group 2R

Alutex
Alutrans Pro
Colorama 2
Colorama 2 Alu
Colorama 2 Bioactive
Mercurio B
Multi Shadow
Multi Visio
Multiscreen 10%

Width	60cm	80cm	100cm	120cm	140cm	160cm	180cm	200cm	220cm	240cm	Width
Drop											Drop
60	240.35	255.69	270.94	286.28	301.60	316.90	332.20	347.52	425.15	441.53	2'0"
80	246.82	264.28	281.69	299.18	316.66	334.11	351.58	369.04	448.84	467.41	2'7"
100	253.27	272.87	292.47	312.12	331.72	351.31	370.91	390.57	472.51	493.23	3'3"
120	259.72	281.50	303.23	324.99	346.78	368.53	390.30	412.06	496.20	519.06	3'11"
140	266.19	290.09	314.06	337.92	361.86	385.75	409.62	433.58	519.84	544.83	4'7"
160	272.63	298.67	324.75	350.83	376.90	402.95	429.05	455.12	543.52	570.66	5'3"
180	279.06	307.29	335.51	363.73	391.99	420.19	448.41	476.64	567.21	596.48	5'11"
200	285.54	315.88	346.26	376.62	406.97	437.45	467.78	498.14	590.85	622.30	6'6"
220	291.99	324.50	357.04	389.58	422.10	454.61	487.10	519.68	614.55	648.13	7'3"
240	298.49	333.11	367.77	402.47	437.17	471.82	506.49	541.19	638.24	673.97	7'10"
260	304.87	341.75	378.54	415.38	452.24	489.04	525.87	562.71	661.91	699.78	8'6"
280	311.38	350.38	389.32	428.27	467.30	506.27	545.27	584.22	685.55	725.61	9'2"
300	317.81	358.93	400.07	441.18	482.36	523.46	564.59	605.76	709.23	751.43	9'10"

Price Group 3R

Aluscreen Futura
Deep
Ecoscreen
Lightscreen
Linea
Linea Alu
Mica
Moon
Newlife 1
Newlife 2
Reflex
Safescreen
Sevena
Treviscreen

Width	60cm	80cm	100cm	120cm	140cm	160cm	180cm	200cm	220cm	240cm	Width
Drop											Drop
60	256.58	277.29	298.07	318.73	339.48	360.22	380.90	401.65	484.73	506.51	2'0"
80	268.46	293.18	317.81	342.53	367.17	391.86	416.58	441.21	528.26	554.04	2'7"
100	280.35	308.99	337.60	366.27	394.88	423.53	452.18	480.80	571.81	601.45	3'3"
120	292.20	324.77	357.41	390.01	422.58	455.16	487.78	520.35	615.34	649.00	3'11"
140	304.08	340.63	377.16	413.72	450.29	486.86	523.37	559.93	658.87	696.44	4'7"
160	315.93	356.46	396.99	437.50	478.02	518.50	558.99	599.49	702.39	743.96	5'3"
180	327.84	372.29	416.74	461.20	505.66	550.16	594.62	639.06	745.91	791.46	5'11"
200	339.72	388.12	436.58	484.95	533.41	581.80	630.21	678.67	789.43	838.89	6'6"
220	351.58	403.95	456.32	508.71	561.07	613.47	665.86	718.23	832.99	886.44	7'3"
240	363.44	419.81	476.13	532.42	588.75	645.11	701.46	757.79	876.47	933.86	7'10"
260	375.31	435.59	495.89	556.18	616.48	676.77	737.10	797.37	920.03	981.38	8'6"
280	387.20	451.44	515.69	579.96	644.18	708.43	772.66	836.95	963.58	1028.91	9'2"
300	399.03	467.29	535.45	603.68	671.90	740.09	808.31	876.50	1007.10	1076.35	9'10"

System 4900 – Side-by-Side System

Simply price as two separate systems stating side-by-side.

Spring Clutch	Width of blind up to									
	60cm	80cm	100cm	120cm	140cm	160cm	180cm	200cm	220cm	240cm
10562 A	177.37	180.91	184.47	188.01	191.54	195.10	198.64	202.22	205.80	209.39
10563 B	179.51	183.04	186.62	190.15	193.68	197.27	200.77	204.29	207.81	211.34
10564 C	188.01	191.54	195.08	198.61	202.20	205.74	209.28	212.82	216.36	219.91
10565 D	197.32	200.93	204.55	208.17	211.75	215.40	219.02	222.59	226.18	229.75
10566 E	219.60	223.17	226.79	230.42	234.04	237.68	241.25	244.88	248.53	252.16
10567 F	223.49	227.04	230.60	234.13	237.70	241.23	244.77	248.31	251.86	255.40

System 4900 – Hardware only

Supplied ready-assembled incl. adhesive tape for customers to mount own fabrics. Bottom bar not incl. – see page 53.

Side-guide wire option is available at an additional cost of £40.00.

For optional stop controller add £42.59.

All prices shown exclude VAT



Roller Blinds

Laminated Blinds (Customer's own material for Roller Blinds)

Supply your own fabric, we will provide the laminating service. Prices below include for hardware systems 4900/4910. Sewn-in bottom bar supplied as standard (Trim 16). For decorative trims choose from table below. All blinds supplied forward roll as standard; please specify if reverse roll is required. Our laminate will usually be supplied in cream as standard.

Price category C

Width	System	100	120	140	160	170	180	200	220	230	Width
Drop cm		3'3"	3'11"	4'7"	5'3"	5'7"	5'11"	6'6"	7'3"	7'5"	Drop ft.ins.
90		303.26	327.14	351.10	374.96	398.84	641.98	652.14	702.02	714.39	2'11"
120		337.13	367.77	398.54	429.20	459.82	669.79	694.06	735.12	771.76	3'11"
150	4900/	371.03	408.43	446.05	483.41	520.81	734.66	773.50	812.35	906.37	4'11"
180	4910/	404.91	449.08	493.48	537.63	581.80	778.79	870.60	909.45	992.43	5'11"
210	(4960 electric)	438.76	489.76	540.91	591.87	642.82	873.68				7'0"
240		472.59	530.28	588.21	645.91	703.61	922.22				7'10"
270		588.51	654.04	719.89	785.42	850.93	1021.52				8'10"
300		622.36	694.70	768.99	842.88	918.88					9'10"

Prices in this table are for spring or chain operation. For electric (4960) add £466.28.

Flame Retardant (FR) Laminate

Add 20% to prices shown above. FR laminate available in white or cream.

Blackout Laminate

Add 20% to prices shown above. Blackout laminate available in white or cream.

Decorative Trims

All shapes come with matching braid unless otherwise specified. Add price for trim to prices above.

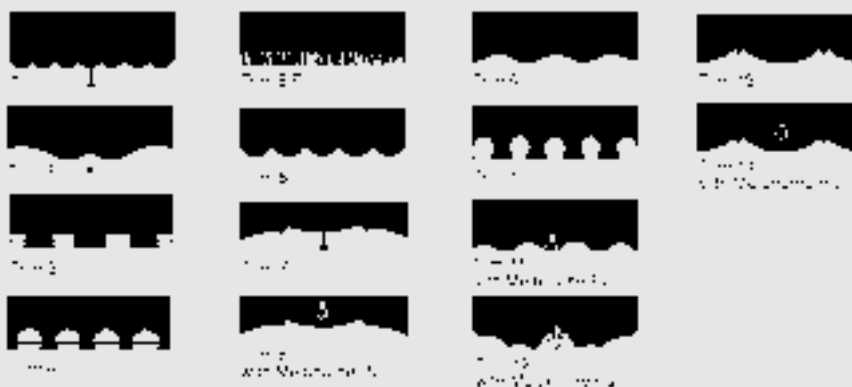

Alternative Trims

Price category C

Width	cm	80	100	120	140	160	170
Trims 1, 2, 5, 6, 7, 9 & 13		£29.79	32.01	44.66	52.06	59.48	63.21
Trims 3, 4 & 10		£43.70	54.68	65.62	76.53	87.47	92.96
Trims 8, 11, 12, 14		£64.50	80.60	96.67	112.77	128.85	136.89

Piping

Piping for Trims 1, 2, 5, 6: add 20% to prices above and send fabric for piping.

All prices shown exclude VAT



Roller Blinds

System 4910

Chain operated roller blinds.
Tube diameter 41mm

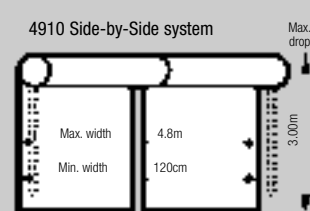
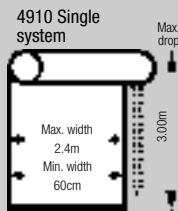

System 4910 complete with fabric

The prices below comprise the complete system made-to-measure, ready-to-hang with fabric of your choice. Please consult application chart (page 53) to ensure that fabric desired can be supplied in dimensions required.

Price category C

Price Group 1R

Colorama 1
Colorama 1 Alu
Element
Puma

Width	60cm	80cm	100cm	120cm	140cm	160cm	180cm	200cm	220cm	240cm	Width
Drop cm											Drop
60	203.40	215.09	226.79	238.51	250.17	261.92	273.57	285.27	296.97	308.67	2'0"
80	207.44	220.48	233.53	246.51	259.57	272.61	285.67	298.66	311.72	324.79	2'7"
100	211.44	225.84	240.20	254.62	268.95	283.34	297.73	312.13	324.85	337.57	3'3"
120	215.47	231.20	246.91	262.66	278.33	294.11	309.80	325.54	341.25	356.96	3'11"
140	219.49	236.55	253.62	270.69	287.73	304.81	321.85	338.94	355.99	373.02	4'7"
160	223.50	241.91	260.31	278.75	297.14	315.52	333.96	352.36	370.80	389.23	5'3"
180	227.52	247.31	267.06	286.78	306.54	326.29	346.05	365.72	385.46	405.19	5'11"
200	231.63	252.63	273.75	294.84	315.88	337.02	358.08	379.18	400.25	421.30	6'6"
220	235.60	258.06	280.48	302.85	325.28	347.73	370.17	392.59	415.05	437.49	7'3"
240	239.63	263.41	287.15	310.95	334.69	358.48	382.24	406.00	429.75	453.50	7'10"
260	243.63	268.77	293.87	318.98	344.12	369.19	394.34	419.48	444.56	469.64	8'6"
280	247.68	274.12	300.57	326.98	353.52	379.92	406.38	432.82	459.25	485.67	9'2"
300	251.69	279.52	307.26	335.04	362.89	390.66	418.47	446.24	474.04	501.85	9'10"

Price Group 2R

Alutex **Triscreen 1%**
Alutrans Pro **Triscreen 3%**
Colorama 2 **Triscreen 5%**
Colorama 2 Alu **Versascreen 1%**
Colorama 2 Bioactive **Versascreen 5%**
Mercurio B **Versascreen 10%**
Multi Shadow
Multi Visio
Multiscreen 1%
Multiscreen 5%
Multiscreen 10%

Width	60cm	80cm	100cm	120cm	140cm	160cm	180cm	200cm	220cm	240cm	Width
Drop cm											Drop
60	211.08	225.32	239.54	253.81	268.08	282.30	296.56	310.79	325.00	339.20	2'0"
80	217.62	234.08	250.52	266.98	283.40	299.81	316.27	332.71	349.15	365.60	2'7"
100	224.22	242.84	261.49	280.09	298.70	317.37	336.00	354.62	373.23	391.85	3'3"
120	230.79	251.62	272.45	293.30	314.11	334.90	355.72	376.56	397.42	418.27	3'11"
140	237.38	260.38	283.40	306.41	329.44	352.47	375.47	398.46	421.48	444.50	4'7"
160	243.96	269.16	294.33	319.57	344.79	369.99	395.16	420.39	445.59	470.78	5'3"
180	250.52	277.87	305.29	332.71	360.16	387.54	414.91	442.31	469.72	497.14	5'11"
200	257.08	286.66	316.27	345.85	375.47	405.03	434.63	464.25	493.82	523.40	6'6"
220	263.66	295.42	327.21	359.01	390.81	422.58	454.35	486.17	517.94	549.69	7'3"
240	270.25	304.19	338.22	372.16	406.16	440.11	474.11	508.11	542.06	576.01	7'10"
260	276.85	313.00	349.15	385.33	421.48	457.64	493.81	529.96	566.16	602.37	8'6"
280	283.40	321.77	360.16	398.46	436.80	475.19	513.53	551.90	590.23	628.56	9'2"
300	289.99	330.51	371.08	411.63	452.18	492.70	533.27	573.84	614.37	654.92	9'10"

Price Group 3R

Aluscreen Futura
Deep
Ecoscreen
Jumbotex
Lightscreen
Linea
Linea Alu
Mica
Moon
Newlife 1
Newlife 2
Reflex
Safescreen
Sevena
Treviscreen

Width	60cm	80cm	100cm	120cm	140cm	160cm	180cm	200cm	220cm	240cm	Width
Drop cm											Drop
60	227.61	247.41	267.12	286.90	306.66	326.46	346.18	365.99	385.72	397.29	2'0"
80	239.72	263.50	287.30	311.12	334.94	358.70	382.54	406.29	430.11	443.01	2'7"
100	251.79	279.65	307.50	335.33	363.12	390.95	418.82	446.62	474.48	488.71	3'3"
120	263.93	295.77	327.62	359.50	391.34	423.21	455.11	486.94	518.80	534.36	3'11"
140	276.02	311.87	347.79	383.70	419.59	455.50	491.36	527.25	563.15	580.04	4'7"
160	288.08	328.01	367.99	407.85	447.79	487.71	527.68	567.58	607.48	625.70	5'3"
180	300.18	344.15	388.12	432.05	476.02	519.99	563.91	607.90	651.83	671.38	5'11"
200	312.29	360.26	408.25	456.26	504.24	552.21	600.20	648.23	696.22	717.11	6'6"
220	324.36	376.40	428.45	480.45	532.44	584.49	636.52	688.52	740.57	762.79	7'3"
240	336.50	392.53	448.60	504.62	560.65	616.71	672.78	728.86	784.94	808.49	7'10"
260	348.55	408.63	468.71	528.83	588.90	649.01	709.06	769.14	829.23	854.11	8'6"
280	360.66	424.78	488.89	553.03	617.10	681.24	745.38	809.47	873.55	899.76	9'2"
300	372.73	440.91	509.07	577.20	645.35	713.54	781.66	849.79	917.92	945.46	9'10"

System 4910 – Side-by-Side System

There is no add-on. Simply order two systems, stating side-by-side.

System 4910 – Hardware only

Supplied ready-assembled incl. adhesive tape for customers to mount own fabrics. Standard chain drop 1.50m. Bottom bar is not included – see page 53.

Side-guide wire option is available at an additional cost of £40.00.

Spring Clutch Set	Width of blind up to									
	60cm	80cm	100cm	120cm	140cm	160cm	180cm	200cm	220cm	240cm
10545/46/51/52	164.41	167.41	170.44	173.47	176.49	179.51	182.53	185.54	188.56	190.09
10547/48/53/54	190.27	193.43	196.58	199.73	202.83	209.11	212.27	215.38	216.92	223.44
10549/55/10697/98/99/10700	195.67	198.76	201.88	205.01	208.08	211.20	214.31	217.43	220.53	223.63

All prices shown exclude VAT



Roller Blinds

System 4830

Heavy duty chain operated
Roller Blind system.
Tube diameter 55mm.

Max. surface area 10m²

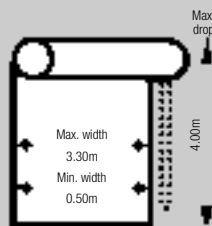

System 4830 complete with fabric

The prices below comprise the complete system made-to-measure, ready to hang with fabric of your choice. Please be aware that due to the size capabilities of this system, larger sizes can only be achieved by welding the fabric. Fabrics that can be welded are indicated below in bold print.

Price Category C

Price Group 1R

Colorama 1
Colorama 1 Alu
Element
Puma

Width ► Drop ▼	100cm 3'3"	125cm 4'1"	150cm 4'11"	175cm 5'8"	200cm 6'6"	225cm 7'4"	250cm 8'2"	275cm 9'0"	300cm 9'10"	330cm 10'10"	◀ Width ▼ Drop
50cm	278.40	303.40	328.21	353.89	378.01	410.66	428.60	452.73	477.66	507.52	1'8"
100cm	294.86	324.27	353.36	382.47	411.55	440.68	469.76	498.82	527.93	562.86	3'3"
150cm	311.95	345.23	378.51	411.78	445.09	478.37	511.66	544.95	578.21	618.18	4'11"
200cm	328.71	366.18	403.65	441.12	478.60	516.07	553.56	591.03	628.52	673.49	6'6"
250cm	345.46	387.13	428.81	470.47	512.15	553.81	595.47	637.15	678.82	728.81	8'2"
300cm	362.24	408.09	453.97	499.81	545.64	591.52	637.38	683.25	729.12	784.14	9'10"
350cm	379.00	429.04	479.10	529.15	579.18	629.25	679.31	729.34	779.41		11'6"
400cm	395.78	450.02	504.24	558.48	612.71	666.97	721.25	775.46		Max. 10m ²	13'1"

Price Group 2R

Alutex
Alutrans Pro
Colorama 2
Colorama 2 Alu
Colorama 2 Bioactive
Mercurio B
Multi Shadow
Multi Visio
Multiscreen 1%
Multiscreen 5%
Multiscreen 10%

Triscreen 1%
Triscreen 3%
Triscreen 5%
Versascreen 1%
Versascreen 5%
Versascreen 10%

Width ► Drop ▼	100cm 3'3"	125cm 4'1"	150cm 4'11"	175cm 5'8"	200cm 6'6"	225cm 7'4"	250cm 8'2"	275cm 9'0"	300cm 9'10"	330cm 10'10"	◀ Width ▼ Drop
50cm	299.73	329.93	360.20	390.45	424.68	450.89	481.12	511.35	541.56	577.86	1'8"
100cm	327.14	364.23	401.31	438.39	475.48	512.58	549.66	586.75	623.84	668.33	3'3"
150cm	354.56	398.51	442.44	486.35	530.32	574.24	618.21	662.15	706.11	758.83	4'11"
200cm	381.98	432.78	483.57	534.35	585.17	635.94	686.76	737.55	788.35	849.30	6'6"
250cm	409.39	467.04	524.71	582.36	639.99	697.65	755.30	812.95	870.61	928.27	8'2"
300cm	436.80	501.34	565.84	630.36	694.87	759.34	823.87	888.40	952.85	1030.29	9'10"
350cm	464.25	535.60	606.94	678.32	749.69	821.04	892.41	963.76	1035.14		11'6"
400cm	491.65	569.89	648.09	726.29	804.52	882.74	960.95	1039.18		Max. 10m ²	13'1"

Price Group 3R

Aluscreen Futura
Deep
Ecoscreen
Jumbotex
Lightscreen
Linea
Linea Alu
Mica
Moon

Newlife 1
Newlife 2
Reflex
Safescreen
Sevena
Treviscreen

Width ► Drop ▼	100cm 3'3"	125cm 4'1"	150cm 4'11"	175cm 5'8"	200cm 6'6"	225cm 7'4"	250cm 8'2"	275cm 9'0"	300cm 9'10"	330cm 10'10"	◀ Width ▼ Drop
50cm	345.73	387.47	429.18	470.93	512.66	554.41	596.12	637.88	679.61	729.67	1'8"
100cm	396.13	450.50	504.83	559.18	613.51	667.85	722.18	776.53	830.87	896.09	3'3"
150cm	446.58	513.52	580.46	647.41	714.36	781.33	848.26	915.18	982.13	1062.47	4'11"
200cm	497.00	576.54	656.08	735.65	815.19	894.76	974.31	1053.87	1133.42	1228.85	6'6"
250cm	547.42	639.58	731.74	823.89	916.06	1008.21	1100.35	1192.51	1284.67	1395.27	8'2"
300cm	597.82	702.60	807.38	912.15	1016.91	1121.67	1226.42	1331.18	1435.94	1561.67	9'10"
350cm	648.28	765.64	883.00	1000.37	1117.74	1235.09	1352.50	1469.86	1587.22		11'6"
400cm	698.69	828.67	958.64	1088.60	1218.59	1348.57	1478.55	1608.66		Max. 10m ²	13'1"

4830 – Hardware only

Headrail supplied ready-assembled including adhesive tape for customers to mount own fabric.
White aluminium bottom bar included as standard.

Width ►	100cm 3'3"	125cm 4'1"	150cm 4'11"	175cm 5'8"	200cm 6'6"	225cm 7'4"	250cm 8'2"	275cm 9'0"	300cm 9'10"	330cm 10'10"	◀ Width
	244.88	261.39	277.94	294.44	310.96	327.48	344.02	360.54	377.08	396.88	

Fascia 4702: Optional fascia covers roller blind headrail. Available in silver or white.

Pricing: Add to prices above the following: **£27.89/m width + £54.41/system**

Side-Guiding: Side-guide wires with accessories: Please add **£46.45** per system.

System 4830 – Double System

There is no add-on for a double system. Simply price as two separate systems and order a double system.

Prices shown
exclude VAT



Roller Blinds

System 4830 – Side-by-Side System

Heavy duty chain operated Roller Blind system.
 Tube diameter 55mm.
 Max. surface area 10m²
 (5m² for each panel of side by side system)

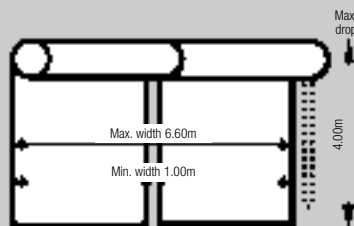

System 4830 – Side-by-Side System complete with fabric

The prices below comprise the complete system made-to-measure, ready to hang with fabric of your choice. Please be aware that due to the size capabilities of this system, larger sizes can only be achieved by welding the fabric. Fabrics that can be welded are indicated below in bold print. If a system is required as a double system smaller than widths indicated below, please add £79.71 to single system price.

Price Category C

Price Group 1R

Colorama 1
 Colorama 1 Alu
 Element
Puma

Width ▶ Drop ▼	350cm	375cm	400cm	425cm	450cm	475cm	500cm	525cm	550cm	575cm	600cm	625cm	660cm	◀Width ▼ Drop
50cm	635.90	660.85	685.74	710.62	735.55	760.45	785.34	810.24	835.17	860.04	884.96	909.85	944.75	1'8"
100cm	694.59	723.69	752.79	781.87	811.00	840.10	869.17	898.28	927.36	956.47	985.57	1014.64	1055.39	3'3"
150cm	753.27	786.55	819.84	853.15	886.44	919.73	952.99	986.29	1019.56	1052.87	1086.12	1119.46	1166.02	4'11"
200cm	811.96	849.42	886.88	924.37	961.86	999.32	1036.82	1074.30	1111.79	1149.24	1186.72	1224.20	1276.66	6'6"
250cm	870.61	912.29	953.96	995.60	1037.29	1078.97								8'2"
300cm	929.31	975.16												9'10"
350cm														11'6"
400cm														13'1"

Max. 10m²

Price Group 2R

Alutex
 Alutrans Pro
 Colorama 2
 Colorama 2 Alu
 Colorama 2 Bioactive
 Mercurio B
 Multi Shadow
 Multi Visio
Multiscreen 1%
Multiscreen 5%
Multiscreen 10%

Triscreen 1%
Triscreen 3%
Triscreen 5%
Versascreen 1%
Versascreen 5%
Versascreen 10%

Width ▶ Drop ▼	350cm	375cm	400cm	425cm	450cm	475cm	500cm	525cm	550cm	575cm	600cm	625cm	660cm	◀Width ▼ Drop
50cm	710.50	740.71	770.98	801.22	831.42	861.67	891.92	922.14	952.37	982.59	1012.83	1043.05	1085.40	1'8"
100cm	806.48	843.54	880.64	917.75	954.83	991.90	1029.01	1066.11	1103.18	1140.24	1177.31	1214.43	1266.35	3'3"
150cm	902.44	946.39	990.32	1034.28	1078.21	1122.12	1166.09	1210.05	1253.96	1297.92	1341.88	1385.79	1447.33	4'11"
200cm	998.42	1049.08	1100.00	1150.80	1201.60	1252.42	1303.21	1354.02	1404.82	1455.59	1506.39	1557.16	1628.30	6'6"
250cm	1094.40	1152.06	1209.69	1267.31	1324.99	1382.66								8'2"
300cm	1190.34	1254.86												9'10"
350cm														11'6"
400cm														13'1"

Max. 10m²

Price Group 3R

Aluscreen Futura
 Deep
 Ecoscreen
 Jumbotex
 Lightscreen
 Linea
 Linea Alu
 Mica
 Moon
 Newlife 1
 Newlife 2

Reflex
 Safescreen
 Sevena
 Treviscreen

Width ▶ Drop ▼	350cm	375cm	400cm	425cm	450cm	475cm	500cm	525cm	550cm	575cm	600cm	625cm	660cm	◀Width ▼ Drop
50cm	871.53	913.25	955.00	996.75	1038.49	1080.20	1121.94	1163.68	1205.43	1247.12	1288.89	1330.60	1389.04	1'8"
100cm	1048.00	1102.35	1156.68	1211.03	1265.37	1319.68	1374.05	1428.37	1482.76	1537.06	1591.44	1645.78	1721.82	3'3"
150cm	1224.48	1291.42	1358.38	1425.33	1492.29	1559.21	1626.16	1693.12	1760.04	1827.01	1893.96	1960.90	2054.61	4'11"
200cm	1400.99	1480.53	1560.09	1639.64	1719.19	1798.74	1878.30	1957.84	2037.38	2116.95	2196.50	2276.05	2387.42	6'6"
250cm	1577.46	1669.62	1761.79	1853.93	1946.06	2038.25								8'2"
300cm	1753.94	1858.69												9'10"
350cm														11'6"
400cm														13'1"

Max. 10m²

4830 Side-by-Side System – Hardware only

Double headrail system supplied ready-assembled including adhesive tape for customers to mount own fabric. White aluminium bottom bar included as standard.

Width ▶	100cm	150cm	200cm	250cm	300cm	350cm	400cm	450cm	500cm	550cm	600cm	660cm	◀Width
	3'3"	4'11"	6'6"	8'2"	9'10"	11'6"	13'1"	14'9"	16'5"	18'0"	19'8"	21'8"	
	353.33	386.39	419.44	452.50	485.51	518.55	551.64	584.65	617.71	650.73	683.80	723.43	

Fascia 4702: Optional fascia covers roller blind headrail. Available in silver or white.
Pricing: Add to prices above the following: £27.89/m width + £60.02/system

Side-Guiding: Side-guide wires with accessories: Please add £92.90 per double system.

Prices shown
 exclude VAT



Roller Blinds

System 4840

Heavy duty chain operated
Roller Blind system.
Tube diameter 80mm.
Max. surface area 15m²

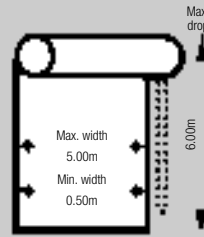

System 4840 complete with fabric

The prices below comprise the complete system made-to-measure, ready to hang with fabric of your choice. Please be aware that due to the size capabilities of this system, larger sizes can only be achieved by welding the fabric. Fabrics that can be welded are indicated below in bold print.

Price Category C

Price Group 1R

Colorama 1
Colorama 1 Alu
Element
Puma

Width ► Drop ▼	100cm 3'3"	150cm 4'11"	200cm 6'6"	250cm 8'2"	300cm 9'10"	350cm 11'6"	400cm 13'1"	450cm 14'9"	500cm 16'5"	◀ Width ▼ Drop
50cm	546.10	608.40	670.71	732.99	795.29	857.56	919.86	982.13	1044.43	1'8"
100cm	562.22	632.56	702.98	773.31	843.66	914.01	984.39	1054.72	1125.09	3'3"
150cm	578.35	656.78	735.20	813.63	892.03	970.48	1048.91	1127.32	1205.72	4'11"
200cm	594.47	680.98	767.46	853.95	940.40	1026.89	1113.42	1199.89	1286.39	6'6"
250cm	610.65	705.15	799.72	894.27	988.79	1083.36	1177.91	1272.47	1367.02	8'2"
300cm	626.73	729.33	831.98	934.59	1037.19	1139.80	1242.42	1345.00	1447.57	9'10"
350cm	642.88	753.52	864.23	974.91	1085.59	1196.25	1306.94			11'6"
400cm	659.02	777.74	896.49	1015.24	1133.99	1252.71				13'1"
450cm	675.14	801.94	928.74	1055.55	1182.34					14'9"
500cm	691.27	826.10	960.96	1095.89	1230.74					16'5"
550cm	707.39	850.32	993.24	1136.18						18'0"
600cm	723.53	874.50	1025.49	1176.50					Max. 15m ²	19'8"

Price Group 2R

Alutex
Alutrans Pro
Colorama 2
Colorama 2 Alu
Colorama 2 Bioactive
Mercurio B
Multi Shadow
Multi Visio
Multiscreen 1%
Multiscreen 5%
Multiscreen 10%

Triscreen 1%
Triscreen 3%
Triscreen 5%
Versascreen 1%
Versascreen 5%
Versascreen 10%

Width ► Drop ▼	100cm 3'3"	150cm 4'11"	200cm 6'6"	250cm 8'2"	300cm 9'10"	350cm 11'6"	400cm 13'1"	450cm 14'9"	500cm 16'5"	◀ Width ▼ Drop
50cm	566.58	639.07	711.64	784.17	856.70	929.26	1001.76	1074.28	1146.82	1'8"
100cm	592.92	678.67	764.35	850.07	935.79	1021.50	1107.24	1192.93	1278.65	3'3"
150cm	619.32	718.21	817.10	915.99	1014.88	1113.78	1212.68	1311.60	1410.50	4'11"
200cm	645.68	757.75	869.81	981.95	1094.00	1206.08	1318.19	1430.24	1542.28	6'6"
250cm	672.04	797.32	922.58	1047.85	1173.07	1298.33	1423.64	1548.86	1674.13	8'2"
300cm	698.41	836.86	975.30	1113.72	1252.19	1390.60	1529.08	1667.51	1805.98	9'10"
350cm	724.78	876.38	1028.01	1179.66	1331.29	1482.90	1634.54			11'6"
400cm	751.13	915.94	1080.75	1245.59	1410.39	1575.20				13'1"
450cm	777.51	955.46	1133.49	1311.49	1489.47					14'9"
500cm	803.85	995.04	1186.24	1377.40	1568.59					16'5"
550cm	830.26	1034.60	1238.95	1443.32						18'0"
600cm	856.61	1074.15	1291.68	1509.22					Max. 15m ²	19'8"

Price Group 3R

Aluscreen Futura
Deep
Ecoscreen
Jumbotex
Lightscreen
Linea
Linea Alu
Mica
Moon
Newlife 1
Newlife 2
Reflex
Safescreen
Severna
Treviscreen

Width ► Drop ▼	100cm 3'3"	150cm 4'11"	200cm 6'6"	250cm 8'2"	300cm 9'10"	350cm 11'6"	400cm 13'1"	450cm 14'9"	500cm 16'5"	◀ Width ▼ Drop
50cm	610.81	705.48	800.17	894.79	989.46	1084.11	1178.76	1273.44	1368.08	1'8"
100cm	659.29	778.20	897.12	1016.01	1134.91	1253.79	1372.74	1491.63	1610.52	3'3"
150cm	707.83	850.94	994.09	1137.24	1280.39	1423.57	1566.67	1709.82	1853.00	4'11"
200cm	756.30	923.67	1091.10	1258.48	1425.85	1593.26	1760.66	1928.06	2095.44	6'6"
250cm	804.79	996.43	1188.06	1379.73	1571.32	1762.98	1954.63	2146.25	2337.89	8'2"
300cm	853.28	1069.16	1285.05	1500.91	1716.82	1932.70	2148.57	2364.47	2580.39	9'10"
350cm	901.78	1141.90	1382.01	1622.17	1862.30	2102.42	2342.55			11'6"
400cm	950.25	1214.63	1479.02	1743.39	2007.78	2272.13				13'1"
450cm	998.77	1287.34	1575.99	1864.64	2153.23					14'9"
500cm	1047.25	1360.12	1672.97	1985.82	2298.72					16'5"
550cm	1095.72	1432.85	1769.97	2107.07						18'0"
600cm	1144.21	1505.56	1866.92	2228.33					Max. 15m ²	19'8"

Note: All fabrics are FR

System 4840 – Double System

There is no add-on for a double system. Simply price as two separate systems and order a double system.

Side-Guiding of System 4840 Side-guide wires are available as an option. Please add £159.31 per system (Cat. 'C').

Prices shown exclude VAT



Roller Blinds

System 4960

Electric roller blind system.
Mains voltage.

Speed: 12cm/sec. approx.

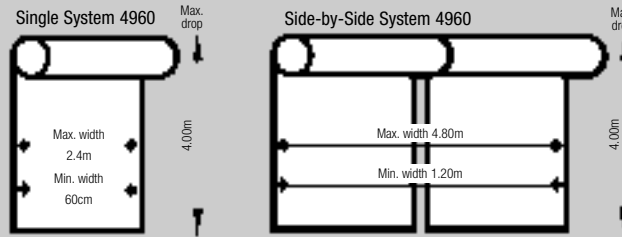

System 4960 complete with fabric

The prices below comprise the complete system made-to-measure, ready to hang with fabric of your choice. System sizes in shaded areas available as side-by-side systems only.

Price Category C

Price Group 1R

Colorama 1
Colorama 1 Alu
Element
Puma

Width ▶ Drop ▼	100cm 3'3"	125cm 4'1"	150cm 4'11"	175cm 5'8"	200cm 6'6"	225cm 7'5"	240cm 7'10"	250cm 8'2"	275cm 9'0"	300cm 9'10"	325cm 10'10"	350cm 11'6"	375cm 12'4"	400cm 13'1"	425cm 13'11"	450cm 14'9"	460cm 15'1"	480cm 15'9"	◀ Width ▼ Drop
50cm	673.37	686.18	698.99	711.77	724.57	737.38	757.89	775.88	788.65	801.42	814.26	827.05	839.42	851.76	864.12	878.45	883.78	894.45	1'8"
100cm	686.68	702.80	718.93	735.08	751.15	767.23	789.80	809.12	825.23	841.32	857.46	873.56	889.72	905.82	921.95	938.10	944.55	957.45	3'3"
150cm	699.97	719.40	738.87	758.33	777.76	797.20	821.72	842.35	861.77	881.20	900.63	920.10	939.56	959.01	978.45	997.92	1005.67	1021.18	4'11"
200cm	713.28	736.04	758.83	781.62	804.32	827.03	853.64	875.58	898.31	921.09	943.86	966.62	989.44	1012.16	1034.95	1057.72	1066.81	1084.99	6'6"
250cm	726.57	752.67	778.74	804.84	830.94	857.04	885.52	908.81	934.87	960.95	987.04	1013.14	1039.26	1065.36	1091.44	1117.53	1127.97	1148.85	8'2"
300cm	739.84	769.29	798.72	828.12	857.54	886.95	917.44	942.07	971.47	1000.89	1030.29	1059.69	1089.12	1118.53	1147.95				9'10"
350cm	753.16	785.90	818.63	851.38	884.09	916.81	949.36	975.29	1008.06	1040.78	1073.53	1106.21	1138.98	1171.72	1204.46				11'6"
400cm	766.46	802.51	838.54	874.62	910.64	946.66	981.27	1008.50	1044.65	1080.65	1116.76	1152.73	1188.85	1224.92	1260.98			Max. 12m ²	13'1"

Price Group 2R

Alutex
Alutrans Pro
Colorama 2
Colorama 2 Alu
Colorama 2 Bioactive
Mercurio B
Multi Shadow
Multi Visio
Multiscreen 1%
Multiscreen 5%
Multiscreen 10%

Triscreen 1%
Triscreen 3%
Triscreen 5%
Versascreen 1%
Versascreen 5%
Versascreen 10%

Width ▶ Drop ▼	100cm 3'3"	125cm 4'1"	150cm 4'11"	175cm 5'8"	200cm 6'6"	225cm 7'5"	240cm 7'10"	250cm 8'2"	275cm 9'0"	300cm 9'10"	325cm 10'10"	350cm 11'6"	375cm 12'4"	400cm 13'1"	425cm 13'11"	450cm 14'9"	460cm 15'1"	480cm 15'9"	◀ Width ▼ Drop
50cm	688.57	705.15	721.74	738.32	754.93	772.06	794.34	813.77	830.37	846.97	863.57	880.17	896.78	913.35	929.95	946.55	953.18	966.47	1'8"
100cm	710.28	732.34	754.34	776.39	798.39	820.38	846.48	868.15	890.15	912.16	934.19	956.22	978.25	1000.26	1022.31	1044.31	1053.13	1070.79	3'3"
150cm	732.03	759.47	786.94	814.39	841.85	869.30	898.62	922.46	949.90	977.38	1004.80	1032.26	1059.72	1087.15	1114.62	1142.07	1153.06	1175.04	4'11"
200cm	753.75	786.63	819.51	852.41	885.31	918.21	950.77	976.78	1009.64	1042.52	1075.42	1108.30	1141.19	1174.07	1206.82	1239.87	1253.03	1279.34	6'6"
250cm	775.49	813.77	852.12	890.41	928.75	967.10	1002.91	1031.08	1069.40	1107.72	1146.06	1184.37	1222.69	1260.99	1299.29	1337.67	1352.96	1383.53	8'2"
300cm	797.18	840.95	884.68	928.45	972.22	1015.98	1055.05	1085.39	1129.16	1172.88	1216.65	1260.37	1304.14	1347.93	1391.61				9'10"
350cm	818.93	868.15	917.30	966.48	1015.65	1064.82	1107.19	1139.71	1188.92	1238.10	1287.26	1336.43	1385.61	1434.81	1483.97				11'6"
400cm	840.68	895.34	949.92	1023.60	1059.09	1113.67	1159.32	1194.01	1248.68	1303.33	1357.88	1412.48	1467.08	1521.70	1576.34			Max. 12m ²	13'1"

Price Group 3R

Aluscreen Futura
Deep
Ecoscreen
Jumbotex
Lightscreen
Linea
Linea Alu
Mica
Moon

Newlife 1
Newlife 2
Reflex
Safescreen
Sevena
Treviscreen

Width ▶ Drop ▼	100cm 3'3"	125cm 4'1"	150cm 4'11"	175cm 5'8"	200cm 6'6"	225cm 7'5"	240cm 7'10"	250cm 8'2"	275cm 9'0"	300cm 9'10"	325cm 10'10"	350cm 11'6"	375cm 12'4"	400cm 13'1"	425cm 13'11"	450cm 14'9"	460cm 15'1"	480cm 15'9"	◀ Width ▼ Drop
50cm	721.37	746.19	770.99	795.76	820.57	845.39	873.10	895.85	920.64	945.46	970.23	995.03	1019.81	1044.61	1069.40	1094.23	1104.16	1124.03	1'8"
100cm	761.35	796.13	830.90	865.72	900.49	935.27	969.00	995.77	1030.55	1065.30	1100.14	1134.91	1169.70	1204.46	1239.25	1274.06	1287.94	1315.72	3'3"
150cm	801.29	846.05	890.85	935.64	980.38	1025.14	1064.89	1095.66	1140.45	1185.23	1229.96	1274.74	1319.55	1364.32	1409.11	1453.87	1471.77	1507.56	4'11"
200cm	841.24	896.02	950.81	1005.57	1060.31	1115.07	1160.79	1195.54	1250.32	1305.07	1359.84	1414.60	1469.38	1524.14	1578.91	1633.68	1655.59	1699.41	6'6"
250cm	881.20	945.96	1010.74	1075.51	1140.21	1204.91	1256.68	1295.42	1360.18	1424.95	1489.71	1554.46	1619.21	1683.97	1748.73	1813.48	1839.42	1891.30	8'2"
300cm	921.18	995.92	1070.71	1145.43	1220.17	1294.92	1352.60	1395.35	1470.08	1544.84	1619.60	1694.29	1769.06	1843.78	1918.09				9'10"
350cm	961.15	1045.88	1130.59	1215.34	1300.09	1384.85	1448.50	1495.23	1579.93	1664.70	1749.42	1834.20	1918.89	2003.65	2088.37				11'6"
400cm	1001.13	1095.84	1190.47	1285.23	1380.00	1474.78	1544.39	1595.12	1689.77	1784.56	1879.25	1974.11	2068.73	2163.52	2258.66			Max. 12m ²	13'1"

System 4960 Control Options

Radio control standard option is with System 0450, see page 26.

Radio control option with integrated receiver available only with 9940 controls - add on £148.95, see page 26.

System 4960 – Hardware only

Headrail supplied ready-assembled including adhesive tape for customers to mount own fabric. White aluminium bottom bar included as standard. System sizes in shaded areas available as double systems only.

Width ▶	100cm 3'3"	125cm 4'1"	150cm 4'11"	175cm 5'8"	200cm 6'6"	225cm 7'5"	240cm 7'10"	250cm 8'2"	275cm 9'0"	300cm 9'10"	325cm 10'10"	350cm 11'6"	375cm 12'4"	400cm 13'1"	425cm 13'11"	450cm 14'9"	460cm 15'1"	480cm 15'9"	◀ Width
	630.54	637.15	643.80	650.40	657.03	663.65	676.74	707.96	714.57	721.14	727.78	734.38	740.97	747.57	754.21	760.80	763.62	769.27	

Note: If a side-by-side system is required below 2.30m (e.g. for fabric reasons) please add £34.83 to single system price.

For side guided option add £37.76 per system.

Prices shown exclude VAT



Roller Blinds

System 4870

Heavy duty electrically operated Roller Blind system. Mains voltage. Speed approx. 7cm/sec. Tube diameter 55mm. Max. surface area 14m²

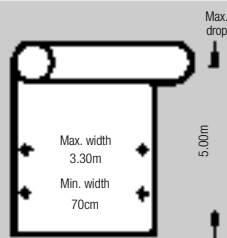

System 4870 complete with fabric

The prices below comprise the complete system made-to-measure, ready to hang with fabric of your choice. Please be aware that due to the size capabilities of this system, larger sizes can only be achieved by welding the fabric. Fabrics that can be welded are indicated below in bold print.

Price Category C

Price Group 1R

Colorama 1
Colorama 1 Alu
Element
Puma

Width ► Drop ▼	100cm 3'3"	125cm 4'1"	150cm 4'11"	175cm 5'8"	200cm 6'6"	225cm 7'5"	250cm 8'2"	275cm 9'0"	300cm 9'10"	330cm 10'10"	◀ Width ▼ Drop
50cm	938.58	957.72	976.88	996.05	1015.18	1034.33	1053.48	1072.65	1091.79	1114.77	1'8"
100cm	955.19	978.48	1001.79	1025.11	1048.41	1071.70	1095.01	1118.30	1141.60	1169.55	3'3"
150cm	971.81	999.25	1026.70	1054.16	1081.61	1109.05	1136.49	1163.95	1191.42	1224.36	4'11"
200cm	988.39	1019.98	1051.58	1083.21	1114.82	1146.42	1178.00	1209.61	1241.23	1279.14	6'6"
250cm	1005.01	1040.77	1076.51	1112.26	1148.03	1183.76	1219.52	1255.29	1291.03	1333.92	8'2"
300cm	1021.60	1061.49	1101.43	1141.30	1181.21	1221.15	1261.05	1300.94	1340.85	1388.74	9'10"
350cm	1038.21	1082.25	1126.34	1170.39	1214.44	1258.48	1302.52	1346.60	1390.63	1443.50	11'6"
400cm	1054.81	1103.02	1151.22	1199.44	1247.64	1295.83	1344.06	1392.26	1440.46	1498.30	13'1"
450cm	1071.42	1123.75	1176.15	1228.48	1280.86	1333.19	1385.57	1437.91	1490.28		14'9"
500cm	1088.00	1144.52	1201.02	1257.53	1314.04	1370.56	1427.08	1483.55		Max. 14m ²	16'5"

Price Group 2R

Alutex
Alutrans Pro
Colorama 2
Colorama 2 Alu
Colorama 2 Bioactive
Mercurio B
Multi Shadow
Multi Visio
Multiscreen 1%
Multiscreen 5%
Multiscreen 10%

Triscreen 1%
Triscreen 3%
Triscreen 5%
Versascreen 1%
Versascreen 5%
Versascreen 10%

Width ► Drop ▼	100cm 3'3"	125cm 4'1"	150cm 4'11"	175cm 5'8"	200cm 6'6"	225cm 7'5"	250cm 8'2"	275cm 9'0"	300cm 9'10"	330cm 10'10"	◀ Width ▼ Drop
50cm	949.15	970.92	992.70	1014.50	1036.30	1058.08	1079.87	1101.65	1123.45	1149.58	1'8"
100cm	976.30	1004.87	1033.44	1062.02	1090.63	1119.18	1147.78	1176.33	1204.90	1239.22	3'3"
150cm	1003.47	1038.82	1074.19	1109.54	1144.92	1180.28	1215.65	1251.02	1286.40	1328.82	4'11"
200cm	1030.60	1072.78	1114.92	1157.08	1199.23	1241.37	1283.54	1325.69	1367.86	1418.43	6'6"
250cm	1057.75	1106.71	1155.66	1204.60	1253.56	1302.48	1351.44	1400.37	1449.31	1508.04	8'2"
300cm	1084.92	1140.65	1196.39	1252.14	1307.84	1363.60	1419.32	1475.06	1530.80	1597.67	9'10"
350cm	1112.08	1174.56	1237.11	1299.64	1375.78	1424.70	1487.23	1549.73	1612.28	1687.30	11'6"
400cm	1139.24	1208.53	1277.87	1347.16	1416.50	1485.81	1555.11	1624.42	1693.71	1776.90	13'1"
450cm	1166.40	1242.47	1318.59	1394.69	1470.79	1546.90	1623.01	1699.09	1775.22		14'9"
500cm	1193.51	1276.45	1359.33	1442.23	1525.10	1607.99	1690.88	1773.80		Max. 14m ²	16'5"

Price Group 3R

Aluscreen Futura
Deep
Ecoscreen
Jumbotex
Lightscreen
Linea
Linea Alu
Mica
Moon
Newlife 1
Newlife 2

Reflex
Safescreen
Sevena
Treviscreen

Width ► Drop ▼	100cm 3'3"	125cm 4'1"	150cm 4'11"	175cm 5'8"	200cm 6'6"	225cm 7'5"	250cm 8'2"	275cm 9'0"	300cm 9'10"	330cm 10'10"	◀ Width ▼ Drop
50cm	971.93	999.38	1026.87	1054.39	1081.86	1109.34	1136.81	1164.28	1191.81	1224.76	1'8"
100cm	1021.86	1061.82	1101.80	1141.76	1181.76	1221.71	1261.67	1301.64	1341.62	1389.57	3'3"
150cm	1071.81	1124.25	1176.72	1229.15	1281.60	1334.10	1386.53	1438.96	1491.44	1554.37	4'11"
200cm	1121.72	1186.67	1251.60	1316.56	1381.50	1446.42	1511.38	1576.30	1641.24	1719.19	6'6"
250cm	1171.68	1249.09	1326.52	1403.94	1481.39	1558.80	1636.22	1713.66	1791.09	1883.95	8'2"
300cm	1221.63	1311.52	1401.44	1491.35	1581.25	1671.18	1761.07	1850.96	1940.87	2048.74	9'10"
350cm	1271.56	1373.93	1476.35	1578.72	1681.14	1783.52	1885.91	1988.29	2090.70	2213.57	11'6"
400cm	1321.48	1436.36	1551.25	1666.12	1781.02	1895.89	2010.78	2125.65	2240.53	2378.34	13'1"
450cm	1371.43	1498.77	1626.16	1753.52	1880.89	2008.25	2135.60	2262.96	2390.35		14'9"
500cm	1421.35	1561.21	1701.08	1840.90	1980.77	2120.58	2260.46	2400.31		Max. 14m ²	16'5"

Note: All fabrics are FR

System 4870 Control Options

Radio control standard option is with System 0450, see page 26.

Radio control option with integrated receiver available only with 9940 controls - add on £148.95, see page 26.

System 4870 – Hardware only

Headrail system supplied ready-assembled including adhesive tape for customers to mount own fabric.

Bottom bar in white is included as standard.

Width ►	100cm 3'3"	125cm 4'1"	150cm 4'11"	175cm 5'8"	200cm 6'6"	225cm 7'5"	250cm 8'2"	275cm 9'0"	300cm 9'10"	330cm 10'10"	◀ Width
	921.96	936.99	951.96	966.97	981.99	996.97	1012.01	1026.98	1041.99	1059.99	

Fascia 4702: Optional fascia covers roller blind headrail. Available in silver or white.

Pricing: Add to prices above the following: **£27.89/m width + £53.90/system**

Side-Guiding: Side-guide wires with accessories: Please add **£58.94** per system.

System 4870 – Double Bracket System

There is no add-on for a double system. Simply price as two separate systems and order a double system.

Prices shown exclude VAT



Roller Blinds

System 4870 – Side-by-Side System

Heavy duty electrically operated Roller Blind system. Mains voltage. Speed approx. 7cm/sec. Tube diameter 55mm.

Max. surface area 22m²
(11m² for each panel of side by side system)

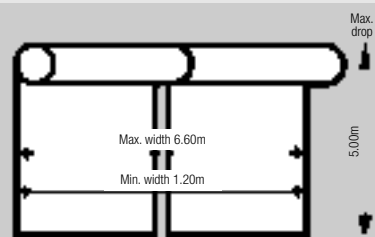

System 4870 – Side-by-Side System

The prices below comprise the complete system made-to-measure, ready to hang with fabric of your choice. Please be aware that due to the size capabilities of this system, larger sizes can only be achieved by welding the fabric. Fabrics that can be welded are indicated below in bold print. If a system is required as a double system smaller than widths indicated below, please add £73.52 to single system price.

Price Category C

Price Group 1R

Colorama 1
Colorama 1 Alu
Element
Puma

Width ► Drop ▼	350cm 11'6"	375cm	400cm 13'1"	425cm	450cm 14'9"	475cm	500cm 16'5"	525cm	550cm 18'0"	575cm	600cm 19'8"	625cm	660cm	◀Width ▼ Drop
50cm	1223.99	1243.15	1262.32	1281.47	1300.62	1319.74	1338.91	1358.08	1377.20	1396.37	1415.50	1434.66	1461.47	1'8"
100cm	1282.11	1305.41	1328.71	1352.03	1375.32	1398.63	1421.95	1445.24	1468.55	1491.82	1515.13	1538.44	1571.05	3'3"
150cm	1340.22	1367.65	1395.11	1422.59	1450.03	1477.48	1504.94	1532.38	1559.83	1587.27	1614.75	1642.22	1680.61	4'11"
200cm	1398.36	1429.95	1461.55	1493.15	1524.75	1556.34	1587.94	1619.58	1651.17	1682.79	1714.36	1745.95	1790.22	6'6"
250cm	1456.45	1492.22	1527.96	1563.72	1599.47	1635.21	1670.97	1706.75	1742.48	1778.25	1813.98	1849.75	1899.79	8'2"
300cm	1514.58	1554.48	1594.39	1634.28	1674.18	1714.10	1753.99	1793.88	1833.79	1873.71	1913.61	1953.51	2009.39	9'10"
350cm	1572.68	1616.72	1660.79	1704.85	1748.91	1792.93	1837.02	1881.04	1925.12	1969.17	2013.24	2057.30		11'6"
400cm	1630.77	1679.00	1727.23	1775.36	1823.60	1871.81	1920.03	1968.23	2016.43	2064.65	2112.87			13'1"
450cm	1688.88	1741.26	1793.63	1846.00	1898.34	1950.70	2003.05	2055.42						14'9"
500cm	1746.98	1803.52	1860.03	1916.54	1973.04									16'5"

Price Group 2R

Alutex
Alutrans Pro
Colorama 2
Colorama 2 Alu
Colorama 2 Bioactive
Mercuro B
Multi Shadow
Multi Visio
Multiscreen 1%
Multiscreen 5%
Multiscreen 10%

Triscreen 1%
Triscreen 3%
Triscreen 5%
Versascreen 1%
Versascreen 5%
Versascreen 10%

Width ► Drop ▼	350cm 11'6"	375cm	400cm 13'1"	425cm	450cm 14'9"	475cm	500cm 16'5"	525cm	550cm 18'0"	575cm	600cm 19'8"	625cm	660cm	◀Width ▼ Drop
50cm	1260.93	1282.70	1304.51	1326.31	1348.08	1369.88	1391.63	1413.47	1435.25	1457.03	1478.81	1500.60	1531.14	1'8"
100cm	1355.97	1384.57	1413.46	1441.72	1470.29	1498.87	1527.44	1556.03	1584.60	1613.16	1641.78	1670.34	1710.34	3'3"
150cm	1451.03	1486.40	1521.76	1557.12	1592.49	1627.88	1663.23	1698.58	1733.95	1769.31	1804.69	1840.05	1889.59	4'11"
200cm	1546.07	1588.23	1630.40	1672.54	1714.68	1756.87	1799.02	1841.17	1883.34	1925.47	1967.63	2009.81	2068.81	6'6"
250cm	1641.13	1690.08	1739.03	1787.97	1836.90	1885.87	1934.78	1983.74	2032.67	2081.64	2130.58	2179.53	2248.06	8'2"
300cm	1736.18	1791.89	1847.63	1903.38	1959.09	2014.87	2070.59	2126.31	2182.06	2237.79	2293.51	2349.25	2427.26	9'10"
350cm	1831.23	1893.72	1956.29	2018.80	2081.34	2143.84	2206.35	2268.90	2331.39	2393.93	2456.45	2518.97		11'6"
400cm	1926.26	1995.60	2064.89	2134.20	2203.53	2272.84	2342.13	2411.51	2480.76	2550.10	2619.36			13'1"
450cm	2021.30	2097.42	2173.52	2249.61	2325.73	2401.81	2477.91	2554.03						14'9"
500cm	2116.36	2199.27	2282.18	2365.03	2447.94									16'5"

Price Group 3R

Aluscreen Futura
Deep
Ecoscreen
Jumbotex
Lightscreen
Linea
Linea Alu
Mica
Moon
Newlife 1
Newlife 2
Reflex
Safescreen
Sevena
Treviscreen

Width ► Drop ▼	350cm 11'6"	375cm	400cm 13'1"	425cm	450cm 14'9"	475cm	500cm 16'5"	525cm	550cm 18'0"	575cm	600cm 19'8"	625cm	660cm	◀Width ▼ Drop
50cm	1340.66	1368.14	1395.66	1423.13	1450.63	1478.09	1505.56	1505.56	1615.51	1588.03	1615.51	1642.99	1681.50	1'8"
100cm	1515.46	1555.42	1595.40	1635.35	1675.36	1715.32	1755.28	1795.25	1835.22	1875.19	1915.61	1955.13	2011.08	3'3"
150cm	1690.24	1742.41	1795.18	1847.61	1900.09	1952.51	2004.98	2057.41	2109.87	2162.33	2214.79	2267.23	2340.68	4'11"
200cm	1865.04	1929.97	1994.91	2059.85	2124.77	2189.73	2254.67	2319.59	2384.54	2449.49	2514.44	2579.38	2670.25	6'6"
250cm	2039.81	2117.24	2194.68	2272.09	2349.51	2426.95	2504.34	2581.78	2659.21	2736.64	2814.05	2891.47	2999.90	8'2"
300cm	2214.61	2304.50	2394.43	2484.34	2574.25	2664.16	2754.08	2843.93	2933.87	3023.78	3113.66	3203.59	3329.49	9'10"
350cm	2389.42	2491.79	2594.19	2696.58	2798.98	2901.35	3003.76	3106.17	3208.53	3310.96	3413.34	3515.72		11'6"
400cm	2564.19	2679.07	2793.94	2908.82	3023.67	3138.55	3253.45	3368.34	3483.21	3598.10				13'1"
450cm	2738.97	2866.30	2993.71	3121.06	3248.41	3375.78	3503.13	3631.34			3712.95			14'9"
500cm	2913.73	3053.64	3193.47	3333.31										16'5"

System 4870 Side-by-Side Control Options

Radio control standard option is with System 0450, see page 26.

Radio control option with integrated receiver available only with 9940 controls - add on £148.95, see page 26.

System 4870 Side-by-Side System – Hardware only

Double headrail system supplied ready-assembled including adhesive tape for customers to mount own fabric. Bottom bar in white is included as standard.

Width ► Drop ▼	100cm 3'3"	150cm 4'11"	200cm 6'6"	250cm 8'2"	300cm 9'10"	350cm 11'6"	400cm 13'1"	450cm 14'9"	500cm 16'5"	550cm 18'0"	600cm 19'8"	660cm 21'8"	◀Width ▼ Drop
	1015.88	1045.89	1075.91	1105.88	1135.87	1165.90	1195.90	1225.85	1255.89	1285.88	1315.88	1351.86	

Fascia 4702: Optional fascia covers roller blind headrail. Available in silver or white.

Pricing: Add to prices above the following: £27.89/m width + £61.49/system

Side-Guiding: Side-guide wires with accessories: Please add £92.04 per side-by-side system.

Prices shown exclude VAT

Note: All fabrics are FR.



Dim-out Roller Blinds

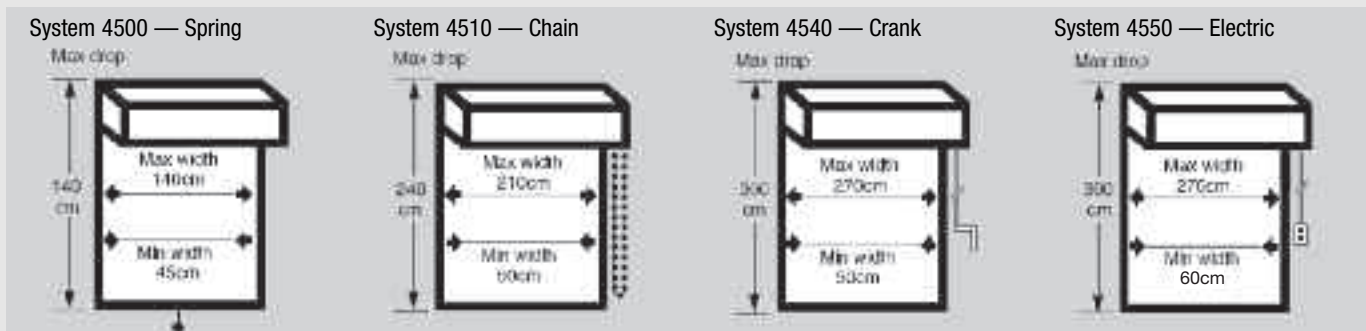

Price category C

The prices in the tables comprise the complete system made-to-measure, with fabric chosen, ready to install.

If sizes lie between the measurements shown, the price for the next larger size will apply.

As components vary, please always state if blind is fitted inside or outside recess.

Colours: White or black available as standard. Silver/bronze anodized or standard RAL colours are available at extra cost as follows:-

Inside Recess: £40.12/m width Price cat. 'C'
£80.29/m drop Price cat. 'C'

Outside recess: £60.23/m width Price cat. 'C'
£80.02/m drop Price cat. 'C'

Charges are for headrail/side legs — + bottom rails only, accessories available in white or black only.

Optional bottom bar combination 4511/12 for inside recess applications: £19.52 per metre width (standard white or black).

Application Chart

Always ensure the fabric chosen for your Dim-out Blind can be fitted within the following guidelines, also check if hardware allows size required.

	To Max Drop Width	To Max Drop Drop	or	To Max Width Width	To Max Width Drop
Puma	270	300		270	300
Mercurio B (01, 04, 28)*	210	300		210	300
Mercurio B (other colours)	210	300		210	300
Moon	225	300		225	300

Note: Laminated customer own fabric not available.

* If welded, white not recommended as discolours.

System 4500

Price Group 1R

Puma

Width	60cm/2'0"	80cm/2'7"	100cm/3'3"	120cm/3'11"	140cm/4'7"	Width
Drop (cm)						Drop ft/ins
40	186.71	212.49	238.22	263.96	289.71	1'4"
60	201.59	228.68	255.75	282.88	309.94	2'0"
80	216.46	244.87	273.34	301.75	330.20	2'7"
100	231.32	261.13	290.90	320.69	350.44	3'3"
120	246.24	277.32	308.42	339.52	370.65	3'11"
140	261.11	293.53	326.03	358.49	390.91	4'7"

Price Group 2R

Mercurio B

Width	60cm/2'0"	80cm/2'7"	100cm/3'3"	120cm/3'11"	140cm/4'7"	Width
Drop (cm)						Drop ft/ins
40	191.60	219.02	246.38	273.74	301.14	1'4"
60	208.93	238.47	268.00	297.55	327.07	2'0"
80	226.25	257.92	289.66	321.33	353.02	2'7"
100	243.54	277.45	311.29	345.14	378.99	3'3"
120	260.93	296.90	332.90	368.87	404.89	3'11"
140	278.24	316.37	354.58	392.74	430.87	4'7"

Price Group 3R

Moon

Width	60cm/2'0"	80cm/2'7"	100cm/3'3"	120cm/3'11"	140cm/4'7"	Width
Drop (cm)						Drop ft/ins
40	202.09	233.02	263.87	294.73	325.61	1'4"
60	224.67	259.46	294.23	329.02	363.80	2'0"
80	247.24	285.92	324.64	363.29	402.00	2'7"
100	269.79	312.44	355.01	397.62	440.21	3'3"
120	292.41	338.89	385.37	431.86	478.36	3'11"
140	314.97	365.35	415.79	466.20	516.59	4'7"

All prices shown exclude VAT



Dim-Out Roller Blind System 4510

Price category C

Price Group 1R - Puma

Width	60cm/2'0"	80cm/2'7"	100cm/3'3"	120cm/3'11"	140cm/4'7"	160cm/5'3"	180cm/5'11"	200cm/6'6"	210cm/6'10"	Width
Drop cm										Drop ft/ins
60	215.65	245.35	275.03	304.73	334.40	384.39	415.91	552.93	569.75	2'0"
80	230.25	261.27	292.26	323.24	354.30	405.54	438.39	576.73	594.21	2'7"
100	244.81	277.15	309.52	341.82	374.14	426.76	460.85	600.51	618.67	3'3"
120	259.44	293.04	326.70	360.35	393.98	447.93	483.36	624.32	643.12	3'11"
140	274.00	309.00	343.97	378.88	413.85	469.12	505.86	648.13	667.60	4'7"
160	299.91	337.95	376.03	414.11	452.21	490.27	528.35	671.96	692.06	5'8"
180	314.47	353.90	393.26	432.63	472.08	511.49	550.90	695.75	716.55	5'11"
200	329.07	369.77	410.51	451.24	491.93	532.65	573.36	719.59	741.00	6'6"
220	343.67	385.69	427.73	469.77	511.80	553.83	595.88	743.39	765.51	7'8"
240	358.28	401.60	444.95	488.30	531.63	575.03	618.36	767.17	789.96	7'10"

Price category C

Price Group 2R - Mercurio B

Width	60cm/2'0"	80cm/2'7"	100cm/3'3"	120cm/3'11"	140cm/4'7"	160cm/5'3"	180cm/5'11"	200cm/6'6"	210cm/6'10"	Width
Drop cm										Drop ft/ins
60	222.97	255.13	287.26	319.40	351.52	403.95	437.93	577.40	595.45	2'0"
80	240.03	274.31	308.59	342.81	377.13	431.64	467.75	609.34	628.45	2'7"
100	257.05	293.46	329.90	366.29	402.68	459.37	497.55	641.28	661.50	3'3"
120	274.11	312.61	351.17	389.71	428.21	487.07	527.40	673.26	694.51	3'11"
140	291.12	331.84	372.50	413.12	453.82	514.78	557.25	705.21	727.55	4'7"
160	319.48	364.04	408.64	453.26	497.88	542.47	587.06	737.20	760.56	5'8"
180	336.49	383.25	429.96	476.68	523.46	570.21	616.97	769.17	793.62	5'11"
200	353.55	402.39	451.27	500.17	549.02	597.92	646.76	801.12	826.66	6'6"
220	370.57	421.57	472.55	523.61	574.60	625.60	676.62	833.11	859.71	7'8"
240	387.63	440.74	493.90	547.02	600.15	653.32	706.44	865.05	892.71	7'10"

Price category C

Price Group 3R - Moon

Width	60cm/2'0"	80cm/2'7"	100cm/3'3"	120cm/3'11"	140cm/4'7"	160cm/5'3"	180cm/5'11"	200cm/6'6"	210cm/6'10"	Width
Drop cm										Drop ft/ins
60	238.72	276.12	313.51	350.88	388.27	445.95	485.16	629.86	650.55	2'0"
80	261.01	302.31	343.57	384.79	426.12	487.62	530.73	679.32	701.93	2'7"
100	283.28	328.46	373.63	418.75	463.91	529.35	576.26	728.76	753.33	3'3"
120	305.60	354.60	403.64	452.69	501.70	571.03	621.88	778.22	804.70	3'11"
140	327.87	380.82	433.71	486.59	539.54	612.75	667.46	827.67	856.13	4'7"
160	361.46	420.02	478.61	537.24	595.83	654.43	713.01	877.13	907.49	5'8"
180	383.72	446.23	508.67	571.14	633.66	696.17	758.65	926.60	958.93	5'11"
200	406.01	472.36	538.73	605.14	671.46	737.83	804.18	976.07	1010.33	6'6"
220	428.30	498.54	568.77	639.05	709.28	779.52	849.79	1025.53	1061.73	7'8"
240	450.60	524.70	598.82	672.97	747.09	821.24	895.35	1074.96	1113.12	7'10"

All prices shown exclude VAT



Dim-Out Roller Blind System 4540

Price category C

Price Group 1R - Puma

Width	60cm/2'0"	80cm/2'7"	100cm/3'3"	120cm/3'11"	140cm/4'7"	160cm/5'3"	180cm/5'11"	200cm/6'6"	220cm/7'3"	240cm/7'10"	260cm/8'6"	270cm/8'10"	Width
Drop (cm)													Drop ft/ins
60	403.47	435.59	467.66	499.78	531.87	564.03	596.08	628.17	882.00	916.98	951.94	969.46	2'0"
80	418.33	451.78	485.24	518.70	552.15	585.60	619.02	652.46	917.23	953.54	989.84	1007.99	2'7"
100	433.23	467.99	502.80	537.58	572.40	607.19	641.94	676.67	952.43	990.10	1027.73	1046.58	3'3"
120	448.09	484.23	520.34	556.48	592.60	628.79	664.90	706.53	987.66	1026.63	1065.63	1085.12	3'11"
140	462.99	500.46	537.92	575.40	612.88	650.30	687.82	725.32	1022.86	1063.17	1103.49	1123.65	4'7"
160	477.84	516.67	555.48	594.29	633.14	671.90	710.75	749.55	1058.05	1099.72	1141.42	1162.25	5'8"
180	492.71	532.92	573.04	613.21	653.37	693.52	733.73	773.88	1093.27	1136.28	1179.29	1200.82	5'11"
200	647.72	692.06	736.43	780.81	825.10	868.91	913.85	958.24	1128.45	1172.83	1217.15	1239.38	6'6"
220	662.61	708.30	753.99	799.67	845.39	891.04	936.81	982.47	1163.66	1209.35	1255.08	1277.95	7'8"
240	677.47	724.50	771.56	818.58	865.64	912.67	959.71	1006.79	1198.85	1245.91	1292.98	1316.46	7'10"
260	692.34	740.73	789.12	837.51	885.86	934.26	982.65	1031.05	1234.06	1282.47	1330.86	1355.04	8'6"
280	707.22	756.97	806.67	856.39	906.12	955.81	1005.58	1055.31	1269.27	1319.06	1368.72	1393.62	9'2"
300	722.08	773.18	824.23	875.30	926.37	977.44	1028.53	1079.59	1304.52	1355.56	1406.62	1432.16	9'10"

NOTE: Systems above 2.10m are supplied with heavy duty side profiles 4515/16. Should these be required for systems under 2.10m please add 15% to price in table above.

Price category C

Price Group 2R - Mercurio B

Width	60cm/2'0"	80cm/2'7"	100cm/3'3"	120cm/3'11"	140cm/4'7"	160cm/5'3"	180cm/5'11"	200cm/6'6"	220cm/7'3"	240cm/7'10"	260cm/8'6"	270cm/8'10"	Width
Drop (cm)													Drop ft/ins
60	410.81	445.38	479.91	514.46	549.00	583.60	618.09	652.65	907.71	946.35	983.74	1003.71	2'0"
80	428.13	464.81	501.56	538.26	574.99	611.69	648.36	685.09	951.48	992.68	1032.26	1053.67	2'7"
100	445.45	484.32	523.18	562.02	600.95	639.82	678.65	717.45	995.25	1039.03	1080.75	1103.67	3'3"
120	462.79	503.81	544.81	585.85	626.85	667.94	708.94	755.45	1039.03	1085.35	1129.24	1153.63	3'11"
140	480.11	523.30	566.46	609.65	652.84	695.97	739.21	782.40	1082.81	1131.69	1177.70	1203.61	4'7"
160	497.42	542.77	588.09	633.43	678.82	724.09	769.45	814.80	1126.56	1178.00	1226.22	1253.58	5'8"
180	514.74	562.29	609.76	657.25	704.75	752.23	799.78	847.29	1170.34	1224.34	1274.73	1303.58	5'11"
200	672.18	724.68	777.21	829.74	882.20	934.16	987.26	1039.79	1214.09	1270.69	1323.19	1353.55	6'6"
220	689.53	744.20	798.84	853.50	908.18	962.82	1017.55	1072.18	1257.87	1317.01	1371.72	1403.54	7'8"
240	706.83	763.65	820.49	877.31	934.15	990.95	1047.79	1104.66	1301.62	1363.35	1420.19	1453.48	7'10"
260	724.13	783.15	842.14	901.12	960.08	1019.09	1078.06	1137.07	1345.38	1409.69	1468.69	1503.48	8'6"
280	741.48	802.65	863.76	924.90	986.06	1047.15	1108.34	1169.48	1389.16	1456.06	1517.15	1553.49	9'2"
300	758.79	822.10	885.39	948.71	1012.02	1075.31	1138.63	1201.93	1432.98	1502.36	1565.66	1603.43	9'10"

NOTE: Systems above 2.10m are supplied with heavy duty side profiles 4515/16. Should these be required for systems under 2.10m please add 15% to price in table above.

Price category C

Price Group 3R - Moon

Width	60cm/2'0"	80cm/2'7"	100cm/3'3"	120cm/3'11"	140cm/4'7"	160cm/5'3"	180cm/5'11"	200cm/6'6"	220cm/7'3"	240cm/7'10"	260cm/8'6"	270cm/8'10"	Width
Drop (cm)													Drop ft/ins
60	426.53	466.37	506.14	545.94	585.72	625.58	665.33	705.12	962.81	1009.33	1051.97	1077.18	2'0"
80	449.11	492.80	536.55	580.24	623.95	667.66	711.36	755.06	1024.95	1076.66	1123.22	1151.63	2'7"
100	471.70	519.32	566.91	614.53	662.17	709.78	757.37	804.91	1087.10	1143.99	1194.46	1226.13	3'3"
120	494.29	545.81	597.30	648.82	700.33	751.91	803.40	860.42	1149.24	1211.30	1265.69	1300.57	3'11"
140	516.86	572.29	627.68	683.15	738.54	793.93	849.41	904.84	1211.39	1278.64	1336.90	1375.03	4'7"
160	539.40	598.75	658.09	717.42	776.80	836.05	895.41	954.75	1273.49	1345.94	1408.16	1449.52	5'8"
180	561.97	625.25	688.48	751.71	814.94	878.18	941.48	1004.71	1335.65	1413.27	1479.39	1524.01	5'11"
200	724.66	794.66	864.67	934.70	1004.65	1074.11	1144.70	1214.74	1397.79	1480.61	1550.59	1598.46	6'6"
220	747.24	821.17	895.05	968.96	1042.89	1116.76	1190.73	1264.61	1459.91	1547.93	1621.86	1672.95	7'8"
240	769.80	847.64	925.44	1003.26	1081.09	1158.90	1236.72	1314.59	1522.04	1615.28	1693.10	1747.36	7'10"
260	792.36	874.12	955.84	1037.56	1119.28	1201.02	1282.73	1364.47	1584.18	1682.60	1764.33	1821.87	8'6"
280	814.94	900.60	986.20	1071.84	1157.48	1243.09	1328.75	1414.39	1646.33	1749.97	1835.52	1896.36	9'2"
300	837.51	927.07	1016.59	1106.14	1195.69	1285.23	1374.78	1464.33	1708.49	1817.25	1906.79	1970.80	9'10"

NOTE: Systems above 2.10m are supplied with heavy duty side profiles 4515/16. Should these be required for systems under 2.10m please add 15% to price in table above.

All prices shown exclude VAT



Dim-Out Roller Blind System 4550

Price category C

Price Group 1R - Puma

Width	60cm/2'0"	80cm/2'7"	100cm/3'3"	120cm/3'11"	140cm/4'7"	160cm/5'3"	180cm/5'11"	200cm/6'6"	220cm/7'3"	240cm/7'10"	260cm/8'6"	270cm/8'10"	Width
Drop (cm)													Drop ft/ins
60	931.67	965.06	998.44	1031.82	1065.21	1098.58	1131.93	1165.33	1255.43	1288.83	1322.20	1338.90	2'0"
80	946.04	980.74	1015.37	1050.06	1084.73	1119.45	1154.09	1188.80	1289.49	1324.15	1358.82	1376.14	2'7"
100	960.42	996.37	1032.35	1068.36	1104.35	1140.25	1176.22	1212.20	1323.50	1359.47	1395.42	1413.40	3'3"
120	974.76	1012.07	1049.33	1086.59	1123.83	1161.14	1198.43	1235.68	1357.53	1394.81	1432.00	1450.64	3'11"
140	989.15	1027.74	1066.29	1104.87	1143.44	1181.95	1220.57	1259.12	1391.50	1430.05	1468.62	1487.92	4'7"
160	1003.52	1043.40	1083.26	1123.12	1163.00	1202.83	1242.68	1282.56	1425.52	1465.40	1505.25	1525.20	5'8"
180	1017.89	1059.11	1100.24	1141.39	1182.50	1223.67	1264.86	1306.03	1459.54	1500.66	1541.86	1562.43	5'11"
200	1032.28	1074.72	1117.19	1159.64	1202.11	1244.55	1287.01	1329.45	1493.55	1535.97	1578.42	1599.68	6'6"
220	1046.67	1090.41	1134.16	1177.88	1221.69	1265.41	1309.14	1352.96	1527.56	1571.30	1615.71	1636.96	7'8"
240	1057.52	1106.04	1151.13	1196.14	1241.30	1286.28	1331.30	1376.39	1561.53	1607.90	1652.34	1674.19	7'10"
260	1075.40	1121.75	1168.09	1214.45	1260.78	1307.11	1353.46	1399.80	1595.60	1641.94	1688.26	1711.48	8'6"
280	1089.74	1137.45	1185.08	1232.67	1280.34	1327.99	1375.60	1423.26	1629.62	1677.24	1724.90	1748.70	9'2"
300	1104.13	1153.09	1202.03	1250.95	1299.91	1348.82	1397.80	1446.69	1663.59	1712.55	1761.49	1785.97	9'10"

NOTE: Systems above 2.10m are supplied with heavy duty side profiles 4515/16. Should these be required for systems under 2.10m please add 10% to price in table above.
Integrated Receiver for use with 9940 add £148.95

Price category C

Price Group 2R - Mercurio B

Width	60cm/2'0"	80cm/2'7"	100cm/3'3"	120cm/3'11"	140cm/4'7"	160cm/5'3"	180cm/5'11"	200cm/6'6"	220cm/7'3"	240cm/7'10"	260cm/8'6"	270cm/8'10"	Width
Drop (cm)													Drop ft/ins
60	964.27	998.82	1033.38	1067.93	1102.49	1137.02	1171.54	1206.13	1299.37	1333.93	1368.48	1385.76	2'0"
80	979.16	1015.05	1050.92	1086.81	1122.70	1158.62	1194.48	1230.40	1334.63	1370.49	1406.38	1424.31	2'7"
100	994.04	1031.25	1068.48	1105.76	1142.99	1180.16	1217.39	1254.61	1369.82	1407.04	1444.27	1462.87	3'3"
120	1008.89	1047.49	1086.06	1124.62	1163.17	1201.77	1240.38	1278.94	1405.03	1443.63	1482.12	1501.42	3'11"
140	1023.78	1063.71	1103.60	1143.55	1183.48	1223.31	1263.28	1303.19	1440.20	1480.10	1520.02	1539.99	4'7"
160	1038.63	1079.91	1121.18	1162.43	1203.71	1244.93	1286.18	1327.44	1475.41	1516.70	1557.94	1578.59	5'8"
180	1053.51	1096.18	1138.74	1181.35	1223.89	1266.51	1309.12	1351.74	1510.64	1553.18	1595.82	1617.12	5'11"
200	1068.41	1112.34	1156.30	1200.23	1244.19	1288.12	1332.06	1375.98	1545.82	1589.72	1633.68	1655.67	6'6"
220	1083.28	1128.58	1173.86	1219.10	1264.45	1309.70	1354.97	1400.32	1581.03	1626.29	1672.26	1694.25	7'8"
240	1094.54	1144.75	1191.42	1238.01	1284.76	1331.31	1377.88	1424.56	1616.17	1664.18	1710.18	1732.79	7'10"
260	1113.03	1161.01	1208.97	1256.95	1304.91	1352.86	1400.83	1448.79	1651.45	1699.42	1747.34	1771.37	8'6"
280	1127.87	1177.26	1226.55	1275.81	1325.14	1374.48	1423.75	1473.08	1686.68	1735.94	1785.27	1809.91	9'2"
300	1142.79	1193.45	1244.10	1294.73	1345.42	1396.03	1446.72	1497.31	1721.82	1772.49	1823.14	1848.47	9'10"

Integrated Receiver for use with 9940 add £146.61

Price category C

Price Group 3R - Moon

Width	60cm/2'0"	80cm/2'7"	100cm/3'3"	120cm/3'11"	140cm/4'7"	160cm/5'3"	180cm/5'11"	200cm/6'6"	220cm/7'3"	240cm/7'10"	260cm/8'6"	270cm/8'10"	Width
Drop (cm)													Drop ft/ins
60	988.48	1029.62	1071.86	1114.10	1156.34	1198.57	1240.79	1283.05	1380.17	1426.27	1468.52	1493.47	2'0"
80	1009.93	1056.09	1102.21	1148.38	1194.51	1240.70	1286.79	1332.97	1442.35	1493.61	1539.75	1567.94	2'7"
100	1032.51	1082.54	1132.60	1182.70	1232.76	1282.75	1332.81	1382.85	1504.47	1560.92	1610.98	1642.40	3'3"
120	1055.04	1109.04	1163.01	1216.96	1270.89	1324.88	1378.86	1432.81	1566.62	1628.29	1682.17	1716.86	3'11"
140	1077.63	1135.53	1193.38	1251.25	1309.14	1366.94	1424.86	1482.72	1628.72	1695.56	1753.41	1791.35	4'7"
160	1100.19	1161.98	1223.78	1285.54	1347.33	1409.08	1470.84	1532.62	1690.85	1762.90	1824.67	1865.83	5'8"
180	1122.76	1188.51	1254.17	1319.83	1385.47	1451.18	1516.86	1582.55	1753.01	1830.18	1895.89	1940.28	5'11"
200	1145.35	1214.95	1284.53	1354.11	1423.74	1493.30	1562.87	1632.45	1815.12	1897.51	1967.09	2014.73	6'6"
220	1167.94	1241.44	1314.92	1388.37	1461.94	1535.40	1608.88	1682.43	1877.27	1964.83	2039.01	2089.22	7'8"
240	1186.88	1267.85	1345.30	1422.68	1500.18	1577.54	1654.90	1732.33	1939.35	2033.51	2110.28	2163.66	7'10"
260	1213.06	1294.38	1375.68	1457.02	1538.31	1619.60	1700.91	1782.22	2001.55	2099.52	2180.80	2238.16	8'6"
280	1235.59	1320.89	1406.10	1491.25	1576.49	1661.73	1746.90	1832.13	2063.69	2166.82	2252.05	2312.60	9'2"
300	1258.19	1347.33	1436.47	1525.57	1614.71	1703.80	1792.95	1882.03	2125.78	2234.14	2323.28	2387.08	9'10"

Integrated Receiver for use with 9940 add £146.61

All prices shown exclude VAT



Dim-Out Skylight Roller Blinds

System 4590 – Crank

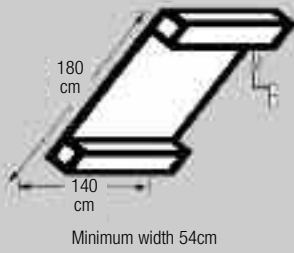

System 4595 – Electric

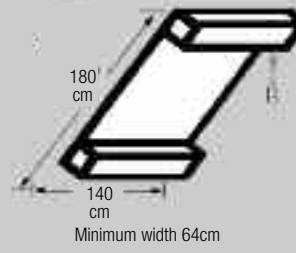

System 4590 – Crank Operated

Price category C

Price Group 1R - Puma

Width	80cm/2'7"	100cm/3'3"	120cm/3'11"	140cm/4'7"	Width
Drop cm					Drop ft/ins
80	923.54	1000.28	1077.08	1153.84	2'7"
100	972.32	1050.40	1128.52	1206.61	3'3"
120	1021.14	1100.54	1179.96	1259.37	3'11"
140	1069.92	1150.67	1231.41	1312.14	4'7"
160	1118.78	1200.78	1282.87	1364.89	5'8"
180	1167.56	1250.90	1334.27	1417.66	5'11"

Price Group 2R - Mercurio B

Width	80cm/2'7"	100cm/3'3"	120cm/3'11"	140cm/4'7"	Width
Drop cm					Drop ft/ins
80	936.57	1016.60	1096.64	1176.66	2'7"
100	988.64	1070.80	1152.98	1235.18	3'3"
120	1040.71	1125.01	1209.31	1293.63	3'11"
140	1092.76	1179.22	1265.65	1352.09	4'7"
160	1144.87	1233.40	1322.01	1410.56	5'8"
180	1196.91	1287.60	1378.33	1469.03	5'11"

Price Group 3R - Moon

Width	80cm/2'7"	100cm/3'3"	120cm/3'11"	140cm/4'7"	Width
Drop cm					Drop ft/ins
80	964.56	1051.58	1138.63	1225.66	2'7"
100	1023.61	1114.53	1205.47	1296.39	3'3"
120	1082.68	1177.50	1272.30	1367.09	3'11"
140	1141.73	1240.44	1339.13	1437.82	4'7"
160	1200.84	1303.38	1405.96	1508.53	5'8"
180	1259.90	1366.33	1472.78	1579.24	5'11"

System 4595 – Electrically Operated

Price category C

Price Group 1R - Puma

Width	80cm/2'7"	100cm/3'3"	120cm/3'11"	140cm/4'7"	Width
Drop cm					Drop ft/ins
80	1200.89	1276.12	1351.40	1426.58	2'7"
100	1249.91	1326.42	1402.94	1479.43	3'3"
120	1298.95	1376.70	1454.48	1532.27	3'11"
140	1347.95	1427.07	1506.08	1585.07	4'7"
160	1396.99	1477.31	1557.63	1637.96	5'8"
180	1446.03	1527.60	1609.19	1690.80	5'11"

Price Group 2R - Mercurio B

Width	80cm/2'7"	100cm/3'3"	120cm/3'11"	140cm/4'7"	Width
Drop cm					Drop ft/ins
80	1242.91	1320.78	1398.71	1476.51	2'7"
100	1293.66	1372.85	1452.04	1531.21	3'3"
120	1344.43	1424.88	1505.40	1585.90	3'11"
140	1395.12	1477.02	1558.79	1640.55	4'7"
160	1445.89	1529.00	1612.15	1695.29	5'8"
180	1496.64	1581.07	1665.52	1749.98	5'11"

Price Group 3R - Moon

Width	80cm/2'7"	100cm/3'3"	120cm/3'11"	140cm/4'7"	Width
Drop cm					Drop ft/ins
80	1283.95	1372.07	1460.26	1548.33	2'7"
100	1344.95	1436.96	1528.99	1620.98	3'3"
120	1405.97	1501.83	1597.72	1693.62	3'11"
140	1466.94	1566.78	1666.52	1766.21	4'7"
160	1527.95	1631.60	1735.25	1838.92	5'8"
180	1588.97	1696.48	1804.00	1911.56	5'11"

NOTE: Our Skylight Roller blind systems are supplied ready assembled in an 80mm x 20mm aluminium framework for easy fitting. Integrated Receiver for use with 9940 add £148.95

All prices shown exclude VAT



Venetian Blinds

Venetian Blind Slat Information

Aluminium Slats

Price Group 1

Slat Reference	Slat Width (mm)	Slat Description
603	16	Natural Alu
612	16	Off White
613	16	Clear White
615	16	White

Slat Reference	Slat Width (mm)	Slat Description
648	16	Light Grey
649	16	Light Grey
650	16	Magnolia
706	25	Natural Alu

Slat Reference	Slat Width (mm)	Slat Description
716	25	Off White
718	25	Clear White
720	25	White
758	25	Light Grey

Slat Reference	Slat Width (mm)	Slat Description
759	25	Light Grey
761	25	Magnolia

Price Group 2

Slat Reference	Slat Width (mm)	Slat Description
601	16	Polished Alu
602	16	TRP Natural Silver
604	16	Bright Silver
609	16	Natural Silver
610	16	Natural Silver Matt
611	16	Light Ash
614	16	Pearl China White
616	16	Light Grey
617	16	Grey Flannel
618	16	Metal Grey

Slat Reference	Slat Width (mm)	Slat Description
619	16	Gloss Black
620	16	Black
624	16	Turkey Blue
651	16	Magnolia
657	16	Fire Dragon
658	16	Glossy Red
659	16	Spectrum Red
660	16	Garnet Red
703	25	Polished Alu
704	25	TRP Natural Silver

Slat Reference	Slat Width (mm)	Slat Description
705	25	Alu Perforated
707	25	Bright Silver
712	25	Natural Silver
713	25	Natural Silver Matt
714	25	Light Ash
715	25	White Perforated
719	25	Pearl China White
723	25	Light Grey
724	25	Grey Flannel
725	25	Metal Grey

Slat Reference	Slat Width (mm)	Slat Description
726	25	Gloss Black
729	25	Black
733	25	Turkey Blue
760	25	Magnolia Perforated
762	25	Magnolia
770	25	Fire Dragon
771	25	Glossy Red
772	25	Spectrum Red
773	25	Garnet Red

Price Group 3

Slat Reference	Slat Width (mm)	Slat Description
605	16	Bright Gold
606	16	Caribou
607	16	Bright Bronze
608	16	Aluminium Gris
621	16	Black Tie
622	16	Indigo
623	16	Admiral
625	16	Mount Baker
626	16	Morning Glory
627	16	Universe Blue
628	16	Pearl Gulf Blue
629	16	Fishing Blue
630	16	Greek Holiday
631	16	Light Laguna
632	16	Pearl Jade
633	16	Riverbend
634	16	Green Mint
635	16	Hunter Green
636	16	Chameleon Green
637	16	Green Aspen
638	16	Weeping Green
639	16	Grass Snake

Slat Reference	Slat Width (mm)	Slat Description
640	16	Absinthe
641	16	Aztec
642	16	Saffron
643	16	Naples Cream
644	16	Daffodil
645	16	Maize Yellow
646	16	Light Banana
647	16	Beaverwood
652	16	Fawn
653	16	Spun Gold
654	16	US Beige
655	16	Mud Pie
656	16	Dark Beige
661	16	EL Morocco
701	25	Foil Mirror Silver
702	25	Alu Perforated
708	25	Bright Gold
709	25	Caribou
710	25	Bright Bronze
711	25	Aluminium Gris
717	25	Off White
721	25	White

Slat Reference	Slat Width (mm)	Slat Description
722	25	Grey Perforated
727	25	Black Perforated
728	25	Black
730	25	Black Tie
731	25	Indigo
732	25	Admiral
734	25	Mount Baker
735	25	Morning Glory
736	25	Universe Blue
737	25	Pearl Gulf Blue
738	25	Fishing Blue
739	25	Greek Holiday
740	25	Light Laguna
741	25	Emerald Ice
742	25	Pearl Jade
743	25	Riverbend
744	25	Green Mint
745	25	Hunter Green
746	25	Chameleon Green
747	25	Green Aspen
748	25	Weeping Green
749	25	Grass Snake

Slat Reference	Slat Width (mm)	Slat Description
750	25	Absinthe
751	25	Aztec
752	25	Saffron
753	25	Naples Cream
754	25	Daffodil
755	25	Maize Yellow
756	25	Light Banana
757	25	Beaverwood
763	25	Fawn
764	25	Fawn
765	25	Spun Gold
766	25	US Beige
767	25	Mud Pie
768	25	Dark Beige
769	25	Diamond Mine
774	25	EL Morocco
775	25	Woodgrain Beech
776	25	Woodgrain Dark Oak
777	25	Woodgrain Abbey

50mm Slats For pricing see system tables

Slat Description	Slat Width (mm)
Standard Colours	
Stark	25 and 50
Alpine	25 and 50
Soft White	25 and 50
Holstein	25 and 50
Cloud	25 and 50
Eggshell	25 and 50
Sandwash	25 and 50
Alabaster	25 and 50
Linen	25 and 50
Natural	25 and 50

Slat Description	Slat Width (mm)
Sugar Maple	25 and 50
Light Oak	25 and 50
Golden Oak	25 and 50
Pecan	25 and 50
New Walnut	25 and 50
New Wenge	25 and 50
Yarrin	25 and 50
Premium Colours – Please uplift pricing for Systems 8900/8950 by 20%.	
Acid	50
Astro	50

Slat Description	Slat Width (mm)
Caroba	50
Cassia	50
Cirrus	50
Electric	50
Envy	50
Exquis	50
Feline	50
Fizz	50
Gravity	50
Halti	50
Icon	50

Slat Description	Slat Width (mm)
Isiro	50
Koli	50
Koto	50
Lulu	50
Matumi	50
Orali	50
Pardo	50
Poison	50
Vamp	50
Zura	50

Note: Premium Colours are supplied with white headbox and accessories as standard. Silver, bronze and vanilla are also available on request.



Venetian Blinds

System 8100 (16mm)

Mono control Venetian Blind System.
 Slats 16mm.
 Maximum System Width: 2.5m
 Minimum System Width: 28cm
 Maximum System Drop: 2.5m
 Maximum Surface Area: 4m²

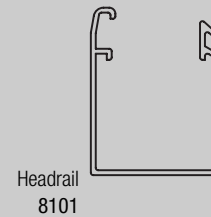
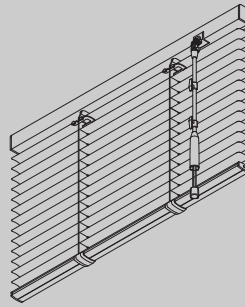

The prices in the tables below comprise the complete system made-to-measure with 16mm slats ready to hang. If sizes lie between the measurements shown, the price for the next size larger will apply. White control wands as standard (other colours available) will be on the right-hand side. The following wand sizes are available 225mm, 385mm, 585mm, 785mm, 985mm, 1185mm, 1385mm, 1585mm and 1800mm. For side guided version please add 20% to prices below.

Price Group 1

Price Category C

Width ► Drop ▼ cm	60cm 2'0"	80cm 2'7"	100cm 3'3"	120cm 3'11"	140cm 4'7"	160cm 5'3"	180cm 5'11"	200cm 6'6"	220cm 7'3"	240cm 7'10"	260cm 8'6"	280cm 9'2"	300cm 9'10"	◀ Width Drop ft.ins.
100	187.39	200.05	212.75	225.39	238.05	250.70	263.36	276.02	288.71	301.37	314.01	326.66	339.32	3'3"
120	190.83	204.60	218.45	232.22	246.03	259.80	273.62	287.46	301.22	315.05	328.81	342.62	356.39	3'11"
140	194.25	209.18	224.16	239.08	254.01	268.97	283.90	298.82	313.80	328.73	343.65	358.57	373.54	4'7"
160	197.81	213.95	230.07	246.24	262.40	278.54	294.66	310.80	326.91	343.04	359.22	375.34	391.47	5'3"
180	201.29	218.54	235.82	253.06	270.34	287.64	304.91	322.15	339.45	356.73	374.01			5'11"
200	204.86	223.29	241.79	260.27	278.75	297.25	315.68	334.16	352.66	371.09				6'6"
220	208.24	227.84	247.49	267.09	286.74	306.33	325.94	345.58	365.19					7'3"
240	211.68	232.43	253.19	273.96	294.69	318.89	336.19	356.94						7'10"
260	215.27	237.23	259.16	281.12	303.08	325.03	347.00							8'6"
280	218.70	241.82	264.85	287.98	311.06	334.12								9'2"
300	222.27	246.58	270.86	295.15	319.45	343.74								9'10"

Price Group 2

Price Category C

Width ► Drop ▼ cm	60cm 2'0"	80cm 2'7"	100cm 3'3"	120cm 3'11"	140cm 4'7"	160cm 5'3"	180cm 5'11"	200cm 6'6"	220cm 7'3"	240cm 7'10"	260cm 8'6"	280cm 9'2"	300cm 9'10"	◀ Width Drop ft.ins.
100	217.03	236.82	256.62	276.40	296.22	316.03	335.84	355.62	375.44	395.25	415.07	434.89	454.65	3'3"
120	223.73	245.81	267.85	289.91	311.95	334.05	356.08	378.13	400.19	422.27	444.28	466.32	488.37	3'11"
140	230.45	254.78	279.09	303.38	327.69	352.00	376.28	400.61	424.94	449.21	473.48	497.81	522.12	4'7"
160	237.57	264.26	290.94	317.60	344.29	370.98	397.60	424.33	450.96	477.69	504.32	531.05	557.68	5'3"
180	244.36	273.27	302.16	331.08	360.03	388.94	417.86	446.75	475.76	504.67	533.57			5'11"
200	251.47	282.76	314.06	345.33	376.62	407.94	439.20	470.52	501.79	533.11				6'6"
220	258.20	291.75	325.29	358.84	392.39	425.91	459.45	492.99	526.55					7'3"
240	264.99	300.71	336.53	372.30	408.12	443.88	479.69	515.48						7'10"
260	272.05	310.24	348.37	386.54	424.72	462.85	501.07							8'6"
280	278.79	319.20	359.60	400.00	440.42	480.87								9'2"
300	285.92	328.67	371.50	400.05	457.05	499.82								9'10"

Price Group 3

Price Category C

Width ► Drop ▼ cm	60cm 2'0"	80cm 2'7"	100cm 3'3"	120cm 3'11"	140cm 4'7"	160cm 5'3"	180cm 5'11"	200cm 6'6"	220cm 7'3"	240cm 7'10"	260cm 8'6"	280cm 9'2"	300cm 9'10"	◀ Width Drop ft.ins.
100	249.70	281.16	312.55	343.99	375.44	406.87	438.31	469.75	501.19	532.62	564.03	595.47	626.91	3'3"
120	255.54	288.97	322.33	355.74	389.07	422.50	455.90	489.28	522.64	556.05	589.43	622.83	656.15	3'11"
140	261.42	296.77	332.11	367.41	402.80	438.10	473.48	508.79	544.14	579.48	614.82	650.12	685.49	4'7"
160	267.60	304.96	342.35	379.80	417.17	454.56	491.97	529.37	566.78	604.13	641.57	678.93	716.34	5'3"
180	273.43	312.77	352.15	391.47	430.85	470.18	509.52	548.89	588.22	627.55	666.97			5'11"
200	279.61	321.01	362.44	403.83	445.26	486.65	528.03	569.47	610.86	652.30				6'6"
220	285.49	328.81	372.22	415.53	458.90	502.26	545.62	588.98	632.36					7'3"
240	291.33	336.61	381.95	427.29	472.57	517.93	563.21	608.50						7'10"
260	297.51	344.84	392.24	439.59	487.00	534.34	581.74							8'6"
280	303.38	352.66	401.98	451.30	500.63	549.96								9'2"
300	309.55	360.89	412.29	463.70	515.04	566.44								9'10"

N.B. When ordering System 8100, orders MUST be accompanied by a signed measure sheet.

All prices shown exclude VAT



Venetian Blinds

System 8110 (16mm)

Mono control Venetian Blind System.
 Slats 16mm.
 Maximum System Width: 2.5m
 Minimum System Width: 28cm
 Maximum System Drop: 2.5m
 Maximum Surface Area: 5m²

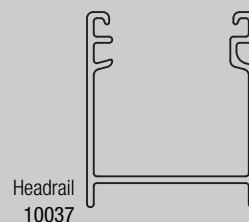
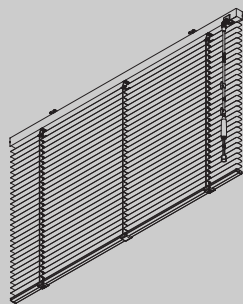

The prices in the tables below comprise the complete system made-to-measure with 16mm slats ready to hang. If sizes lie between the measurements shown, the price for the next size larger will apply. White control wands as standard (other colours available) will be on the right-hand side. The following wand sizes are available 225mm, 385mm, 585mm, 785mm, 985mm, 1185mm, 1385mm, 1585mm and 1800mm.

Price Group 1

Price Category C

Width Drop cm	60cm 2'0"	80cm 2'7"	100cm 3'3"	120cm 3'11"	140cm 4'7"	160cm 5'3"	180cm 5'11"	200cm 6'6"	220cm 7'3"	240cm 7'10"	250cm 8'6"	Width Drop ft.ins.
60	131.05	143.22	155.40	167.60	179.78	191.96	204.15	216.33	228.51	240.71	246.79	2'0"
80	134.96	148.41	161.86	175.31	188.76	202.21	215.66	229.10	242.54	256.01	262.72	2'7"
100	138.87	153.58	168.30	183.03	197.73	212.45	227.16	241.87	256.59	271.31	278.66	3'3"
120	142.80	158.77	174.75	190.73	206.71	222.70	238.67	254.64	270.62	286.60	294.60	3'11"
140	146.70	163.95	181.19	198.43	215.68	232.93	250.18	267.43	284.66	301.92	310.55	4'7"
160	150.62	169.12	187.64	206.14	224.65	243.17	261.68	280.20	298.72	317.22	326.48	5'3"
180	154.53	174.31	194.09	213.85	233.63	253.42	273.19	292.96	312.75	332.53	342.40	5'11"
200	158.43	179.49	200.53	221.57	242.62	263.66	284.70	305.75	326.79	347.83	358.35	6'6"
220	162.36	184.66	206.96	229.28	251.58	273.90	296.22	318.52	340.84			7'3"
240	166.27	189.84	213.43	236.98	260.58	284.14	307.71	331.29				7'10"
260	168.23	192.43	216.64	240.84	265.06	289.27	313.46	337.68				8'6"

Price Group 2

Price Category C

Width Drop cm	60cm 2'0"	80cm 2'7"	100cm 3'3"	120cm 3'11"	140cm 4'7"	160cm 5'3"	180cm 5'11"	200cm 6'6"	220cm 7'3"	240cm 7'10"	250cm 8'6"	Width Drop ft.ins.
60	135.36	148.97	166.02	176.21	189.83	203.46	217.07	230.68	244.32	257.93	264.74	2'0"
80	140.70	156.07	171.42	186.78	202.17	217.53	232.89	248.25	263.62	278.98	286.67	2'7"
100	146.06	163.16	180.28	197.38	214.49	231.61	248.70	265.82	282.92	300.03	308.59	3'3"
120	151.40	170.25	189.12	207.96	226.81	245.68	264.52	283.37	302.23	321.08	330.51	3'11"
140	156.75	177.36	197.96	218.55	239.14	259.74	280.34	300.92	321.52	342.12	352.44	4'7"
160	162.10	184.45	206.79	229.12	251.47	273.80	296.16	318.50	340.85	363.18	374.34	5'3"
180	167.46	191.54	215.63	239.71	263.79	287.89	311.97	336.05	360.14	384.23	396.28	5'11"
200	172.80	198.64	224.47	250.29	276.12	301.95	327.79	353.62	379.45	405.27	418.20	6'6"
220	178.16	205.73	233.31	260.89	288.45	316.03	343.61	371.18	398.75			7'3"
240	183.49	212.82	242.14	271.46	300.78	330.09	359.42	388.72				7'10"
260	186.17	216.36	246.56	276.75	306.95	337.12	367.33	397.51				8'6"

Price Group 3

Price Category C

Width Drop cm	60cm 2'0"	80cm 2'7"	100cm 3'3"	120cm 3'11"	140cm 4'7"	160cm 5'3"	180cm 5'11"	200cm 6'6"	220cm 7'3"	240cm 7'10"	250cm 8'6"	Width Drop ft.ins.
60	145.63	160.79	175.95	191.11	206.26	221.43	236.58	251.74	266.90	282.06	289.64	2'0"
80	152.03	169.28	186.51	203.78	221.01	238.26	255.49	272.75	290.00	307.25	315.86	2'7"
100	158.41	177.76	197.09	216.42	235.77	255.10	274.43	293.77	313.10	332.44	342.10	3'3"
120	164.80	186.23	207.65	229.09	250.51	271.93	293.36	314.78	336.21	357.64	368.35	3'11"
140	171.21	194.72	218.23	241.74	265.26	288.77	312.29	335.80	359.32	382.83	394.59	4'7"
160	177.58	203.21	228.79	254.40	280.01	305.61	331.22	356.82	382.41	408.02	420.83	5'3"
180	183.98	211.68	239.37	267.06	294.74	322.44	350.13	377.82	405.52	433.22	447.06	5'11"
200	190.36	220.16	249.94	279.72	309.50	339.28	369.07	398.85	428.63	458.41	473.31	6'6"
220	196.76	228.64	260.50	292.38	324.25	356.11	387.99	419.86	451.74			7'3"
240	195.16	237.13	271.09	305.04	339.00	372.96	406.91	440.87				7'10"
260	206.35	241.36	276.37	311.36	346.37	381.38	416.38	451.37				8'6"

All prices shown exclude VAT



Venetian Blinds

System 8110PC (25mm)

Mono control Venetian Blind System.
 Slats 25mm.
 Maximum System Width: 3m
 Minimum System Width: 28cm
 Maximum System Drop: 5m
 Maximum Surface Area: 7m²

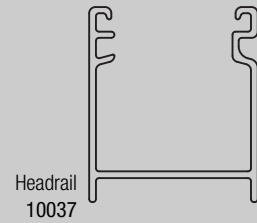
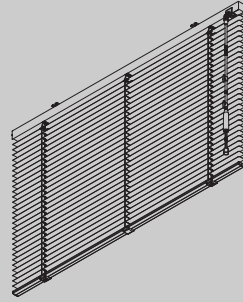

The prices in the tables below comprise the complete system made-to-measure with 25mm slats ready to hang. If sizes lie between the measurements shown, the price for the next size larger will apply. White control wands as standard (other colours available) will be on the right-hand side. The following wand sizes are available 225mm, 385mm, 585mm, 785mm, 985mm, 1185mm, 1385mm, 1585mm and 1800mm.

Price Group 1

Price Category C

Width Drop cm	60cm 2'0"	80cm 2'7"	100cm 3'3"	120cm 3'11"	140cm 4'7"	160cm 5'3"	180cm 5'11"	200cm 6'6"	220cm 7'3"	240cm 7'10"	260cm 8'6"	280cm 9'2"	300cm 9'10"	Width Drop ft.ins.
60	132.87	145.58	158.30	171.01	183.72	196.43	209.14	221.86	234.57	247.29	260.01	272.72	285.43	2'0"
80	136.97	150.97	164.98	178.97	192.97	206.97	220.98	234.97	248.98	262.98	276.99	291.00	304.99	2'7"
100	141.06	156.35	171.64	186.95	202.23	217.53	232.80	248.09	263.38	278.67	293.96	309.26	324.55	3'3"
120	145.15	161.73	178.31	194.90	211.48	228.05	244.64	261.22	277.79	294.35	310.94	327.52	344.11	3'11"
140	149.25	167.13	184.99	202.86	220.73	238.59	256.46	274.33	292.19	310.06	327.92	345.80	363.65	4'7"
160	153.36	172.51	191.66	210.81	229.98	249.13	268.28	287.44	306.60	325.75	344.90	364.05	383.22	5'3"
180	157.46	177.89	198.34	218.79	239.22	259.66	280.12	300.55	321.00	341.46	361.88	382.33	402.76	5'11"
200	161.56	183.28	205.01	226.74	248.49	270.21	291.94	313.67	335.40	357.14	378.86	400.60	422.32	6'6"
220	165.65	188.65	211.69	234.71	257.73	280.75	303.76	326.79	349.80	372.83	395.84	418.86	441.88	7'3"
240	169.74	194.06	218.36	242.67	266.98	291.28	315.58	339.90	364.20	388.53	412.81	437.13	461.44	7'10"
260	173.84	199.44	225.03	250.64	276.23	301.81	327.43	353.01	378.61	404.20	429.79	455.40		8'6"
280	177.93	204.83	231.71	258.60	285.47	312.35	339.24	366.12	393.02	419.89	446.77			9'2"
300	182.04	210.20	238.38	266.55	294.71	322.91	351.08	379.24	407.42	435.59				9'10"
320	186.14	215.61	245.06	274.51	303.98	333.44	362.90	392.35	421.82					10'6"
340	190.24	220.98	251.74	282.49	313.23	343.98	374.71	405.48						11'2"
360	194.35	226.37	258.41	290.44	322.47	354.53	386.55	418.59						11'10"
380	198.43	231.75	265.08	298.41	331.73	365.04	398.38							12'6"
400	202.53	237.15	271.74	306.36	340.97	375.59	410.20							13'1"
420	206.62	242.52	278.42	314.34	350.22	386.13								13'9"
440	210.73	247.92	285.10	322.29	359.48	396.67								14'5"
460	214.82	253.29	291.78	330.25	368.73									15'1"
480	218.93	258.69	298.45	338.21	377.97									15'9"
500	223.04	264.07	305.13	346.18	387.24									16'5"

Price Group 2

Price Category C

Width Drop cm	60cm 2'0"	80cm 2'7"	100cm 3'3"	120cm 3'11"	140cm 4'7"	160cm 5'3"	180cm 5'11"	200cm 6'6"	220cm 7'3"	240cm 7'10"	260cm 8'6"	280cm 9'2"	300cm 9'10"	Width Drop ft.ins.
60	137.31	151.49	165.71	179.89	194.09	208.28	222.48	236.66	250.86	265.06	279.25	293.44	307.63	2'0"
80	142.88	158.86	174.83	190.82	206.79	222.77	238.74	254.71	270.68	286.67	302.64	318.62	334.60	2'7"
100	148.46	166.22	183.98	201.73	219.50	237.25	255.00	272.75	290.50	308.28	326.03	343.78	361.54	3'3"
120	154.04	173.58	193.11	212.65	232.20	251.74	271.26	290.80	310.35	329.89	349.43	368.97	388.51	3'11"
140	159.62	180.94	202.25	223.57	244.90	266.21	287.52	308.86	330.18	351.49	372.82	394.14	415.45	4'7"
160	165.19	188.29	211.40	234.50	257.60	280.71	303.80	326.90	350.01	373.12	396.20	419.31	442.42	5'3"
180	170.76	195.65	220.54	245.42	270.29	295.19	320.06	344.95	369.84	394.72	419.60	444.48	469.37	5'11"
200	176.36	203.01	229.69	256.35	283.00	309.68	336.34	363.01	389.67	405.13	443.00	469.66	496.32	6'6"
220	181.93	210.38	238.82	267.26	295.70	324.16	352.60	381.05	409.50	437.94	466.38	494.83	523.28	7'3"
240	187.51	217.73	247.96	278.20	308.41	338.65	368.87	399.10	429.32	459.57	489.79	520.01	550.24	7'10"
260	193.08	225.10	257.10	289.11	321.11	353.13	385.13	417.15	449.15	481.16	513.17	545.18		8'6"
280	198.67	232.45	266.24	300.04	333.82	367.63	401.40	435.21	468.98	502.77	536.56			9'2"
300	204.24	239.80	275.38	310.95	346.52	382.09	417.67	453.24	488.81	524.38				9'10"
320	209.82	247.18	284.54	321.89	359.22	396.57	433.93	471.29	508.63					10'6"
340	215.39	254.53	293.66	332.80	371.93	411.06	450.20	489.34						11'2"
360	220.97	261.89	302.80	343.71	384.63	425.54	466.47	507.38						11'10"
380	226.55	269.24	311.95	354.65	397.35	440.04	482.74							12'6"
400	232.12	276.61	321.08	365.56	410.05	454.52	498.99							13'1"
420	237.71	283.96	330.23	376.50	422.75	469.00								13'9"
440	243.29	291.33	339.36	387.39	435.45	483.49								14'5"
460	248.87	298.69	348.51	398.33	448.16									15'1"
480	254.43	306.04	357.65	409.25	460.85									15'9"
500	260.02	313.41	366.79	420.18	473.56									16'5"

All prices shown exclude VAT



Venetian Blinds

System 8110PC (25mm)

Mono control Venetian Blind System.
 Slats 25mm.
 Maximum System Width: 3m
 Minimum System Width: 28cm
 Maximum System Drop: 5m
 Maximum Surface Area: 7m²

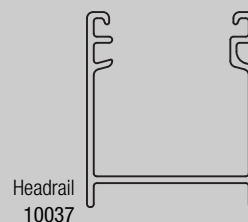
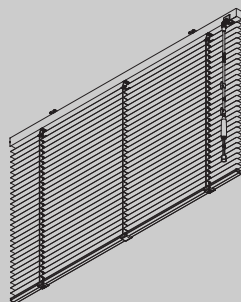

The prices in the table below comprise the complete system made-to-measure with 25mm slats ready to hang. If sizes lie between the measurements shown, the price for the next size larger will apply. White control wands as standard (other colours available) will be on the right-hand side. The following wand sizes are available 225mm, 385mm, 585mm, 785mm, 985mm, 1185mm, 1385mm, 1585mm and 1800mm.

Price Group 3 – 25mm slat size

Price Category C

Width ► Drop ▼ cm	60cm 2'0"	80cm 2'7"	100cm 3'3"	120cm 3'11"	140cm 4'7"	160cm 5'3"	180cm 5'11"	200cm 6'6"	220cm 7'3"	240cm 7'10"	260cm 8'6"	280cm 9'2"	300cm 9'10"	◀ Width Drop ft.ins.
60	149.97	168.36	186.77	205.20	223.60	242.01	260.43	278.85	297.27	315.67	334.08	352.50	370.91	2'0"
80	159.76	181.35	202.96	224.55	246.14	267.76	289.35	310.95	332.55	354.14	375.75	397.36	418.95	2'7"
100	169.55	194.35	219.13	243.91	268.71	293.49	318.27	343.05	367.84	392.63	417.41	442.20	466.99	3'3"
120	179.34	207.32	235.29	263.26	291.25	319.22	347.19	375.17	403.15	431.12	459.08	487.07	515.04	3'11"
140	189.15	220.31	251.47	282.62	313.79	344.95	376.13	407.28	438.45	469.59	500.76	531.91	563.08	4'7"
160	198.94	233.30	267.64	302.00	336.34	370.69	405.02	439.38	473.73	508.08	542.44	576.78	611.13	5'3"
180	208.74	246.27	283.82	321.35	358.88	396.42	433.95	471.48	509.02	546.56	584.10	621.64	659.17	5'11"
200	218.52	259.26	299.98	340.69	381.43	422.15	462.88	503.61	544.31	585.04	625.78	666.49	707.23	6'6"
220	228.33	272.24	316.15	360.06	403.99	447.90	491.79	535.70	579.61	623.53	667.44	711.36	755.27	7'3"
240	238.12	285.23	332.33	379.42	426.51	473.61	520.72	567.82	614.91	662.01	709.10	756.22	803.31	7'10"
260	247.92	298.20	348.48	398.79	449.06	499.34	549.64	599.92	650.21	700.50	750.78	801.06		8'6"
280	257.72	311.18	364.66	418.14	471.61	525.08	578.55	632.02	685.50	738.98	792.45			9'2"
300	267.51	324.17	380.83	437.49	494.22	550.81	607.47	664.14	720.79	777.47				9'10"
320	277.30	337.14	397.00	456.85	516.70	576.54	636.41	696.25	756.09					10'6"
340	287.10	350.13	413.16	476.21	539.25	602.27	665.31	728.35						11'2"
360	296.90	363.12	429.35	495.56	561.80	628.02	694.24	760.46						11'10"
380	306.69	376.11	445.51	514.93	584.33	653.75	723.15							12'6"
400	316.49	389.09	461.69	534.29	606.88	679.47	752.09							13'1"
420	326.28	402.07	477.85	553.65	629.42	705.21								13'9"
440	336.07	415.06	494.02	572.99	651.98	730.94								14'5"
460	345.87	428.04	510.20	592.36	674.51									15'1"
480	355.67	441.03	526.36	611.72	697.05									15'9"
500	365.46	454.00	542.54	631.08	719.62									16'5"

All prices shown exclude VAT



Venetian Blinds

System 8250 (16mm)

Electrically operated Venetian Blind System.

System with 24v motor 8060.

Maximum System Width: 300cm

Minimum System Width: 65cm*

Maximum System Drop: 340cm

Maximum Surface Area: 5m²

* Please refer to Catalogue pages

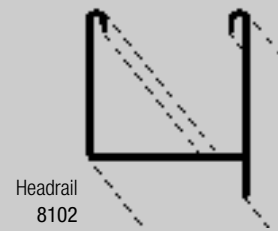
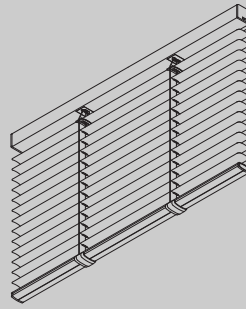

The prices in the tables below and on the following page comprise the complete system made-to-measure with 16mm and 25mm slats ready to hang with universal snap bracket 8005. If sizes lie between the measurements shown, the price for the next size larger will apply. For multicoloured blinds add 20% to prices below for each colour. For side-guided/sloping version add 20% to prices below.

Price Group 1

Price Category C

Width Drop cm	60cm 2'0"	80cm 2'7"	100cm 3'3"	120cm 3'11"	140cm 4'7"	160cm 5'3"	180cm 5'11"	200cm 6'6"	220cm 7'3"	240cm 7'10"	260cm 8'6"	280cm 9'2"	300cm 9'10"	Width Drop ft.ins.
60	503.11	528.39	553.72	579.02	604.33	629.68	654.99	680.29	705.62	730.94	756.26	781.56	806.89	2'0"
80	507.74	534.37	561.00	587.59	614.23	640.86	667.45	694.07	720.70	747.29	773.94	800.55	827.16	2'7"
100	512.43	540.34	568.27	596.16	624.11	652.01	679.93	707.87	735.77	763.70	791.60	819.51	847.43	3'3"
120	517.09	546.31	575.51	604.73	633.97	663.18	692.42	721.62	750.82	780.06	809.25	838.47	867.71	3'11"
140	521.77	552.29	582.78	613.33	643.83	674.35	704.85	735.39	765.92	796.43	826.93	857.46	887.97	4'7"
160	526.45	558.27	590.09	621.85	653.71	685.54	717.36	749.15	780.98	812.79	844.62	876.43	908.24	5'3"
180	531.10	564.20	597.35	630.45	663.60	696.70	729.80	762.93	796.06	829.18	862.29			5'11"
200	535.78	570.20	604.62	639.02	673.46	707.88	742.29	776.70	811.13	845.55				6'6"
220		576.16	611.87	647.62	683.31	719.04	754.75	790.46	826.19					7'3"
240		582.14	619.17	656.18	693.18	730.19	767.25	804.27						7'10"
260		588.11	626.43	664.74	703.07	741.38	779.71							8'6"
280		594.09	633.70	673.32	712.92	752.56								9'2"
300		600.05	640.98	681.88	722.80	763.75								9'10"
320		606.00	648.24	690.45	732.67									10'6"
340		612.00	655.49	699.01	742.57									11'2"

Price Group 2

Price Category C

Width Drop cm	60cm 2'0"	80cm 2'7"	100cm 3'3"	120cm 3'11"	140cm 4'7"	160cm 5'3"	180cm 5'11"	200cm 6'6"	220cm 7'3"	240cm 7'10"	260cm 8'6"	280cm 9'2"	300cm 9'10"	Width Drop ft.ins.
60	509.34	536.75	564.12	591.52	618.93	646.31	673.71	701.10	728.53	755.91	783.29	810.68	838.08	2'0"
80	514.78	543.75	572.69	601.64	630.60	659.58	688.53	717.48	746.44	775.39	804.36	833.30	862.26	2'7"
100	520.22	550.75	581.29	611.78	642.32	672.82	703.33	733.86	764.36	794.89	825.40	855.91	886.46	3'3"
120	525.68	557.77	589.83	621.89	654.00	686.08	718.15	750.21	782.27	814.37	846.46	878.52	910.62	3'11"
140	531.13	564.78	598.41	632.03	665.67	699.29	732.94	766.60	800.25	833.89	867.50	901.15	934.79	4'7"
160	536.58	571.77	606.98	642.16	677.39	712.57	747.77	782.98	818.17	853.38	888.57	923.76	958.96	5'3"
180	542.04	578.78	615.55	652.31	689.07	725.82	762.58	799.34	836.09	872.88	909.61			5'11"
200	547.47	585.80	624.12	662.44	700.75	739.07	777.39	815.70	854.02	892.36				6'6"
220		592.81	632.68	672.56	712.46	752.31	792.20	832.09	871.99					7'3"
240		599.82	641.27	682.70	724.14	765.57	807.01	848.47						7'10"
260		606.85	649.83	692.82	735.84	778.82	821.83							8'6"
280		613.85	658.42	703.00	747.53	792.09								9'2"
300		620.86	666.97	713.12	759.21	805.34								9'10"
320		627.87	675.57	723.21	770.90									10'6"
340		634.88	684.13	733.36	782.61									11'2"

Price Group 3

Price Category C

Width Drop cm	60cm 2'0"	80cm 2'7"	100cm 3'3"	120cm 3'11"	140cm 4'7"	160cm 5'3"	180cm 5'11"	200cm 6'6"	220cm 7'3"	240cm 7'10"	260cm 8'6"	280cm 9'2"	300cm 9'10"	Width Drop ft.ins.
60	529.72	558.23	586.69	615.18	643.69	672.17	700.66	729.14	757.68	786.14	814.63	843.11	871.61	2'0"
80	535.37	565.48	595.60	625.70	655.83	685.96	716.09	746.17	776.29	806.42	836.54	866.64	896.77	2'7"
100	541.03	572.80	604.55	636.25	668.01	699.74	731.45	763.21	794.93	826.69	858.41	890.15	921.92	3'3"
120	546.70	580.08	613.43	646.77	680.16	713.53	746.86	780.23	813.57	846.96	880.31	913.65	947.04	3'11"
140	552.37	587.36	622.35	657.33	692.31	727.28	762.26	797.27	832.25	867.24	902.19	937.19	972.19	4'7"
160	558.03	594.65	631.27	667.85	704.48	741.09	777.67	814.30	850.89	887.51	924.12	960.72	997.32	5'3"
180	563.73	601.93	640.17	678.39	716.62	754.88	793.10	831.32	869.54	907.79	946.00			5'11"
200	569.36	609.23	649.06	688.96	728.79	768.65	808.49	848.32	888.18	928.06				6'6"
220		616.52	657.98	699.47	740.94	782.42	823.89	865.36	906.86					7'3"
240		623.82	666.93	710.02	753.12	796.21	839.29	882.41						7'10"
260		631.11	675.80	720.54	765.26	809.97	854.70							8'6"
280		638.42	684.74	731.10	777.42	823.76								9'2"
300		645.70	693.64	741.63	789.60	837.54								9'10"
320		652.99	702.58	752.14	801.73									10'6"
340		660.27	711.49	762.69	813.93									11'2"

Supplied with standard rocker switch. Programmable rocker switch (0937) available as an optional accessory.

All prices shown exclude VAT



Venetian Blinds

System 8250 (25mm)

Electrically operated Venetian Blind System.
System with 24v motor 8060.

Maximum System Width: 300cm
Minimum System Width: 65cm*
Maximum System Drop: 340cm
Maximum Surface Area: 5m²

* Please refer to Catalogue pages

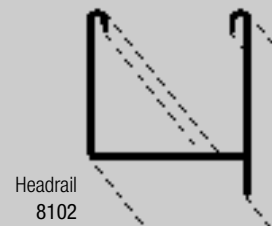
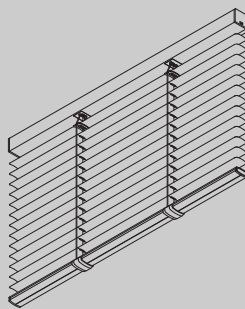

Price Group 1

Price Category C

Width Drop cm	60cm 2'0"	80cm 2'7"	100cm 3'3"	120cm 3'11"	140cm 4'7"	160cm 5'3"	180cm 5'11"	200cm 6'6"	220cm 7'3"	240cm 7'10"	260cm 8'6"	280cm 9'2"	300cm 9'10"	Width Drop ft.ins.
60	495.43	518.66	541.86	565.09	588.34	611.53	634.75	657.99	681.21	704.45	727.66	750.88	774.11	2'0"
80	498.94	523.19	547.42	571.64	595.87	620.11	644.35	668.59	692.82	717.06	741.29	765.53	789.73	2'7"
100	502.49	527.70	552.96	578.21	603.43	628.70	653.94	679.19	704.44	729.65	754.93	780.14	805.43	3'3"
120	505.99	532.23	558.50	584.76	611.01	637.26	663.53	689.77	716.05	742.29	768.54	794.81	821.07	3'11"
140	509.50	536.78	564.03	591.30	618.57	645.82	673.09	700.36	727.65	754.92	782.18	809.46	836.70	4'7"
160	513.00	541.29	569.57	597.84	626.15	654.41	682.69	710.95	739.24	767.53	795.80	824.07	852.36	5'3"
180	516.53	545.81	575.10	604.38	633.70	662.99	692.28	721.56	750.83	780.13	809.43			5'11"
200	520.05	550.33	580.66	610.97	641.26	671.57	701.85	732.13	762.45	792.75				6'6"
220		554.87	586.20	617.51	648.81	680.13	711.44	742.74	774.05					7'3"
240		559.38	591.72	624.06	656.39	688.69	721.02	753.33						7'10"
260		563.91	597.27	630.60	663.93	697.27	730.61							8'6"
280		568.43	602.82	637.15	671.50	705.84								9'2"
300		572.99	608.34	643.71	679.07	714.41								9'10"
320		577.52	613.90	650.24	686.61									10'6"
340		582.03	619.42	656.79	694.20									11'2"

Price Group 2

Price Category C

Width Drop cm	60cm 2'0"	80cm 2'7"	100cm 3'3"	120cm 3'11"	140cm 4'7"	160cm 5'3"	180cm 5'11"	200cm 6'6"	220cm 7'3"	240cm 7'10"	260cm 8'6"	280cm 9'2"	300cm 9'10"	Width Drop ft.ins.
60	500.29	525.12	549.96	574.80	599.67	624.50	649.32	674.18	699.00	723.86	748.69	773.53	798.37	2'0"
80	504.38	530.47	556.54	582.55	608.65	634.68	660.73	686.79	712.85	738.90	764.95	791.02	817.05	2'7"
100	508.53	535.80	563.06	590.33	617.59	644.86	672.15	699.43	726.65	753.95	781.21	808.47	835.72	3'3"
120	512.66	541.14	569.63	598.09	626.58	655.06	683.54	712.02	740.51	769.01	797.47	825.95	854.44	3'11"
140	516.78	546.48	576.16	605.88	635.54	665.25	694.95	724.64	754.33	784.03	813.73	843.43	873.13	4'7"
160	520.93	551.81	582.72	613.63	644.53	675.44	706.34	737.28	768.16	799.07	829.99	860.90	891.80	5'3"
180	525.02	557.14	589.26	621.38	653.52	685.62	717.77	749.87	781.99	814.13	846.23			5'11"
200	529.13	562.48	595.81	629.12	662.49	695.84	729.16	762.47	795.83	829.17				6'6"
220		567.80	602.36	636.91	671.46	706.00	740.57	775.13	809.66					7'3"
240		573.14	608.89	644.68	680.45	716.18	751.97	787.72						7'10"
260		578.50	615.44	652.44	689.42	726.39	763.35							8'6"
280		583.82	622.05	660.20	698.41	736.58								9'2"
300		589.17	628.57	667.98	707.35	746.78								9'10"
320		594.49	635.13	675.73	716.37									10'6"
340		599.83	641.65	683.49	725.33									11'2"

Price Group 3

Price Category C

Width Drop cm	60cm 2'0"	80cm 2'7"	100cm 3'3"	120cm 3'11"	140cm 4'7"	160cm 5'3"	180cm 5'11"	200cm 6'6"	220cm 7'3"	240cm 7'10"	260cm 8'6"	280cm 9'2"	300cm 9'10"	Width Drop ft.ins.
60	509.99	538.06	566.17	594.23	622.32	650.38	678.46	706.52	734.59	762.70	790.77	818.85	846.93	2'0"
80	515.32	545.01	574.71	604.39	634.12	663.81	693.51	723.19	752.90	782.60	812.30	841.99	871.67	2'7"
100	520.68	551.98	583.29	614.60	645.92	677.23	708.56	739.87	771.16	802.45	833.82	865.09	896.42	3'3"
120	525.99	558.93	591.89	624.80	657.74	690.66	723.62	756.52	789.43	822.35	855.33	888.25	921.18	3'11"
140	531.32	565.89	600.45	634.98	669.51	704.09	738.63	773.19	807.74	842.30	876.82	911.37	945.93	4'7"
160	536.67	572.86	609.02	645.17	681.36	717.51	753.66	789.87	826.02	862.19	898.32	934.53	970.68	5'3"
180	542.03	579.80	617.58	655.37	693.15	730.94	768.73	806.51	844.29	882.09	919.84			5'11"
200	547.36	586.73	626.17	665.56	704.97	744.38	783.77	823.16	862.58	901.97				6'6"
220		593.70	634.73	675.74	716.75	757.80	798.82	839.83	880.84					7'3"
240		600.65	643.31	685.93	728.59	771.20	813.86	856.51						7'10"
260		607.63	651.87	696.14	740.37	784.65	828.91							8'6"
280		614.57	660.45	706.32	752.19	798.07								9'2"
300		621.53	669.01	716.50	764.00	811.50								9'10"
320		628.46	677.58	726.70	775.82									10'6"
340		635.43	686.17	736.86	787.63									11'2"

All prices shown exclude VAT



Venetian Blinds

System 8300 (16mm)

Mono control Venetian Blind System.
 Slats 16mm.
 Maximum System Width: 3m
 Minimum System Width: 50cm
 Maximum System Drop: 3m
 Maximum Surface Area: 4.5m²

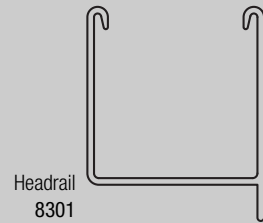
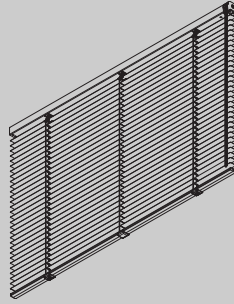

The prices in the tables below comprise the complete system made-to-measure with 16mm slats ready to hang. If sizes lie between the measurements shown, the price for the next size larger will apply. Chain drop as standard will be on the right-hand side and as close to the overall depth of the blind as possible but not below the bottom bar unless otherwise stated. For side-guide or sloping add 20%.

Price Group 1

Price Category C

Width Drop cm	60cm 2'0"	80cm 2'7"	100cm 3'3"	120cm 3'11"	140cm 4'7"	160cm 5'3"	180cm 5'11"	200cm 6'6"	220cm 7'3"	240cm 7'10"	260cm 8'6"	280cm 9'2"	300cm 9'10"	Width Drop ft.ins.
60	135.82	149.30	162.78	176.26	189.77	203.24	216.72	230.22	243.69	257.16	270.65	284.14	297.63	2'0"
80	139.74	154.53	169.32	184.11	198.90	213.69	228.48	243.29	258.08	272.86	287.66	302.44	317.23	2'7"
100	143.65	159.76	175.86	191.96	208.05	224.16	240.25	256.36	272.45	288.54	304.64	320.75	336.84	3'3"
120	147.58	165.00	182.39	199.80	217.21	234.61	252.02	269.44	286.83	304.23	321.65	339.05	356.46	3'11"
140	151.49	170.22	188.93	207.65	226.36	245.07	263.79	282.50	301.21	319.94	338.65	357.36	376.06	4'7"
160	155.43	175.45	195.47	215.48	235.52	255.53	275.56	295.58	315.58	335.63	355.64	375.65	395.67	5'3"
180	159.35	180.68	202.00	223.33	244.67	265.99	287.32	308.65	329.97	351.31	372.63			5'11"
200	163.28	185.92	208.54	231.18	253.81	276.45	299.09	321.72	344.35	366.99				6'6"
220	167.19	191.15	215.08	239.03	262.97	286.91	310.85	334.80	358.75					7'3"
240	171.11	196.37	221.61	246.87	272.13	297.36	322.63	347.87						7'10"
260	175.04	201.60	228.15	254.71	281.27	307.82	334.39							8'6"
280	178.97	206.83	234.70	262.56	290.42	318.29								9'2"
300	182.89	212.07	241.23	270.41	299.58	328.76								9'10"

Price Group 2

Price Category C

Width Drop cm	60cm 2'0"	80cm 2'7"	100cm 3'3"	120cm 3'11"	140cm 4'7"	160cm 5'3"	180cm 5'11"	200cm 6'6"	220cm 7'3"	240cm 7'10"	260cm 8'6"	280cm 9'2"	300cm 9'10"	Width Drop ft.ins.
60	140.12	155.04	169.97	184.89	199.80	214.71	229.65	244.57	259.49	274.41	289.33	304.25	319.17	2'0"
80	145.48	162.19	178.90	195.61	212.31	229.02	245.73	262.42	279.14	295.85	312.54	329.25	345.95	2'7"
100	150.84	169.34	187.83	206.31	224.82	243.31	261.78	280.29	298.78	317.26	335.76	354.26	372.74	3'3"
120	156.20	176.48	196.75	217.04	237.30	257.58	277.87	298.15	318.41	338.71	358.98	379.26	399.54	3'11"
140	161.57	183.63	205.69	227.75	249.82	271.88	293.95	316.02	338.08	360.14	382.20	404.26	426.35	4'7"
160	166.92	190.77	214.62	238.48	262.32	286.16	310.02	333.86	357.72	381.56	405.43	429.27	453.13	5'3"
180	172.28	197.92	223.54	249.19	274.81	300.46	326.09	351.73	377.37	402.81	428.64			5'11"
200	177.62	205.05	232.48	259.91	287.34	314.75	342.19	369.59	397.01	424.44				6'6"
220	182.99	212.19	241.41	270.61	299.83	329.03	358.24	387.47	416.67					7'3"
240	188.36	219.34	250.34	281.33	312.33	343.33	374.31	405.31						7'10"
260	193.71	226.49	259.27	292.06	324.84	357.61	390.40							8'6"
280	199.07	233.63	268.19	302.77	337.34	371.90								9'2"
300	204.42	240.78	277.13	313.50	349.83	386.20								9'10"

Price Group 3

Price Category C

Width Drop cm	60cm 2'0"	80cm 2'7"	100cm 3'3"	120cm 3'11"	140cm 4'7"	160cm 5'3"	180cm 5'11"	200cm 6'6"	220cm 7'3"	240cm 7'10"	260cm 8'6"	280cm 9'2"	300cm 9'10"	Width Drop ft.ins.
60	150.69	167.23	183.76	200.29	216.84	233.37	249.91	266.44	282.97	299.51	316.06	332.58	349.12	2'0"
80	157.10	175.77	194.43	213.11	231.76	250.44	269.12	287.78	306.45	325.11	343.78	362.46	381.13	2'7"
100	163.49	184.30	205.11	225.90	246.71	267.51	288.31	309.11	329.92	350.72	371.53	392.31	413.12	3'3"
120	169.90	192.83	215.76	238.70	261.65	284.58	307.53	330.44	353.38	376.31	399.26	422.20	445.12	3'11"
140	176.29	201.35	226.44	251.51	276.58	301.66	326.71	351.78	376.86	401.93	426.99	452.07	477.13	4'7"
160	182.70	209.90	237.12	264.30	291.50	318.70	345.90	373.13	400.32	427.52	454.73	481.93	509.13	5'3"
180	189.11	218.43	247.77	277.11	306.45	335.78	365.11	394.45	423.78	453.13	482.46			5'11"
200	195.50	226.97	258.44	289.91	321.38	352.84	384.31	415.84	447.26	478.73				6'6"
220	201.90	235.51	269.11	302.71	336.31	369.91	403.52	437.12	470.73					7'3"
240	208.30	244.04	279.76	315.51	351.24	386.98	422.72	458.44						7'10"
260	214.69	252.57	290.43	328.30	366.18	404.05	441.91							8'6"
280	221.10	261.11	301.11	341.12	381.12	421.13								9'2"
300	227.50	269.63	311.78	353.92	396.05	438.18								9'10"

All prices shown exclude VAT



Venetian Blinds

System 8300 (25mm)

Mono control Venetian Blind System.

Slats 25mm.

Maximum System Width: 3m

Minimum System Width: 50cm

Maximum System Drop: 3m

Maximum Surface Area: 4.5m²

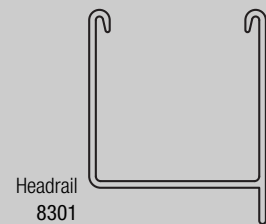
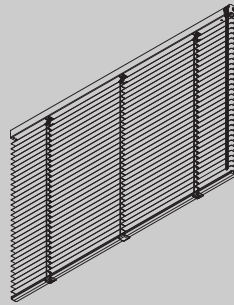

The prices in the tables below comprise the complete system made-to-measure with 25mm slats ready to hang. If sizes lie between the measurements shown, the price for the next size larger will apply. Chain drop as standard will be on the right-hand side and as close to the overall depth of the blind as possible but not below the bottom bar unless otherwise stated. For side-guide or sloping add 20%.

Price Group 1

Price Category C

Width Drop cm	60cm 2'0"	80cm 2'7"	100cm 3'3"	120cm 3'11"	140cm 4'7"	160cm 5'3"	180cm 5'11"	200cm 6'6"	220cm 7'3"	240cm 7'10"	260cm 8'6"	280cm 9'2"	300cm 9'10"	Width Drop ft.ins.
60	126.83	140.04	153.25	166.48	179.68	192.90	206.12	219.34	232.56	245.77	258.99	272.21	285.43	2'0"
80	130.20	144.55	158.89	173.24	187.57	201.92	216.27	230.61	244.95	259.29	273.64	287.98	302.34	2'7"
100	133.58	149.04	164.51	180.00	195.47	210.92	226.40	241.87	257.35	272.81	288.29	303.76	319.22	3'3"
120	136.97	153.56	170.16	186.75	203.34	219.94	236.55	253.14	269.75	286.34	302.92	319.53	336.12	3'11"
140	140.35	158.06	175.79	193.52	211.23	228.96	246.69	264.41	282.14	299.85	317.57	335.31	353.02	4'7"
160	143.71	162.56	181.42	200.27	219.12	237.97	256.82	275.67	294.53	313.37	332.21	351.08	369.92	5'3"
180	147.09	167.08	187.05	207.04	227.01	246.97	266.97	286.93	306.92	326.89	346.87			5'11"
200	150.48	171.58	192.69	213.79	234.89	256.00	277.10	298.21	319.32	340.42				6'6"
220	153.86	176.09	198.33	220.55	242.78	265.01	287.23	309.47	331.71					7'3"
240	157.24	180.61	203.95	227.31	250.67	274.02	297.37	320.74						7'10"
260	160.61	185.09	209.58	234.07	258.54	283.02	307.53							8'6"
280	164.01	189.60	215.23	240.82	266.44	292.05								9'2"
300	167.38	194.12	220.86	247.59	274.33	301.06								9'10"

Price Group 2

Price Category C

Width Drop cm	60cm 2'0"	80cm 2'7"	100cm 3'3"	120cm 3'11"	140cm 4'7"	160cm 5'3"	180cm 5'11"	200cm 6'6"	220cm 7'3"	240cm 7'10"	260cm 8'6"	280cm 9'2"	300cm 9'10"	Width Drop ft.ins.
60	130.52	144.97	159.42	173.87	188.33	202.77	217.23	231.68	246.12	260.58	275.03	289.47	303.93	2'0"
80	135.14	151.12	167.12	183.10	199.09	215.07	231.06	247.06	263.04	279.03	295.01	310.99	326.99	2'7"
100	139.75	157.27	174.80	192.32	209.85	227.37	244.91	262.42	279.95	297.47	315.00	332.54	350.06	3'3"
120	144.35	163.42	182.49	201.56	220.62	239.68	258.75	277.80	296.87	315.92	334.99	354.06	373.13	3'11"
140	148.98	169.59	190.18	210.78	231.38	251.99	272.58	293.19	313.79	334.39	354.99	375.59	396.18	4'7"
160	153.58	175.73	197.86	220.01	242.14	264.28	286.42	308.57	330.70	352.84	374.96	397.12	419.26	5'3"
180	158.20	181.87	205.55	229.24	252.91	276.59	300.27	323.94	347.60	371.29	394.97			5'11"
200	162.80	188.03	213.24	238.45	263.67	288.87	314.10	339.32	364.54	389.75				6'6"
220	167.42	194.18	220.94	247.67	274.43	301.19	327.93	354.69	381.45					7'3"
240	172.03	200.32	228.63	256.89	285.20	313.50	341.77	370.07						7'10"
260	176.65	206.48	236.30	266.14	295.96	325.79	355.62							8'6"
280	181.27	212.63	244.01	275.36	306.72	338.09								9'2"
300	185.88	218.79	251.68	284.59	317.49	350.40								9'10"

Price Group 3

Price Category C

Width Drop cm	60cm 2'0"	80cm 2'7"	100cm 3'3"	120cm 3'11"	140cm 4'7"	160cm 5'3"	180cm 5'11"	200cm 6'6"	220cm 7'3"	240cm 7'10"	260cm 8'6"	280cm 9'2"	300cm 9'10"	Width Drop ft.ins.
60	149.63	167.60	185.56	203.54	221.49	239.45	257.42	275.39	293.36	311.32	329.28	347.24	365.22	2'0"
80	157.77	178.44	199.11	219.79	240.46	261.13	281.82	302.48	323.16	343.83	364.51	385.18	405.86	2'7"
100	165.88	189.26	212.65	236.03	259.44	282.81	306.19	329.58	352.96	376.33	399.72	423.11	446.49	3'3"
120	174.01	200.10	226.20	252.29	278.38	304.48	330.57	356.67	382.76	408.85	434.95	461.04	487.14	3'11"
140	182.13	210.95	239.75	268.55	297.35	326.15	354.97	383.76	412.57	441.37	470.18	498.97	527.77	4'7"
160	190.27	221.78	253.29	284.81	316.33	347.83	379.35	410.85	442.37	473.87	505.39	536.90	568.42	5'3"
180	198.40	232.62	266.84	301.06	335.30	369.50	403.73	437.95	472.17	506.39	540.62			5'11"
200	206.53	243.45	280.38	317.31	354.25	391.17	428.11	465.05	501.99	538.92				6'6"
220	214.65	254.29	293.94	333.57	373.21	412.85	452.50	492.13	531.78					7'3"
240	222.79	265.13	307.48	349.83	392.18	434.54	476.89	519.22						7'10"
260	230.92	275.98	321.03	366.08	411.16	456.21	501.25							8'6"
280	239.05	286.81	334.57	382.35	430.11	477.89								9'2"
300	247.17	297.65	348.12	398.60	449.07	499.56								9'10"

All prices shown exclude VAT



Wooden Slat Venetian Blinds

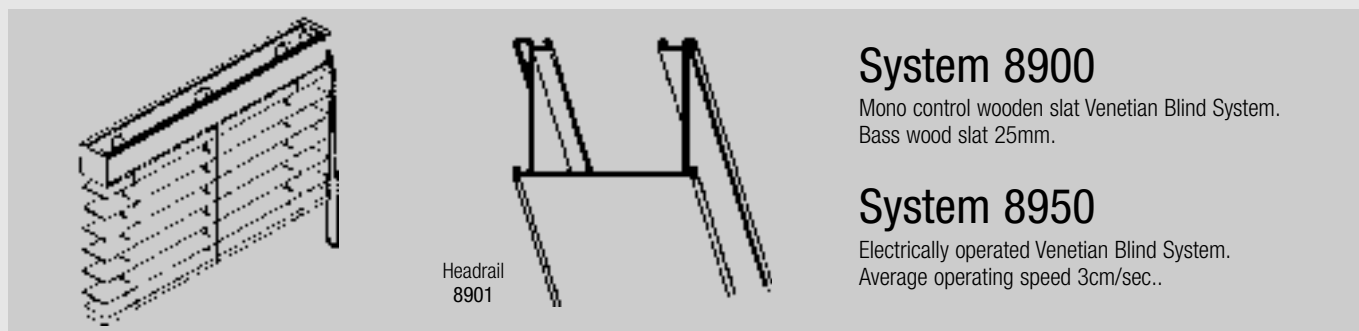

The prices in the table below comprise the complete system made-to-measure with 25mm slats ready to hang with universal bracket 0511. If sizes lie between the measurements shown, the price for the next size larger will apply. Headrail covered with actual slat to match. For F.R. treated wood please add £99.86/m² to prices below.

System 8900 – 25mm Slat size

Max. system width: 243cm Min. system width: 40cm
 Max. system drop: 275cm Max. surface area: 4.4m²

Cord drop as standard will be on R/H side and as close to overall drop of blind as possible but never below bottom bar unless otherwise stated.

Price Category C

Width ► Drop ▼ cm	60cm 2'0"	80cm 2'7"	100cm 3'3"	120cm 3'11"	140cm 4'7"	160cm 5'3"	180cm 5'11"	200cm 6'6"	220cm 7'3"	245cm 8'1"	◀ Width ▼ Drop ft/ins
60	156.21	188.13	227.89	255.92	283.95	331.55	359.58	387.61	435.22	466.33	2'0"
70	164.04	203.76	255.28	287.21	315.25	370.66	402.63	434.56	486.04	521.10	2'4"
80	171.85	215.49	265.06	298.95	328.91	388.28	420.20	454.09	509.52	546.49	2'7"
90	179.66	227.24	274.82	310.69	342.64	405.87	437.79	473.66	532.98	571.92	2'11"
100	191.38	239.02	298.30	338.08	373.92	441.07	480.83	520.60	583.85	626.69	3'3"
110	195.31	246.80	310.05	349.80	389.58	458.67	500.40	540.18	607.30	650.17	3'7"
120	199.23	254.64	321.77	361.52	405.21	476.28	519.95	559.74	630.77	673.64	3'11"
130	207.04	274.20	345.25	400.68	436.52	515.38	559.08	606.64	685.54	732.30	4'3"
140	212.90	283.96	357.00	408.48	450.19	532.99	578.61	626.21	709.00	755.77	4'7"
150	218.78	293.75	368.72	416.33	463.90	550.62	598.18	645.75	732.49	779.27	4'9"
160	226.61	317.22	392.19	443.70	495.19	589.71	641.22	688.82	783.32	837.92	5'3"
170	232.45	325.03	403.92	455.42	508.88	605.37	658.81	710.32	806.79		5'7"
180	238.33	332.88	415.66	467.17	522.55	621.00	676.41	731.84	830.28		5'11"
190	246.16	344.59	427.43	482.79	538.24	640.55	697.95	753.35			6'3"
200	253.99	356.33	439.12	498.46	553.86	660.13	719.43	774.87			6'6"
210	265.70	375.90	462.59	525.84	585.17	699.26	762.48				7'0"
220	273.57	385.67	474.34	537.59	598.80	716.85	780.07				7'3"
230	281.35	395.45	486.06	549.30	612.45	734.45					7'7"
240	293.10	415.03	509.54	576.70	643.83	769.64					7'10"
250	298.97	424.79	521.27	590.37	657.52	787.25					8'2"
260	304.84	434.57	532.99	604.06	671.19						8'6"
275	320.47	454.12	556.47	631.45	702.51						9'0"

Wooden slat Venetian blinds are made with natural wood. It is therefore an inherent feature of the product that variation in shade and graining as well as slight warping may occur.

System 8950 – 25mm Slat size

Max. system width: 245cm Min. system width: 60cm
 Max. system drop: 275cm Max. surface area: 4.4m²

Based on 8900 System components with integral 230v motor no. 0611. Supplied with special recess switch 0613 as standard. For pricing, add to relevant price in table above the sum of **£622.49**

All prices shown
exclude VAT



Wooden Slat Venetian Blinds

System 8900

Mono control wooden slat Venetian Blind System.
Bass wood slat 50mm.

System 8950

Electrically operated Venetian Blind System.
Average operating speed 3cm/sec.

The prices in the table below comprise the complete system made-to-measure with 50mm slats ready to hang with universal bracket 0511. If sizes lie between the measurements shown, the price for the next size larger will apply. Headrail covered with actual slat to match. For F.R. treated wood please add £96.95/m² to prices below.

System 8900 – 50mm Slat size

Max. system width: 243cm Min. system width: 40cm
 Max. system drop: 275cm Max. surface area: 4.6m²

Cord drop as standard will be on R/H side and as close to overall drop of blind as possible but never below bottom bar unless otherwise stated.

Price Category C

Width ► Drop ▼ cm	80cm 2'7"	100cm 3'3"	120cm 3'11"	140cm 4'7"	160cm 5'3"	180cm 5'11"	200cm 6'6"	220cm 7'3"	245cm 8'1"	◀ Width ▼ Drop ft/ins
80	229.22	282.70	300.12	371.81	447.58	447.58	489.38	508.52	552.07	2'7"
90	234.66	288.94	307.13	381.41	397.68	458.89	503.25	523.33	567.81	2'11"
100	240.10	295.17	314.12	391.00	408.11	470.20	517.10	538.13	583.55	3'3"
110	248.26	304.53	324.64	405.33	423.77	487.16	537.92	560.29	607.09	3'7"
120	262.70	343.11	343.11	414.89	434.23	498.47	551.80	575.10	622.83	3'11"
130	277.14	338.27	361.58	424.46	444.67	509.78	565.68	589.91	638.56	4'3"
140	289.33	352.23	377.25	443.65	465.58	532.40	593.39	619.48	669.98	4'7"
150	293.90	357.44	383.14	450.82	473.42	540.90	603.81	630.59	681.79	4'9"
160	298.46	362.65	389.02	457.98	481.25	549.41	614.21	641.68	693.58	5'3"
170	310.65	376.61	404.64	477.12	502.10	572.03	628.07	671.25	725.01	5'7"
180	323.49	391.51	421.12	496.71	523.24	595.28	641.97	686.06	740.72	5'11"
190	336.33	406.41	437.60	516.29	544.38	618.52	669.69	700.87	756.43	6'3"
200	346.02	417.53	450.11	531.58	561.01	636.55	690.50	723.07		6'6"
210	352.51	424.93	458.43	541.76	572.11	648.56	704.39			7'0"
220	359.00	432.32	466.74	551.93	583.22	660.56	718.26			7'3"
230	371.92	447.10	483.39	572.23	605.41	684.61	745.98			7'7"
240	376.79	452.66	489.62	579.88	613.74	693.63				7'10"
250	381.66	458.23	495.85	587.52	622.06	702.65				8'2"
260	394.59	473.02	512.50	607.88	644.25	726.70				8'6"
275	409.28	485.78	525.23	620.61	655.58					9'0"

Wooden slat Venetian blinds are made with natural wood. It is therefore an inherent feature of the product that variation in shade and graining as well as slight warping may occur.

For Premium colour/finishes as detailed on Page 59: an additional cost of 20% applies.

TAPED VENETIAN System 8900 (only with 50mm slat) is available with fabric tapes at an additional cost of 5%. Please enquire at Silent Gliss for information about the colours available.

System 8950 – 50mm Slat size

Max. system width: 245cm Min. system width: 60cm
 Max. system drop: 275cm Max. surface area: 4.6m²

Based on 8900 System components with integral 230v motor no. 0611. Supplied with special recess switch 0613 as standard. For pricing, add to relevant price in table above the sum of **£658.76**

System 8950 is available with fabric tapes at an additional cost of 5%.

SIDE-GUIDES are available for both systems at an additional cost of **£22.60**

All prices shown
exclude VAT



Aluminium Slat Venetian Blind

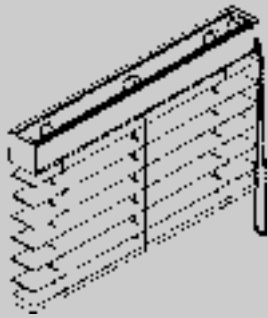

Headrail
8901

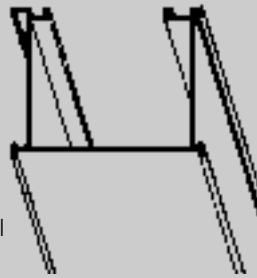

System 8900

Mono control Venetian Blind System.
Aluminium slat 50mm.

System 8950

Electrically operated Venetian Blind System.
Average operating speed 3cm/sec.

The prices in the table below comprise the complete system made-to-measure with 50mm slats ready to hang with universal bracket 0511. If sizes lie between the measurements shown, the price for the next size larger will apply. Headrail covered with actual slat to match. Three colours colour coordinated (white, cream and black). For any other colour, headrail and bottom rail can be coloured to match the slat choice at an extra charge of £97.25 (Cat C).

Multicoloured blinds please add 20% to prices below.

System 8900 – 50mm Slat size

Max. system width: 360cm
Max. system drop: 360cm
Min. system width: 40cm
Max. surface area: 10m²

Cord drop as standard will be on R/H side and as close to overall drop of blind as possible but never below bottom bar unless otherwise stated.

Price Category C

Width ► Drop ▼ cm	60cm 2'0"	80cm 2'7"	100cm 3'3"	120cm 3'11"	140cm 4'7"	160cm 5'3"	180cm 5'11"	200cm 6'6"	220cm 7'3"	240cm 7'10"	260cm 8'6"	280cm 9'2"	300cm 9'10"	320cm 10'6"	340cm 11'2"	360cm 11'10"	Width ▼ Drop ft/ins
60	94.37	119.22	144.10	168.90	193.78	218.59	243.49	268.38	293.19	318.03	342.83	367.73	392.58	417.41	442.28	467.11	2'0"
70	97.01	121.88	146.67	171.55	196.42	221.26	246.10	270.93	295.79	320.69	345.53	370.37	395.21	420.01	444.92	469.74	2'4"
80	99.68	124.55	149.33	174.20	199.01	223.90	248.76	273.58	298.41	323.27	348.13	373.01	397.85	422.65	447.49	472.41	2'7"
90	102.28	127.12	151.99	176.84	201.69	226.52	251.40	276.20	301.06	325.91	350.78	375.63	400.45	425.32	450.14	475.01	2'11"
100	104.91	129.76	154.61	179.48	204.31	229.16	254.04	278.87	303.69	328.59	353.39	378.25	403.09	427.94	452.79	477.64	3'3"
110	107.52	132.38	157.26	182.08	206.95	231.78	256.63	281.51	306.32	331.22	356.03	380.86	405.68	430.57	455.45	480.29	3'7"
120	110.15	135.05	159.86	184.70	209.61	234.42	259.29	284.13	308.97	333.66	358.67	383.52	408.35	433.18	458.05	482.89	3'11"
130	112.81	137.69	162.51	187.34	212.18	237.02	261.90	286.77	311.61	336.45	361.30	386.13	411.02	435.87	460.70	485.51	4'3"
140	115.44	140.30	165.17	189.97	214.85	239.68	264.52	289.36	314.24	339.06	363.91	388.83	413.63	438.48	463.36	488.18	4'7"
150	118.07	142.93	167.79	192.61	217.47	242.33	267.18	292.03	316.86	341.69	366.50	391.43	416.25	441.08	465.97	490.78	4'9"
160	120.70	145.55	170.42	195.25	220.11	244.95	269.81	294.65	319.48	344.35	369.16	394.05	418.89	443.73	468.60	493.40	5'3"
170	123.34	148.21	172.99	197.87	222.76	247.59	272.47	297.28	322.08	346.97	371.82	396.70	421.53	446.33	471.20	496.06	5'7"
180	125.97	150.87	175.64	200.48	225.33	250.22	275.08	299.92	324.75	349.61	374.44	399.31	424.15	448.99	473.83	498.70	5'11"
190	128.63	153.44	178.31	203.18	228.00	252.81	277.71	302.54	327.38	352.26	377.09	401.97	426.79	451.61	476.46	501.29	6'3"
200	131.23	156.08	180.95	205.76	230.64	255.44	280.29	305.16	330.00	354.91	379.72	404.58	429.40	454.27	479.16	503.98	6'6"
210	133.86	158.69	183.58	208.41	233.28	258.14	282.92	307.76	332.63	357.48	382.37	407.22	432.01	456.87	481.76	506.62	7'0"
220	136.48	161.37	186.17	211.04	235.89	260.72	285.62	310.47	335.31	360.11	384.97	409.83	434.69	459.51	484.39	509.19	7'3"
230	139.11	163.98	188.82	213.68	238.52	263.35	288.22	313.08	337.94	362.77	387.61	412.44	437.29	462.15	487.01	511.86	7'7"
240	141.78	166.63	191.48	216.30	241.13	265.99	290.84	315.74	340.56	365.40	390.22	415.09	439.94	464.76	489.66	514.46	7'10"
250	144.38	169.26	194.11	218.92	243.76	268.62	293.47	318.34	343.18	368.05	392.86	417.73	442.55	467.42	492.29	517.10	8'2"
260	147.04	171.87	196.71	221.57	246.42	271.27	296.14	320.96	345.79	370.66	395.50	420.39	445.24	470.05	494.89	519.74	8'6"
270	149.66	174.53	199.34	224.19	249.03	273.90	298.78	323.60	348.41	373.28	398.13	423.02	447.84	472.69	497.55	522.39	9'0"
280	152.28	177.16	201.97	226.82	251.68	276.50	301.42	326.24	351.07	375.90	400.75	425.64	450.47	475.31	500.15	525.03	9'2"
290	154.92	179.77	204.61	229.45	254.34	279.14	304.03	328.87	353.69	378.58	403.40	428.21	453.10	477.92	502.82	527.65	9'6"
300	157.51	182.41	207.25	232.06	256.97	281.80	306.63	331.50	356.32	381.20	406.09	430.91	455.73	480.56	505.42		9'10"
310	160.17	185.05	209.86	234.71	259.59	284.41	309.27	334.11	358.97	383.80	408.70	433.55	458.35	483.21	508.05		10'2"
320	162.79	187.68	212.51	237.37	262.24	287.03	311.89	336.76	361.60	386.44	411.28	436.17	461.01	485.86			10'6"
330	165.44	190.26	215.14	240.01	264.83	289.68	314.53	339.33	364.23	389.10	413.92	438.79	463.61	488.49			10'10"
340	168.08	192.93	217.76	242.62	267.45	292.33	317.18	342.03	366.86	391.71	416.55	441.40	466.24				11'2"
350	170.71	195.55	220.41	245.26	270.11	294.94	319.80	344.67	369.49	394.37	419.19	444.07	468.87				11'6"
360	173.35	198.24	223.05	247.87	272.72	297.59	322.45	347.27	372.13	396.97	421.83	446.67	471.52				11'10"

System 8950 – 50mm Slat size

Max. system width: 360cm
Max. system drop: 360cm
Min. system width: 60cm
Max. surface area: 10m²

Based on 8900 System components with integral 230v motor no. 0611. Supplied with special recess switch 0613 as standard. For pricing, add to relevant price in table above the sum of £622.49

System 8950 is available with fabric tapes at additional cost of 5%.

SIDE-GUIDES are available for both systems at an additional cost of £22.60

All prices shown exclude VAT



Plissée Pleated Blinds

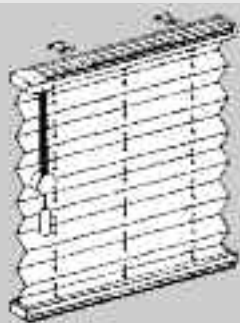

System 8500

Plissée Pleated Blind System supplied complete ready made.
White aluminium head and bottom rail. Pleats 20mm.

Plissée Pleated Blind Systems are supplied made-to-measure, ready to install. White aluminium headrail and components are standard and brown is also available.

Please use our technical information leaflet to determine the required Plissée model and contact Silent Gliss for a price.

Choose from following model types:

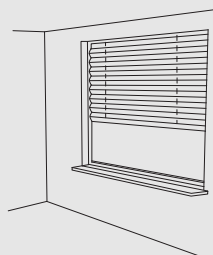

Model Type 'A' – Vertical Freehanging

Electric Operation: AE10

Chain Operation: AK10

Pull Cord Operation: A010, A013, A020, A030, A040, A070

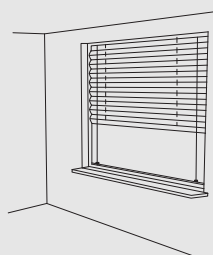

Model Type 'B' – Vertical Side-Guide

Electrical Operation: BE10

Handle Operation: BB10, BB10U, BB20, BB20U, BB24, BB30, BB80, BB81, BB85

Chain Operation: BK10

Pull Chord Operation: B010, B020, B060, B061, B075

Fixed: BF50, BF51, BF52, BF55, BF56

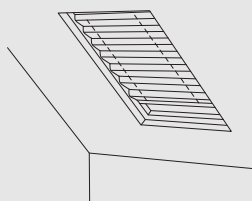

Model Type 'D' – Inclined

Handle Operation: DB10, DB10U, DB20, DB30

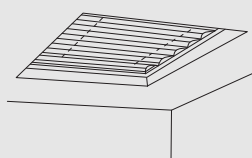

Model Type 'P' – Horizontal

Handle Operation: PB10, PB15, PB30, PB35, PB40, PB41, PB45, PB46, PB60, PB61, PB65, PB66, PB70, PB71, PB75, PB76, PB80, PB81, PB85, PB86

Electrical Operation: PE10, PE15, PE60, PE61, PE65, PE66, PE70, PE71, PE75, PE76

Crank Operation: PR10, PR15, PR60, PR61, PR65, PR66, PR70, PR71, PR75, PR76

PRICING: Price on application – please contact Silent Gliss

All prices shown exclude VAT



Logo and Digital Printing

We are able to print logos and images on a wide variety of fabrics, including Screens, Visiotex, Element, Mercurio B and Colorama. It is important to note that the denser the fabric, the better the quality of the image transfer.

Suitable artwork must be provided with a reasonable size and high d.p.i. (dots per inch). Prices on application.



Made-to-measure Curtains

Wave®

CURTAIN HEADING SYSTEM

Curtain prices need to be added to the hardware prices.

Prices are for unlined curtains.

For standard lining add 10% or for blackout lining add 15%.

Price Category C

Price Group 1 Fabrics

Colorama 1
Someo
Blackout B★

Width ► Drop ▼	150cm 4'9"	200cm 6'6"	250cm 8'2"	300cm 9'10"	350cm 11'5"	400cm 13'1"	450cm 14'9"	500cm 16'4"	◀ Width ▼ Drop
Up to 300cm	303.00	404.00	505.00	606.00	707.00	808.00	909.00	1010.00	9'10"
301-350cm	454.00	606.00	758.00	910.00	1062.00	1214.00	1366.00	1518.00	9'10"-11'5"
351-400cm	522.00	697.00	872.00	1047.00	1222.00	1397.00	1572.00	1747.00	11'5"-13'1"

★ Blackout B only suitable for use with Wave 80mm glider cord.

Price Group 2 Fabrics

Breeze
Freshtex Light
Freshtex Ultralight
Sunset
Colorama 2
Natural
Colorama 1 Alu

Colorama 2 Bioactive
Freshtex Linlook
Twist
Freshtex Vision
Reflex

Width ► Drop ▼	150cm 4'9"	200cm 6'6"	250cm 8'2"	300cm 9'10"	350cm 11'5"	400cm 13'1"	450cm 14'9"	500cm 16'4"	◀ Width ▼ Drop
Up to 300cm	416.00	554.00	692.00	830.00	968.00	1106.00	1244.00	1382.00	9'10"
301-350cm	624.00	831.00	1038.00	1245.00	1452.00	1659.00	1866.00	2073.00	9'10"-11'5"
351-400cm	718.00	956.00	1194.00	1432.00	1670.00	1908.00	2146.00	2384.00	11'5"-13'1"

Price Group 3 Fabrics

Deep
Freshtex Dimout
Linea
Newlife 1/2
Sevena

Width ► Drop ▼	150cm 4'9"	200cm 6'6"	250cm 8'2"	300cm 9'10"	350cm 11'5"	400cm 13'1"	450cm 14'9"	500cm 16'4"	◀ Width ▼ Drop
Up to 300cm	812.00	1082.00	1352.00	1622.00	1892.00	2162.00	2432.00	2702.00	9'10"
301-350cm	1218.00	1623.00	2028.00	2433.00	2838.00	3243.00	3648.00	4053.00	9'10"-11'5"
351-400cm	1400.00	1866.00	2332.00	2798.00	3264.00	3730.00	4196.00	4662.00	11'5"-13'1"

Fabric Joining Information

By reducing the number of joins the overall curtain appearance improves. The table below indicates the maximum drop available **without joins** for each fabric.

Max drop 210cm	Max drop 270cm	Max drop 290cm	Max drop 300cm
Colorama 1 Alu	Sevena Blackout B	Freshtex Ultralight Freshtex Vision Freshtex Light Newlife 1/2	Deep Freshtex Dimout Linea Sevena
			Breeze Colorama 2 Colorama 1
			Twist Colorama 2 Bioactive

All prices shown
exclude VAT

Price Index for Rails & Parts

All prices shown
exclude V.A.T.

Product	Description	Unit Prices					Per Metre Price				Ctgy
		Each	Per 10	Per 100	Other Qty	Price	1m	100m	Other Lgth	Price	
16R	Round Head Screw for 1225 No.6, 25mm/1"			6.86							A
18R	Round Head Screw No.8, 25mm/1"			12.98							A
28C	Counter Sunk Screw No.8, 50mm/2"			16.12							A
28R	Round Head Screw No.8, 50mm/2"			24.50							A
148C	Counter Sunk Screw No.8, 19mm/3/4"			13.54							A
0516	Clearance spacer (for top boards)			54.39							A
0521	Motor lead	82.08									C
0537	Adjustable Metropole bracket, silver, black, gunmetal, white, cream, steel grey, bronze, antique bronze, sand, taupe	6.46									A
0537	Adjustable Metropole bracket, chrome, classic gold, oak	7.36									A
0551	Diagonal fixing support complete including track and wall fixings	68.85			metre drop	10.87					A
0552	Transfer unit for loading device	206.19									A
0553	Connecting bridge for loading device	45.24									A
0554	Loading device access	96.35									A
0556	Ball end, silver, white, cream, black, classic gold, gunmetal, chrome, steel grey, bronze, antique bronze, sand, taupe (30mm poles)	22.89	217.46								A
0556	Ball end, oak (30mm poles)	26.22	244.65								A
0562	Lead with in-line connector	85.77									C
0565	Non latching recess switch, white, 1 gang	85.65									C
0566	Non latching recess switch, white, 2 gang	148.26									C
0567	Non latching recess switch, white, 3 gang	230.88									C
0568	Non latching recess switch, white, 4 gang	293.50									C
0569	Non latching recess switch, white, 6 gang	443.10									C
0570	Volt free switching module	161.75									C
0579A	Stop controller set	42.61									C
0593	Gland set for 5682	2.98									C
0595	Swivel plate	113.41									C
0614ST	Wireless switch, white	97.15									C
0616	Latching recess switch, white, 2 gang	62.34									C
0617	Latching recess switch, white, 3 gang	101.31									C
0618	Latching recess switch, white, 4 gang	121.83									C
0619	Latching recess switch, white, 6 gang	168.84									C
0628	Groove cylinder finial for 1003	16.04									A
0629	Groove cylinder finial for 6130	19.48									A
0630	Groove cylinder finial for 6140	45.07									A
0644	50mm pulley housing set (for 6160), white, silver, black	88.59									A
0644	50mm pulley housing set (for 6160), oak, steel grey, taupe	116.24									A
0646	50mm intermediate pulley set (for 6160), white, silver, black	54.82									A
0646	50mm intermediate pulley set (for 6160), oak, steel grey, taupe	60.70									A
0647	50mm Strata corded. Unslotted end - clear/ribbed disc, silver, black, white, steel grey, taupe, antique bronze	67.03	623.40								A
0647	50mm Strata corded. Unslotted end - clear/ribbed disc, oak	93.75	871.92								A
0647	50mm Strata corded. Unslotted end - coloured disc, silver, black, white, steel grey, taupe, antique bronze	76.41	710.59								A
0647	50mm Strata corded. Unslotted end - coloured disc, oak	103.13	959.10								A
0652	Screw										A
0661	Side guide wire										A
0674	Pillar bracket, white, silver, black, cream	8.34									A
0674	Pillar bracket, chrome, classic gold, gunmetal, steel grey, bronze, antique bronze, sand, taupe	9.40									A
0674	Pillar bracket, oak	23.10									A
0686	Bottom weight 89mm/3 1/3 without horns			86.94							C
0687	Bottom weight 127mm/5 without horns			67.82							C
0688	Self drilling wood screw (System 1221)			37.86							A
0690	Cord Connector White	1.99	18.95								A
0697	50mm Strata hand clear/ribbed disc, silver, black, white, steel grey, taupe, antique bronze	59.88	556.92								A
0697	50mm Strata hand clear/ribbed disc, oak	86.61	805.43								A
0697	50mm Strata hand coloured disc, silver, black, white, steel grey, taupe, antique bronze	69.26	644.11								A
0697	50mm Strata hand coloured disc, oak	95.98	892.63								A
0698	50mm Strata corded. Pair set. Clear/ribbed disc, silver, black, white, steel grey, taupe, antique bronze	134.08	1246.91								A
0698	50mm Strata corded. Pair set. Clear/ribbed disc, oak	187.52	1743.93								A

Price Index for Rails & Parts

All prices shown
exclude V.A.T.

Product	Description	Unit Prices					Per Metre Price				Ctgy
		Each	Per 10	Per 100	Other Qty	Price	1m	100m	Other Lgth	Price	
0698	50mm Strata corded. Pair set. Coloured disc, silver, black, white, steel grey, taupe, antique bronze	152.82	1421.22								A
0698	50mm Strata corded. Pair set. Coloured disc, oak	206.26	1918.22								A
0699	50mm Strata corded. Slotted end - clear/ribbed disc, silver, black, white, steel grey, taupe, antique bronze	67.03	623.40								A
0699	50mm Strata corded. Slotted end - clear/ribbed disc, oak	93.75	871.92								A
0699	50mm Strata corded. Slotted end - coloured disc, silver, black, white, steel grey, taupe, antique bronze	76.41	710.59								A
0699	50mm Strata corded. Slotted end - coloured disc, oak	103.13	959.10								A
0700	Profile for 6140 silver, white, black						37.58				A
0700	Profile for 6140, steel grey, oak, taupe, antique bronze						50.94				A
0701	50mm corded profile, white, silver, black						59.40				A
0701	50mm corded profile, oak, steel grey, taupe, antique bronze						68.86				A
0706	Endcap for 1003, silver, white, black, chrome, gunmetal, taupe	7.90	77.20	718.14							A
0707	Endcap for 6130, silver, white, cream, black, gunmetal, classic gold, chrome effect, steel grey, bronze, antique bronze, sand, taupe	6.74	63.94	607.48							A
0707	Endcap for 6130 oak	11.33	110.60	1053.27							A
0710	Endcap for 6101 silver, black, gunmetal, chrome, steel grey, bronze, antique bronze (includes grub screw)	6.84	65.00	615.74							A
0714	Endcover for 6140 50mm silver, white, black	21.00									A
0714	Endcover for 6140 50mm antique bronze, steel grey, oak, taupe,	21.50									A
0715	Dustcap for 6650								2.5m		A
0717	Ballend finial 50mm silver, white, black, antique bronze, steel grey, taupe,	67.12									A
0718	Spear finial 50mm silver, white, black, antique bronze, steel grey, taupe,	67.12									A
0719	Spear finial 30mm silver, white, black, antique bronze, steel grey, taupe,	33.11									A
0724	Connecting Bridge with Cover for 6130 All Colours	12.93									A
0766	In line connector for electric Roller blinds	53.92									C
0784	Glass discus only, (excl. bracket/arm) in red, white, amber, purple, lilac	56.26	520.34								A
0785	Acrylic disc for use with 6655	6.32									A
0788A	Holdback arm only, silver, white, cream, black, gunmetal, chrome effect, steel grey, bronze, antique bronze, sand, taupe	28.54	264.04								A
0797A	Midial bracket only, silver, white, cream, black, gunmetal, chrome effect, steel grey, bronze, classic gold, antique bronze, sand, taupe, oak	10.33	95.49								A
0839	Knot Holder	0.39									A
0871	Profile for 6150, white, silver						31.31				A
0871	Profile for 6150, black						38.20				A
0871	Profile for 6150, steel grey, antique bronze, taupe						42.43				A
0873	Design end cap for 6130, black, silver, white, steel grey, bronze, taupe, sand, antique bronze	14.90									A
0873	Design end cap for 6130, oak	20.50									A
0881	Vega Cube	44.00									A
0882	Vega Cylinder	29.60									A
0884	Crystal 23mm	41.64									A
0886	Crystal 30mm	54.85									A
0891	30mm Strata corded. Pair set. Clear/ribbed disc, standard colours	72.52	703.47								A
0891	30mm Strata corded. Pair set. Clear/ribbed disc, oak, chrome	100.81	977.82								A
0891	30mm Strata corded. Pair set. Coloured disc, silver, standard colours	72.52	703.47								A
0891	50mm Strata corded. Pair set. Coloured disc, oak, chrome	100.81	977.82								A
0892	Vega square midial (excl. Bracket/arm)	31.04	288.65								A
0893	Vega circle midial (excl. Bracket/arm)	29.12	270.81								A
0894	Crystal cylinder 23mm, base in white, silver, black, cream	47.55	442.22								A
0894	Crystal cylinder 23mm, base in chrome, gunmetal, taupe	50.98	474.08								A
0896	Crystal cylinder 30mm, base in white, silver, black, cream	57.90	538.44								A
0896	Crystal cylinder 30mm, base in chrome, bronze, classic gold, gunmetal, steel grey, antique bronze, sand, taupe	62.01	576.67								A
0898	Crystal square 50mm base	71.04									A
0899	Crystal cylinder 50mm base	74.28									A
0901	30mm Strata Hand clear/ribbed disc - standard colours	30.96									A
0901	30mm Strata Hand coloured disc - standard colours	41.84									A
0901	30mm Strata Hand clear/ribbed disc - oak/chrome	45.14									A
0901	30mm Strata Hand coloured disc - oak/chrome	56.05									A
0906	30mm Strata corded. Slotted end - clear/ribbed disc, standard colours	36.26	351.72								A
0906	30mm Strata corded. Slotted end - clear ribbed disc, oak, chrome	50.41	488.98								A
0906	30mm Strata corded. Slotted end - coloured disc, standard colours	36.26	351.72								A

Price Index for Rails & Parts

All prices shown
exclude V.A.T.

Product	Description	Unit Prices					Per Metre Price				Ctgy
		Each	Per 10	Per 100	Other Qty	Price	1m	100m	Other Lgth	Price	
0906	30mm Strata corded. Slotted end - coloured disc, oak/chrome	50.41	488.98								A
0907	Control module (low voltage motor Type A)	266.46									C
0910	30mm Strata corded. Unslotted end - clear/ribbed disc, standard colours	36.26	351.68								A
0910	30mm Strata corded. Unslotted end - clear/ribbed disc, oak, chrome	50.41	488.96								A
0910	30mm Strata corded. Unslotted end - coloured disc, standard colours	36.26	357.68								A
0910	30mm Strata corded. Unslotted end - coloured disc, oak	50.41	488.96								A
0913	Single-channel wall switch, brushed silver, mirror finish	193.29									C
0913	Single-channel wall switch, brass	221.63									C
0914	Eight-channel wall switch, brushed silver, mirror finish	193.29									C
0914	Eight-channel wall switch, brass	221.63									C
0915	Single-channel remote control	183.89									C
0917	White pattress box	17.25									C
0918	Control Module (Motor Type A)	246.82									C
0919	Control Module (Motor Type B)	246.82									C
0921	Booster for 0450 system	343.44									C
0922	Power supply for 0921 booster	99.30									C
0937	Programmable switch for 8250	117.27									C
0938	Black box for 0937	6.27									C
0939	Multi channel transmitter	239.11									C
0985	Groove Ball finial for 1003	35.58									A
0986	Groove Ball finial for 6130	40.42									A
0987/8	Groove Ball finial for 6120, pair of	110.89									A
0989	Blok Bracket for 6100, black, silver, gunmetal, steel grey, bronze, antique bronze	27.31									A
0989	Blok bracket for 6100, chrome	40.96									A
0991 CL	Shard Flat clear finial for 6100	30.30									A
0991 ET	Shard Flat etched finial for 6100	37.30									A
0993 CL	Shard Cylinder clear finial for 1003	32.97									A
0993 ET	Shard Cylinder etched finial for 1003	40.55									A
0995 CL	Shard Cylinder clear finial for 6130	38.70									A
0995 ET	Shard Cylinder etched finial for 6130	47.55									A
1003	Rail, silver, black, white in 6 metre lengths only						16.88				A
1003	Rail, gunmetal, steel grey, taupe, bronze in 6 metre lengths only						23.08				A
1003	Rail, chrome effect in 4 metre lengths only						26.93				A
1011	Rail, silver in 6 metre lengths only						7.63				A
1011	Rail, silver, cut to size						8.33				A
1012	Rail, silver in 6 metre lengths only						7.44				A
1012	Rail, silver, cut to size						8.10				A
1012	Rail, bronze in 6 metre lengths only						11.82				A
1012	Rail, bronze, cut to size						12.50				A
1021	Rail, silver in 5 metre or 6 metre lengths only						5.41				A
1021	Rail, silver, cut to size						5.93				A
1021	Rail, white, bronze, gold in 6 metre lengths only						11.65				A
1021	Rail, white, bronze, gold, cut to size						12.16				A
1025	Rail, silver in 5 metre or 6 metre lengths only						5.41				A
1025	Rail, silver, cut to size						5.93				A
1025	Rail, white, bronze, gold in 6 metre lengths only						11.65				A
1025	Rail, white, bronze, gold, cut to size						12.16				A
1080	Rail, silver in 5 metre or 6 metre lengths only						7.22				A
1080	Rail, silver, cut to size						7.89				A
1080	Rail, white in 5 metre or 6 metre lengths only						7.61				A
1080	Rail, white, cut to size						8.48				A
1080	Rail, bronze, gold, black, cream in 6m. lengths only						15.59				A
1080	Rail, bronze, gold, black, cream cut to size						16.31				A
1082	Rail, silver in 5 metre or 6 metre lengths only (System 3000)						11.88				A
1082	Rail, silver, cut to size (System 3000)						13.30				A
1082	Rail, white, in 5 metre or 6 metre lengths only (System 3000)						14.04				A
1082	Rail, white, cut to size (System 3000)						14.51				A
1082	Rail, bronze, gold and black in 6 metre lengths only (System 3000)						23.23				A
1082	Rail, bronze, gold and black, cut to size (System 3000)						24.63				A
1085	Rail, silver in 4 metre lengths only						15.74				A
1085	Rail, silver, cut to size						18.19				A

Price Index for Rails & Parts

All prices shown
exclude V.A.T.

Product	Description	Unit Prices					Per Metre Price				Ctgy
		Each	Per 10	Per 100	Other Qty	Price	1m	100m	Other Lgth	Price	
1090	Rail, silver in 5 metre or 6 metre lengths only						6.19				A
1090	Rail, silver, cut to size						6.72				A
1090	Rail, white in 5 metre or 6 metre lengths only						6.40				A
1090	Rail, white, cut to size						7.06				A
1090	Rail, bronze in 6 metre lengths only						12.95				A
1090	Rail, bronze, cut to size						13.89				A
1105	Spacer			30.99							A
11210C	Counter sunk screw No.10, 37mm/1 1/2"			18.22							A
1128C	Counter sunk screw No.8, 37mm/1 1/2"			20.84							A
1128R	Round head screw No.8, 37 mm/1 1/2"			20.84							A
1148C	Counter sunk screw No.8, 31mm/1 1/4"			15.75							A
1148R	Round head screw No.8, 31mm/1 1/4"			18.69							A
1200	Rail, white, in 5/6 metre lengths, outers of 10 lengths only						6.56				A
1200	Rail, silver in 6m lengths only						6.20				A
1200	Rail, black, gunmetal, in 6m lengths only, anthracite brushed aluminium and chrome effect in 4m lengths only						11.53				A
1221	Rail, white, in 5/6 m lengths, outers of 10 lengths only						7.23				A
1225	Rail, white, in 5/6 m lengths, outers of 10 lengths only						6.44				A
1280	Rail, white, in 5/6 m lengths, outers of 10 lengths only						10.30				A
1348R	Round head screw No.8, 44mm/1 3/4"			22.96							A
2004	Bottom weight bar (4 metre length max) 40mm						16.77				A
2006	Aluminium weight bar (4 metre length max) 28mm						11.97				A
2032	Tape spool cassette	9.69	92.29	876.81	250						A
2046	Drive pulley	1.76									A
2047	Drive sleeve	3.14									A
2048	Bead chain							233.22			A
2049	Gear drive	23.02	219.36	1993.56							A
2059	Safety clip		8.25								A
2075	Rod cover with ring	1.19	11.35	108.06							A
2081	Take up reel, 2120/2050 systems	10.27	92.16								A
2091	Endcover	0.95	8.83	84.05							A
2093	Ring		2.17	20.61							A
2094	Small cord guide/endstop	0.85	7.72								A
2101	Cord guide		20.71	189.49							A
2101	Cord guide, Euroslot sachet of 2	4.88									A
2103T	Transparent loop tape							133.59			A
2104	Cleat, white nylon	2.85	25.91								A
2109	Bottom ring		5.94	54.05							A
2109	Bottom ring, Euroslot sachet of 2	1.95									A
2111	Hexagonal bar								6m	77.51	A
2111	Hexagonal bar, outer of 50 lengths								6m	58.12	A
2116	Velcro profile								5m	80.73	A
2116	Velcro profile, outer of 40 lengths								5m	72.66	A
2125	Roller guide	5.40	51.19	460.64							A
2131	Short end-cover	1.55	13.88								A
2135	Steel rod								3m	7.13	A
2136	Tubular tape							155.58			A
2136CR	Tubular tape, cream							159.76			A
2143	Cord connector	1.53	13.70								A
2144	Cross rail								4m	45.82	C
2145	Glider, wide channel for side rails	1.14	10.94								C
2147	Cord lock	6.84	64.93								A
2151	Rail, silver in 6 metre lengths only						89.87				C
2151	Rail, silver, cut to size						98.89				C
2153	Tape holder	0.95									C
2156	Drive shaft						11.62		6m	63.35	C
2160	Motor	927.90									C
2162	Tape diverter	3.48									C
2164	Ring tape								200m	509.96	A
2164T	Transparent ring tape								50m	127.49	A
2179	Endcover for 2211	1.32	12.39								A
2182	Sleeve and pin, pair				2	11.65					C

Price Index for Rails & Parts

All prices shown
exclude V.A.T.

Product	Description	Unit Prices					Per Metre Price				Ctgy
		Each	Per 10	Per 100	Other Qty	Price	1m	100m	Other Lgth	Price	
2187	Connector	37.48									C
2189	Gear, system 2190	151.34									C
2191	Rail, silver, 6 metre lengths only						18.98				C
2191	Rail, silver, cut to size						20.87				C
2191	Rail, white, 6 metre lengths only						20.17				C
2191	Rail, white, cut to size						22.18				C
2191	Rail, bronze, and black in 6 metre lengths only						29.79				C
2191	Rail, bronze, and black cut to size						32.75				C
2192	Belt drive endpiece set	10.78									C
2192W	Belt drive endpiece set, white	11.28									C
2193	Belt return set	10.78									C
2193W	Belt return set, white	11.02									C
2196	Lead weight tape								50m	124.68	A
2197	Wooden acorn	2.12									A
2198	Pencil pleat tape								50m	250.48	A
2199	Oval wooden weight section								3m	13.63	A
2211	Velcro profile						29.69		6m	161.84	A
2216	Cord								1000m	230.47	A
2221	Velcro tape								100m	460.96	A
2230	Set, white, grey	22.63									C
2242	Connector	28.88									C
2248	Cross rod								6m	74.13	C
2255	Adjustable brake	14.69	133.17								C
2265	Cord lock system	11.56	105.01								A
2269	Tab top clips hook		19.95	181.29							A
2321	Profile, white in 6 metre lengths only						21.89				A
2322	Pin	1.00									A
2323	Shell	1.16									A
2325	Cover	9.14									A
2326	Drive Case 4.1	34.49									A
2327	Adaptor	1.08									A
2328	Adaptor	1.08									A
2329	Adaptor	1.69									A
2333	Wheel for plastic chain	1.61									A
2334	White sleeve for plastic chain	1.61									A
2335	Drive Case 1:1	7.38									A
2336	Support	1.38									A
2337	Endcover	2.15									A
2338	Wire Guides	1.61									A
2339	Cover	2.68									A
2341	Wheel for steel chain	1.62									A
2343	Wall/Ceiling bracket	3.38									A
2344	Grey sleeve for metal chain	1.69									A
2363	Wall/ceiling bracket for 2350	3.44									A
2471	Bottom weight 5/127mm	0.91		86.94							C
2473	Bottom weight 3_/89mm	0.72		67.82							C
2479	Link chain 5/127mm						0.85		500m	378.83	C
2481	Link chain 3_/89mm						0.85		500m	378.83	C
2539	Touch and close pile section							154.66	25m	42.96	A
2601	Profile only,white						21.53				C
2601	Profile only, silver						21.02				C
2604	Guide	4.71									C
2605	Top clip 127mm each, white	0.35		30.67							C
2606	Reducing Top clip 127mm for 2810	0.67		63.17							C
2607	Reducing Top clip 89mm for 2810	0.67		63.17							C
2608	Endstop for 2601	11.11									C
2610	Endstop	1.71									C
2611	Stopper	1.54									C
2612	Brake	2.82									C
2613	Connector	12.69									C
2614	Recess Profile (suspended ceilings)						20.85				C
2615	Recess profile						16.49				C

Price Index for Rails & Parts

All prices shown
exclude V.A.T.

Product	Description	Unit Prices				Per Metre Price				Ctgy
		Each	Per 10	Per 100	Other Qty	Price	1m	100m	Other Lgth	
2616	Bracket, white	3.49								C
2616	Bracket, silver	1.91								C
2618	Shaft	0.84								C
2620	Pilot Runner	5.88								C
2623	Rotation element (123mm)	2.06								C
2624	Rotation element (101mm)	2.06								C
2625	Rotation element (89mm)	2.06								C
2645	Face Fix bracket for 2640/2650	19.83								C
2746	Detachable crank handle 150cm	73.49								C
2746	Detachable crank handle extra 10cm	1.42								C
2747	Crank handle 150cm	58.74								C
2747	Crank handle extra 10cm	1.42								C
2754	Detachable hood	15.40								C
2755	Universal joint for crank 2746	20.58								C
2759	Crossrail, 0.13mm							4m	29.04	C
2813	Top clip 89mm, white	0.35		30.67						C
2821	Spacer (65mm)	0.68								C
2826	Chain connector	1.09	10.38							A
2849	PVC top clip			39.49						C
2865	Twin connector	1.42								C
2872	Operating chain, white					2.63		250m reel	649.92	C
3003	Clamp		37.24	335.14						C
3004	Clamp		11.68	105.18						A
3008	Connecting bridge	9.46								A
3016	Endstop	0.41		30.82						A
3016	Endstop, Euroslot sachet of 2	1.60								A
3017	Endstop	0.73		65.99						A
3019	Special 1011/12 screw 12mm/ 1/2"			19.27						A
3020	Hook			36.65						A
3021	Raised head No.6 for 1012 concrete fixing support 31mm/1 1/4"			19.86						A
3025	Special 1011/12 screw 19mm/ 3/4"			27.53						A
3030	Pilot runner	1.70		148.87						A
3032	Spring stop		6.78	60.93						A
3033	Clamp for 2900	2.21	19.92							C
3041	Clamp	1.44	12.88							A
3045	Metal overlap	3.51	31.54							A
3055	Hook	0.50	4.81							A
3056	Tape centralizer		9.44							A
3063	Connecting bridge 1011	2.49	20.59							A
3064	Connecting bridge 1012	2.49	20.59							A
3065	L' bracket A, silver, white with 1 rivetted clamp	7.33								C
3066A	T' bracket A, silver, white with 1 rivetted clamp	34.91								A
3066B	T' bracket A, silver, white with 2 rivetted clamps	35.20								A
3067	Connecting bridge	3.30								A
3068A	Loop tape							250m Reel	523.08	A
3070	Twist eye endstop	0.62	5.47	48.90						A
3071	Screw twist endstop	0.79	7.54							A
3073	Bottom tape adjuster	0.32	2.41							A
3090	Cord						115.33			A
3090A	Cord							500m	546.77	A
3091	Cord, black						161.71			A
3096	Connecting bridge 1090	5.23	47.09							A
3112	Clamp for 1012			35.63						A
3113	5cm spacer 1090		17.41	156.71						A
3115	7cm spacer 1090		22.93	206.19						A
3133	Plastic bracket cover, black, white, silver, cream, gunmetal, classic gold, steel grey, bronze, antique bronze, sand, taupe	2.30	21.17	194.47						A
3133	Plastic bracket cover, chrome and oak	4.11	38.11	350.02						A
3133L	Long Extension Bracket Cover White	2.93	26.40	249.35						A
3134	2 Extension brackets, silver, white and brown for std systems	3.11	28.62	271.82						A
3134/2	2 Extension brackets, silver, white, cream, classic gold, gunmetal, black, steel grey, bronze, antique bronze, sand, taupe (for poles)	4.05	37.55	345.12						A

Price Index for Rails & Parts

All prices shown
exclude V.A.T.

Product	Description	Unit Prices					Per Metre Price				Ctgy
		Each	Per 10	Per 100	Other Qty	Price	1m	100m	Other Lgth	Price	
3134 B2	2 Extension brackets, top fix for silver, white, cream, classic gold, gunmetal, black, steel grey, bronze, antique bronze, sand, taupe (for poles)	6.83	67.00								A
3134 B2	2 Extension brackets, top fix for chrome effect and oak (for poles)	9.64	95.05								A
3134/2	2 Extension brackets, chrome effect and oak (for poles)	6.86	66.90	622.39							A
3135	3 Extension brackets, silver, white and brown for standard systems	3.56	34.78	330.41							A
3135/2	3 Extension brackets, silver, white, cream, classic gold, gunmetal, black, steel grey, bronze, antique bronze, sand, taupe (for poles)	4.82	44.65	410.31							A
3135/2	3 Extension brackets, chrome effect and oak (for poles)	7.28	71.10	661.28							A
3136	4 Extension brackets, silver or white for standard systems	3.84	36.99	351.46							A
3136/2	4 Extension brackets, silver, white, cream, classic gold, gunmetal, black, steel grey, bronze, antique bronze, sand, taupe (for poles)	5.68	52.54	482.88							A
3136/2	4 Extension brackets, chrome effect and oak (for poles)	9.24	90.23	839.32							A
3137	5 Extension brackets, silver or white for standard systems	6.02	57.23								A
3137	5 Extension brackets, brown for standard systems	8.95	84.90								A
3138	6 Extension brackets, silver or white for standard systems	6.16	58.49								A
3138	6 Extension brackets, brown for standard systems	9.24	88.43								A
3139	7 Extension brackets, silver or white for standard systems	6.82	64.78								A
3139	7 Extension brackets, brown for standard systems	11.88	112.72								A
3135/2616	Extension bracket complete with 2616 bracket and M4 screw silver	5.49	52.20								A
	Extension bracket complete with 2616 bracket and M4 screw white	7.07	67.19								A
3136/2616	Extension bracket complete with 2616 bracket and M4 screw silver	5.77	54.82								A
	Extension bracket complete with 2616 bracket and M4 screw white	7.35	69.81								A
3137/2616	Extension bracket complete with 2616 bracket and M4 screw silver	7.96	75.57								A
	Extension bracket complete with 2616 bracket and M4 screw white	9.53	90.56								A
3138/2616	Extension bracket complete with 2616 bracket and M4 screw silver	8.09	76.84								A
	Extension bracket complete with 2616 bracket and M4 screw white	9.67	91.82								A
3139/2616	Extension bracket complete with 2616 bracket and M4 screw silver	8.75	83.13								A
	Extension bracket complete with 2616 bracket and M4 screw white	10.33	98.11								A
3175	Universal nylon bracket for 1090/1200 system	1.11	10.30	61.53							A
3176	Top fix bracket 1090/1200, white	1.11	10.30	61.53							A
3208A	Intermediate pulley, 3000, grey and white	31.43	286.17								A
3208A	Intermediate pulley, 3000, brown, black, gold	35.67	331.30								A
3213	Adjustable carrier 3000	2.38		210.73							A
3231	Endfix bracket 3000	8.26	78.34								A
3239	Extension bracket, silver or white	13.20									C
3242	Nylon overlap	2.57	22.66	181.59							A
3242	Nylon overlap, Euroslot sachet of 1	3.29									A
3271	Adjustable bracket base, silver	9.93									A
3271	Adjustable bracket base, white	15.69									A
3271	Adjustable bracket base, brown	11.45									A
3272	Adjustable bracket arm, silver	3.31									A
3272	Adjustable bracket arm, white	9.47									A
3272	Adjustable bracket arm, brown	4.83									A
3273	Adjustable bracket arm, silver	4.30									A
3273	Adjustable bracket arm, white	10.86									A
3273	Adjustable bracket arm, brown	5.83									A
3274	Adjustable bracket arm, silver	4.30									A
3274	Adjustable bracket arm, white	10.33									A
3274	Adjustable bracket arm, brown	5.83									A
3275	7.7cm - 10.7cms, adjustable extension brackets, silver	13.37									A
3275	7.7cm - 10.7cms, adjustable extension brackets, white	25.29									A
3275	7.7cm - 10.7cms, adjustable extension brackets, brown	14.90									A
3276	10cm - 13cm adjustable extension brackets, silver	14.37									A
3276	10cm - 13cm adjustable extension brackets, white	26.68									A
3276	10cm - 13cm adjustable extension brackets, brown	17.41									A
3277	13cm - 16cm adjustable extension brackets, silver	14.61									A
3277	13cm - 16cm adjustable extension brackets, white	26.15									A
3277	13cm - 16cm adjustable extension brackets, white	17.70									A
3275/3044	Extension bracket, with clamp, silver	12.91									C
3275/3044	Extension bracket, with clamp, white	22.84									C
3276/3044	Extension bracket, with clamp, silver	13.74									C
3276/3044	Extension bracket, with clamp, white	24.00									C
3277/3044	Extension bracket, with clamp, silver	13.74									C
3277/3044	Extension bracket, with clamp, white	23.56									C

Price Index for Rails & Parts

All prices shown
exclude V.A.T.

Product	Description	Unit Prices				Per Metre Price				Ctgy
		Each	Per 10	Per 100	Other Qty	Price	1m	100m	Other Lgth	
3275/3825	Extension bracket, with clamp, silver	11.81								C
3275/3825	Extension bracket, with clamp, white	21.74								C
3275/3825	Extension bracket, with clamp, brown	13.07								C
3276/3825	Extension bracket, with clamp, silver	12.63								C
3276/3825	Extension bracket, with clamp, white	22.89								C
3276/3825	Extension bracket, with clamp, brown	15.17								C
3277/3825	Extension bracket, with clamp, silver	12.89								C
3277/3825	Extension bracket, with clamp, white	22.45								C
3277/3825	Extension bracket, with clamp, brown	15.48								C
3288	Endpiece set 3000, grey	23.91			25	552.54				A
3288	Endpiece set 3000, white	26.39			25	588.47				A
3288	Endpiece set 3000, gold/black/brown	29.29			25	676.64				A
3289	Endpiece set, grey	27.34								A
3289	Endpiece set, white	29.09								A
3311	Cord				100m	67.99				A
3340	Cord weight, white	5.10	45.98	413.76						A
3340	Cord weight, Grey/Chrome	15.46	146.85							A
3511	Glider			10.03	25000	2012.18				A
3532	Glider			21.25	5000	851.88				A
3533	Glider			11.24	25000	2248.12				A
3533	Glider, sachets of 25 x 25	69.45								A
3533	Glider, Euroslot sachets of 25	3.68								A
3533/6146	Glider with hook				20	8.73				A
3534	Glider in strip form				1000	96.16				A
3548	Retrofit glider				25	5.19				A
3548	Retrofit glider			18.95	1000	189.04				A
3562	Standard tape						194.89			A
3570	Rotating glider		2.47	21.60						A
3571	Hook			9.90	35000	2908.16				A
3571	Hook, sachet of 25 x 25	66.11								A
3571	Hook, Euroslot sachet of 25	3.36								A
3579	Glider/hook	0.20	1.88	17.97						A
3579	Glider/hook, Euroslot sachet of 25	5.49								A
3580	Glider/hook			39.93	5000	1904.85				A
3582	Plastic hook			8.79						A
3582	Plastic hook, sachets of 25 x 25	73.84			625	73.82				A
3582	Plastic hook, outer 20000				20000	1561.58				A
3582	Plastic hook, outer 1000				1000	82.20				A
3582	Plastic hook, Euroslot sachets of 25				25	3.09				A
3599	2 prong hook			13.78	25000	2625.91				A
3599	2 prong hook, sachets of 25 x 25	105.36								A
3599	2 prong hook, Euroslot sachets of 25	4.53								A
3600	Picture hanging set	18.60								A
3602	Wall support 1080, grey	4.02	38.09							A
3602	Wall support 1080, white	4.22	38.25							A
3603	Top fix bracket, white	1.50	13.58	123.66						A
3603	Top fix bracket, Euroslot sachets of 2, white	3.89								A
3604	Nylon Corner Piece (White Only)	2.65								A
3605	Endcover 1080, white	2.08	18.92	180.19						A
3606	Snap fastener 1080	1.06	8.26							A
3610S	Hanger rod assembly 2'	20.27								A
3610S	Hanger rod assembly 3'	22.56								A
3610S	Hanger rod assembly 4'	27.28								A
3611	Ceiling stud 1085	1.83								A
3612	Sleeve for 3610	4.08								A
3615	Clamp/insert for pelmet system	0.91								A
3616	Ceiling support	14.62								A
3618	Metal wall support	3.48	31.58							A
3620	Connecting bridge	11.06	103.69							A
3626	Return fixing bracket	3.52	31.67							A
3630	White universal nylon bracket	1.44	11.40	103.72						A
3630	Universal nylon bracket, white, black Euroslot sachet of 2	3.74								A

Price Index for Rails & Parts

All prices shown
exclude V.A.T.

Product	Description	Unit Prices					Per Metre Price				Ctgy
		Each	Per 10	Per 100	Other Qty	Price	1m	100m	Other Lgth	Price	
3630	Universal nylon bracket, black, brown,gold	1.60	14.39								A
3634	Height adjuster	3.23									A
3637	Cord							58.61			A
3637A	Cord								500m	263.85	A
3638	Re-inforced corner piece, grey, white	2.42	22.08	201.15							A
3639	Hanger rod assembly complete	18.69									A
3639	Hanger rod assembly complete, per extra foot	2.17									A
3648	Eyelet for 3638	0.40	3.48	31.18							A
3652	Wall support, grey	5.03									A
3655	Long universal bracket	2.43	23.19	211.03							A
3657	Connecting bridge 3600	3.67									A
3660	Extra long universal bracket	3.04									A
3660	Extra long universal bracket, Euroslot sachet of 1	3.96									A
3663	Profile hook	2.80									A
3666	Cord Tidy	0.98	8.98	81.58							A
3667	Endcover/stop, white, grey	1.13	10.91	104.08							A
3667	Endcover/stop, white, grey, Euroslot sachets of 2	3.17									A
3697	Hanger rod only, tapped for 1085								61cm	9.64	A
3697	Hanger rod only, tapped for 1085								91cm	12.19	A
3697	Hanger rod only, tapped for 1085								122cm	15.05	A
3699	Track insert	2.14									A
3735	Cord tensioner, with spring, white	18.20									A
3799	Small Cord tensioner, white	7.93									A
3802	Connecting bridge	12.20									A
3825	Clamp		17.34	165.89							A
3826	Top fix bracket	1.14	10.40	93.62							C
3832	Twist clamp	2.19									A
3833A	Intermediate pulley, white	44.93									A
3833A	Intermediate pulley, colours (black, gold, grey, brown)	49.13									A
3836	Face fix bracket, white	2.36									A
3841	Rail, silver in 6 metre lengths only						13.89				A
3841	Rail, silver, cut to size						15.43				A
3841	Rail, white in 6 metre lengths only						15.42				A
3841	Rail, white, cut to size						17.12				A
3841	Rail, bronze, gold and black in 6 metre lengths only						27.40				A
3841	Rail, bronze, gold and black, cut to size						28.92				A
3842	Endcap for 3840 Hand, white.	3.77									A
3842	Endcap for 3840 Hand, silver, gold, black, bronze	5.30									A
3845	Endpiece set, white/grey	14.98									A
3845	Endpiece set, gold	18.47									A
3845	Endpiece set, black/brown	20.80									A
3846	Endpiece set, white, grey	20.71									A
3914	Bracket for return profile	12.38									A
3915	Endpiece set					20	339.02				A
3915	Endpiece set					50	763.12				A
3916	Pilot runner for multi-stack system	1.44	12.78								A
3917	Pilot runner	1.97		186.75							A
3922	Roller gliders in strip form, outer of 1000					1000	387.73				A
3922	Roller gliders in strip form, outer of 8000					8000	2678.93				A
3929A	Intermediate pulley	48.64	463.00								A
3932	Spring stop	0.70	6.66								A
3933	Click glider in strip form, outer of 1000					1000	246.35				A
3935	Overlap arm (System 3900)	18.31	174.43								A
3936	Overlap arm (System 3900)					20	184.68				A
3936A	Combination overlap with 'S' hook attachment 3949	12.39	117.97								A
3939	Pilot runner	1.67		160.07							A
3942	Intermediate stop	2.80	27.10								A
3947	Pair of magnetic gliders		56.24								A
3949	Combination for overlap 3936A and 3935A	2.64	25.18								A
3975	Overlap for pulling by hand (1290)	16.79	159.85								A
3982	Rail, white, available in 5 metre or 6 metre lengths in outers of 10 lengths only (System 3900)						16.12				A

Price Index for Rails & Parts

All prices shown
exclude V.A.T.

Product	Description	Unit Prices				Per Metre Price				Ctgy
		Each	Per 10	Per 100	Other Qty	Price	1m	100m	Other Lgth	
3984	Endcover for 1221/1225, white			108.16						A
3985	Endcover in white 1280			178.76						A
3986	Endcover for 1200, white, grey, dark grey, black			108.16						A
4221	Bottom weight bar, white, silver or black						16.06			C
4223	Plastic strip with adhesive 12mm						2.83			C
4226	Standard adhesive tape, 30mm						4.64			C
4241	Weight bar caps, white, black, grey	0.38								C
4245	Extension bracket	10.88								C
4845	Metal bead chain (2020/2120)							125m	413.51	A
4845BR	Metal bead chain, brass (2020/2120)							125m	777.75	A
5002	Right Hand Overlap arm	8.11								C
5003	Overlap arm straight (single stack)	4.69								C
5004	Overlap	8.16								C
5005	Master Carrier	2.25								A
5091	Motor Set	229.73								A
5092	Timer Set	58.40								A
5093	Infra Red Set including Handset/Receiver	84.25								A
5110	Mask	3.59								C
5112	Endstop	5.12								C
5114	Ceiling cover plate	23.45								C
5115	Connecting bridge	18.50								C
5117	Recess profile, silver						37.15			C
5117	Recess profile, white						37.15			C
5118	Wedge for recess profile	4.43								C
5120	Master carrier	3.97								C
5127	Safety Device	3.75								A
5130	Drive belt for 5400/2190/2195						10.30			C
5141	Rail, white, 6m length only						23.88			C
5152	Pulley wheel	3.63								A
5185	Motor Cover	12.36								C
5301	Rail, silver in 6 metre lengths only						41.28			C
5301	Rail, white in 6 metre lengths only						43.48			C
5302	Drive belt						16.59			C
5304	Drive set, white, grey	92.17								C
5310	Endset, return, white, grey	79.71								C
5312	Endstop	10.87								C
5317	Master carrier set	38.47								C
5318	Motor support	12.88								C
5319	Connecting bridge	28.88								C
5320	Clamp	3.96								C
5321	Master pilot	43.28								C
5360	Motor	2210.69								C
5670	Overlap	53.67								C
5682	Hood	12.69								C
5684	Connector	27.19								C
5736	Surface relay socket	124.68								C
5778	Special plug for cable 5779, pair				2					C
5779	4 core low voltage connecting cable						4.08			C
5782ST	Single Channel radio handset white	86.81								C
5784ST	Multi channel radio handset white	114.41								C
5806	Pilot runner	26.37								C
5809	Roller glider		89.20							C
5810	Profile						93.17			C
5811	Overlap	160.79								C
5813	Floor frame	1135.14								C
5814	Cable						23.91			C
5815	Cord guide return	220.30								C
5816	Cord guide	248.77								C
5824	Endstop	16.72								C
5829	2 hole fixing plate	8.24								C
5834	Double pilot	193.35								C
6003	Rail, white in 6 metre lengths only						30.07			C

Price Index for Rails & Parts

All prices shown
exclude V.A.T.

Product	Description	Unit Prices					Per Metre Price				Ctgy
		Each	Per 10	Per 100	Other Qty	Price	1m	100m	Other Lgth	Price	
6003	Rail, white, cut to size						31.57				C
6007	Endstop, silver	0.48	4.62								A
6007	Endstop, white	0.66	6.23								A
6021	Rail, white, in 5/6 metre lengths, outers of 10 lengths only						9.75				A
6024	Panel glide connecting bridge	10.53									C
6053	Spring stop	6.84	61.56								C
6063	Overlap	9.06	82.42	770.33							A
6063R	Overlap arm with rollers for 6120	15.67									A
6064	Screw twist endstop	1.10	9.36								A
6065	Twist eye endstop	0.97	8.87	81.64							A
6070	Cord 6200/6370							323.36			C
6079	Overlap	29.50									C
6083	Glider			18.95							A
6083	Glider, sachets of 25 x 25	133.59									A
6083	Glider, Euroslot sachets of 25	5.46									A
6086	Spring stop	1.61	15.14	137.53							A
6094	Roller glider with hook		26.53	252.46							A
6096	Strip gliders, outer 1000				1000	152.40					A
6098	Roller glider with eye		22.38	212.32							A
6098W	Roller glider with eye per Metre						48.89		50m	2322.10	A
6101	Rail, white in 4.5m, 4.75m, 5m, 5.25m, 5.5m, 6m, 6.75m lengths only						26.87				A
6101	Rail, silver in 4.5m, 4.75m, 5m, 5.25m, 5.5m, 6m, 6.75m, 7.5m lengths only						23.89				A
6101	Rail, black, 6m lengths only						23.66				A
6101	Rail, gunmetal, steel grey, bronze, antique bronze 6m lengths only						34.68				A
6101	Rail, chrome, 4m lengths only						50.74				A
6103	Rail, gunmetal, steel grey, bronze, antique bronze, sand, taupe in 6 metre lengths only Classic Gold max (4m)						37.33				A
6103	Rail, silver, white, cream, black in 6 metre lengths only						25.51				A
6103	Rail, chrome effect (4m max), oak, (5m max.)						55.36				A
6106	Rail, silver, white, cream, black in 6 metre lengths only						33.47				A
6106	Rail, gunmetal, steel grey, bronze, antique bronze, sand, taupe in 6 metre lengths only, classic gold (4m max)						45.99				A
6106	Rail, chrome effect (4m max), oak, (5m max.)						62.10				A
6110	Dustcover, white						2.65				A
6119	Set, black, white, silver, cream, gunmetal, classic gold, chrome, steel grey, bronze, antique bronze, sand, taupe and oak	44.30	376.54								A
6119F	Kit for use with corded with finials, metal.	49.53	470.55								A
6119F	Kit for use with corded with finials, oak, chrome effect	75.67	718.94								A
6122	Endstop			235.68							A
6124	Twist fixing plate	4.20									A
6137	Ceiling fix plate, single, silver	5.84									A
6137	Ceiling fix plate, single, white	6.40									A
6138	Ceiling fix plate, double, silver	6.50									A
6138	Ceiling fix plate, double, white	7.13									A
6138P	Ceiling support, black, white, cream, silver, gunmetal, classic gold, chrome effect, diva gold, steel grey, bronze, antique bronze, sand, taupe and oak	7.25	65.26								A
6138P/2	Ceiling support, black, white, silver, cream, gunmetal, classic gold, chrome effect, diva gold, steel grey, bronze, antique bronze, sand, taupe and oak for 6120	14.48	130.53								A
6141	Insert		20.52	189.01							A
6143	Glider			15.06	1000	140.65					A
6146	Hook			15.90	12	2.35					A
6147	Glider hook				20	10.16					A
6147	Glider hook				500	203.46					A
6147	Glider hook				9500	3236.66					A
6148	Glider (yellow)				1000	226.25					A
6149	Lead glider (blue)			55.62							A
6160	Track insert	13.79									A
6165	Intermediate Pulley for 6120, black, cream, silver, classic gold, gunmetal, chrome, white, diva gold, steel grey, bronze, antique bronze, sand, taupe, oak	33.11	298.04								A
6175	Mini hanger, silver	19.95									A
6175	Mini hanger, white	22.06									A

Price Index for Rails & Parts

All prices shown
exclude V.A.T.

Product	Description	Unit Prices				Per Metre Price				Ctgy	
		Each	Per 10	Per 100	Other Qty	Price	1m	100m	Other Lgth		Price
6175	Mini hanger, black and steel grey	28.47								A	
6187	Dummy ceiling support sleeve, silver	7.25								A	
6187	Dummy ceiling support sleeve, white	8.38								A	
6188	Ceiling support, 50mm complete with stud 6193 and grub screw, silver	12.20								A	
6188	Ceiling support, 50mm complete with stud 6193 and grub screw, white	13.45								A	
6188	Ceiling support, 50mm complete with stud 6193 and grub screw, gold	15.05								A	
6188	Ceiling support, 50mm complete with stud 6193 and grub screw, chrome effect	19.07								A	
6190	Hanger rod assembly, complete including 6192 ceiling support and 6191 rod 61 cm (2') silver	25.89								A	
6190	Hanger rod assembly, complete including 6192 ceiling support and 6191 rod 61 cm (2') gold	31.18								A	
6190	Hanger rod assembly, complete including 6192 ceiling support and 6191 rod 61 cm (2') white	28.65								A	
6190	Hanger rod assembly, complete including 6192 ceiling support and 6191 rod 61 cm (2') other powder coated colours	34.69								A	
6190	Hanger rod assembly, complete including 6192 ceiling support and 6191 rod 61 cm (2') chrome effect	40.95								A	
6190	Hanger rod assembly, complete including 6192 ceiling support and 6191 rod 91 cm (3') silver	29.78								A	
6190	Hanger rod assembly, complete including 6192 ceiling support and 6191 rod 91 cm (3') gold	35.89								A	
6190	Hanger rod assembly, complete including 6192 ceiling support and 6191 rod 91 cm (3') white	32.12								A	
6190	Hanger rod assembly, complete including 6192 ceiling support and 6191 rod 91 cm (3') other powder coated colours	37.23								A	
6190	Hanger rod assembly, complete including 6192 ceiling support and 6191 rod 91 cm (3') chrome effect	50.59								A	
6191	Hanger tube, silver						12.86			A	
6191	Hanger tube, gold						16.16			A	
6191	Hanger tube, chrome effect						32.11			A	
6191	Hanger tube, white						14.30			A	
6192	Ceiling support, 100mm complete with stud 6193 and 2 grub screws, silver	15.89								A	
6192	Ceiling support, 100mm complete with stud 6193 and 2 grub screws, gold	19.67								A	
6192	Ceiling support, 100mm complete with stud 6193 and 2 grub screws, white	17.41								A	
6192	Ceiling support, 100mm complete with stud 6193 and 2 grub screws, chrome effect	24.77								A	
6193	Stud for ceiling support	2.36								A	
6194	Insert	2.19								A	
6197	Hanger joint sleeve, silver	14.65								A	
6197	Hanger joint sleeve, white	16.12								A	
6199	Internal connecting bridge	10.03								A	
6203	Connecting bridge	15.80								C	
6206	Endpiece set, grey	122.15								C	
6209	Clamp	6.67	63.35							C	
6210	Rail, silver in 4 metre, 5 metre and 6 metre lengths only						31.52			C	
6210	Rail, silver, cut to size						34.38			C	
6214	Adjustable pilot	9.46								C	
6224	Nylon clamp	5.73								C	
6226	End support	5.12								C	
6227	Master runner	9.46								C	
6228	Double fixing plate	5.21								C	
6230	Mask	15.58								C	
6243	Rail, white in 6 metre lengths only						9.73			A	
6268	Hanger for recess profile 2748 or profile 2948	9.04								C	
6283	Roller glider		13.89	131.78						A	
6288	Plastic overlap arm	2.87	25.95	233.42						A	
6290	Rail, White, in 5/6m lengths, outers of 10 lengths only						5.94			A	
6345	Wave glider-cord, 60mm pitch								50	695.29	A
6346	Wave glider-cord, 80mm pitch								50	529.32	A
6349	Wave curtain tape							232.36	50	116.18	A
6354	Pilot runner for set 6119 (System 6120)	4.98	47.34								A
6363	Wave Iron-on hemming tape						1.66	165.43			A
6364	Extension arm	4.04	36.38								A
6365	Hanger	3.37	30.32								A

Price Index for Rails & Parts

All prices shown
exclude V.A.T.

Product	Description	Unit Prices					Per Metre Price				Ctgy
		Each	Per 10	Per 100	Other Qty	Price	1m	100m	Other Lgth	Price	
6366	Draw rod carrier	6.38	57.44								A
6367	Master carrier	2.02	18.19								A
6368	Carrier	2.02	18.19								A
6369	Insert for face fixing 6370	4.07									
6371	Rail, silver in 4 metre, 5 metre and 6 metre lengths only						26.06				C
6371	Rail, silver, cut to size						30.13				C
6376	Connecting bridge	13.57	128.92								C
6377	Endpiece set, grey	32.62	310.68								C
6398	Clip	0.79	7.13								C
6501	V-hanger, silver	60.61			metre drop	22.53					A
6501	V-hanger, white	66.68			metre drop	24.77					A
6503	Wall bracket complete, white, 25mm long with 50mm projection	12.59									A
6503	Wall bracket complete, silver, 25mm long with 50mm projection	11.43									A
6503	Wall bracket complete, white, 50mm long with 50mm projection	16.77									A
6503	Wall bracket complete, silver, 50mm long with 50mm projection	14.80									A
6503	Wall bracket complete, white, 100mm long with 50mm projection	20.78									A
6503	Wall bracket complete, silver, 100mm long with 50mm projection	18.50									A
6503	Wall bracket complete, white, 200mm long with 50mm projection	29.07									A
6503	Wall bracket complete, silver, 200mm long with 50mm projection	26.21									A
6503	Wall bracket complete, white, 50mm long with 100mm projection	24.73									A
6503	Wall bracket complete, silver, 50mm long with 100mm projection	22.03									A
6503	Wall bracket complete, white, 100mm long with 100mm projection	34.26									A
6503	Wall bracket complete, silver, 100mm long with 100mm projection	31.15									A
6503	Wall bracket complete, white, 75mm long with 150mm projection	60.04									A
6503	Wall brackets complete, silver, 75mm long with 150mm projection	54.58									A
6511W	White cover for 6527	14.18									A
6512	Connecting bridge, silver	20.05									A
6512	Connecting bridge, white	22.82									A
6514M	T-junction, single, silver	9.26									A
6514M	T-junction, single, white	10.99									A
6519	Silver V-hanger rod						9.11				A
6521	External bridge 6103, silver	58.21									A
6521	External bridge 6103, white	62.04									A
6524A	Diagonal fixing support, silver	37.14									A
6524A	Diagonal fixing support, white	44.60									A
6525A	Double T-junction, silver	12.75									A
6525A	Double T-junction, white	14.74									A
6575	Cord tensioner	217.25									C
6578	Floor plate	142.00									C
6609	Wall support, grey,	6.62									A
6611	Endcover, grey	5.12									A
6611	Endcover, white	5.78									A
6620	Wall bracket 6103, grey	11.90	107.56								A
6625A	Fixing sleeve complete for V-hanger/diagonal support, silver	24.63									A
6625A	Fixing sleeve complete for V-hanger/diagonal support, white	27.80									A
6628	V-hanger track insert	7.92									A
6630	Endcover, white, black, grey, gold, chrome effect	3.93	36.30	333.56							A
6630	Endcover, gunmetal	6.81	64.57	613.44							A
6631	90° Connector piece 6103, grey	4.36									A
6631	90° Connector piece 6103, white	4.53									A
6632	Internal connecting bridge 6103	7.85									A
6635	Internal connecting bridge	16.27									A
6639	Track insert	2.32									A
6655	Wall Support	26.92									A
6663	Wall brackets connector plate complete	32.55									A
6666	Safety connecting bridge	41.52									A
6671	Washer insert for countersunk screw	0.94									A
6672	Cover for 6671	0.94									A
6675	Safety Device	34.00									A
6677	V-Hanger safety device	52.13									A
6739	Machine screw M4 6mm/ 1/4"			13.33							A
6748	Machine screw M4 8mm/ 5/16"			18.58							A

Price Index for Rails & Parts

All prices shown
exclude V.A.T.

Product	Description	Unit Prices				Per Metre Price				Ctgy
		Each	Per 10	Per 100	Other Qty	Price	1m	100m	Other Lgth	
6770	Locking pin	1.32								A
6771	Vine eye	1.53								A
6784	Machine screw for 6639			13.83						A
6789	Grub screw	0.22								A
6798	Machine screw M4 12mm/ 1/2"			19.49						A
6835A	Round head No. 4 screw 12mm/ 1/2"			7.47						A
6835B	Round head No. 4 screw 25mm/ 1"			12.88						A
6952	Magnetic handle holder	10.12								C
8003	Bottom bar (16mm)					34.07		5m		C
8004	Bottom bar (25mm)					35.25		5m		C
8005	Snap bracket	12.23								C
8012	Bottom bar clip (16mm)	0.51	4.74							C
8013	Bottom bar clip (25mm)	1.17	10.66							C
8014	Bottom bar endcover (16mm)	0.26	2.38							C
8015	Bottom bar endcover (25mm)	0.26	2.38							C
8027	Pulley endcover, left	1.98	19.07							C
8029	Pulley endcover, right	1.98	19.07							C
8031	Cord pulley	3.55	32.03							C
8033	Headrail endcap	3.70	33.24							C
8054	Fixing set	30.08								C
8104	Fixing bracket	2.83								C
8235	Wire base short	1.84								C
8236	Wire base long	1.93								C
8237	Wire holder	1.84								C
8249A	Locking ring	0.53								C
9020	Motor	757.10								C
9021	Motor with Radio reciever	901.43								C
9022	Motor with manual override	826.83								C
9023	Motor - Manual override with radio reciever	971.77								C
9040	Motor	681.39								C
9041	Motor with Radio reciever	811.29								C
9068	Single channel receiver	328.82								C
9090	Motor for 2650/2950	681.39								C
9091	Motor with receiver for 2650/2950	683.10								C
9121	Guide Set for 5400	52.58								C
9122	Guide Set for 5420	78.77								C
9123	Guide Set for 5420 (Manual Override)	106.68								C
9944	Single channel receiver, non latching	252.13								C
9945	Single channel receiver, latching	227.97								C
9946	Single channel wall switch	132.71								C
9947	Control unit DC 24V	148.98								C
9948	Single channel programmable wall switch with timer	331.80								C
9952	Hard wired timer switch	201.16								C
10002	Pulley Housing	6.94								A
10003	Pulley Housing Lid	1.20								A
10004	Locking Plate	0.31								A
10005	Motor Blanking Plate	0.46								A
10007	Floating Master Carrier	2.96								A
10008/9	Overlap Arm	2.00								A
10010	Stack Back Stop	2.69								A
10028	IR Sensor	28.16								A
10031	IR Transmitter	56.09								A
10040	Power supply set for 5200, 2650, 2950	104.82								C
10048	Power cable with plug for 5090, 5200, 2650 and 2950	6.12								C
10075	Lead weight					2.93				A
10076	Fabric weight white	7.23								A
10076/1	Fabric weight s/steel	6.87								A
10122	Profile cut to size, white, (for System 2700, 2 channel)					30.50				C
10123	Profile cut to size, white, (for System 2700, 3 channel)					49.21				C
10124	Profile cut to size, white, (for System 2700, 4 channel)					52.40				C
10125	Profile cut to size, white, (for System 2700, 5 channel)					56.91				C
10132	Profile cut to size, white (for System 2730, 2 channel)					24.05				C

Price Index for Rails & Parts

All prices shown
exclude V.A.T.

Product	Description	Unit Prices					Per Metre Price				Ctgy
		Each	Per 10	Per 100	Other Qty	Price	1m	100m	Other Lgth	Price	
10133	Profile cut to size, white (for System 2730, 3 channel)						37.75				C
10134	Profile cut to size, white (for System 2730, 4 channel)						51.46				C
10135	Profile cut to size, white (for System 2730, 5 channel)						65.16				C
10136	Top fix bracket for 2700, 2 channel profile only	2.98	28.30								C
10137	Top fix bracket for 2700, 3, 4 and 5 channel profiles	3.48	33.02								C
10140	Angle with screw	1.25									C
10142	Cover for 2 channel 2700 profile	1.83									C
10143	Cover for 3 channel 2700 profile	1.84									C
10144	Cover for 4 channel 2700 profile	1.89									C
10145	Cover for 5 channel 2700 profile	2.64									C
10146	Angle with screw	1.25									C
10148	Eyelet with screw	1.64									C
10150	Pilot runner with screw for 2700	3.28									C
10153	cord guide for 3 channel 2700 profile	6.65									C
10154	cord guide for 4 channel 2700 profile	6.71									C
10155	cord guide for 5 channel 2700 profile	7.90									C
10156	End stop with screw for 2700	2.59									C
10157	Wedge for 2700 recess profiles	1.75	16.67								C
10172	Recess profile, 2 channel, (for System 2700)						26.77				C
10173	Recess profile, 3 channel, (for System 2700)						26.77				C
10174	Recess profile, 4 channel, (for System 2700)						26.77				C
10175	Recess profile, 5 channel, (for System 2700)						26.77				C
10177	Connecting bridge for 2730	4.78									C
10180	Carrier assembled, flexible, (for system 2730)						34.53				C
10200	Roller for 2700 carrier	1.16									C
10230	Carrier assembled, white, (for system 2700)						32.16				C
10234	Glass weight bar 16mm	1.32									C
10252	2700 carrier end cover left	0.65									C
10253	2700 carrier end cover right	0.65									C
10269	Face fix bracket, 60mm, white, (for System 2730)	3.72	35.40								C
10270	Face fix bracket, 80mm, white, (for System 2730)	4.18	39.74								C
10271	Face fix bracket, 100mm, white, (for System 2730)	4.65	44.08								C
10272	Face fix bracket, 60mm, white, (for System 2730)	5.10	48.42								C
10281	Slot nut (for System 2730)		13.70								C
10297	Solar Sensor	311.70									C
10298	Sensor	281.66									C
10300	Single channel hand held remote	185.36									C
10302	5 + 1 channel hand held remote	185.36									C
10303	10 + 2 + 1 channel hand held remote	225.91									C
10333	End fix bracket for 2760, white	10.54									C
10334	End fix bracket for 2760, white	10.54									C
10335	End fix bracket for 2760, white	10.54									C
10356	Hanger rod for 2760 (max 1.5m drop) white	71.50									C
10357	V Hanger for 2760 (max 1.5m drop) white	115.85									C
10399	Design Fascia for 2760, white				per system	3.31	20.25				C
10430	Draw rod 50cm aluminium	7.83									C
10430	Draw rod 50cm white	8.50									C
10431	Draw rod 75cm aluminium	9.12									C
10431	Draw rod 75cm white	10.17									C
10432	Draw rod 100cm aluminium	10.33									C
10432	Draw rod 100cm white	11.62									C
10433	Draw rod 125cm aluminium	11.25									C
10433	Draw rod 125cm white	12.75									C
10434	Draw rod 150cm aluminium	12.09									C
10434	Draw rod 150cm white	13.77									C
10530	Chain for 4910 roller blind								150m	306.74	A
10534	Continuous headrail profile for 4900, 4910, 4960 silver, white (per m width)	16.04									C
10539	Optional click bracket for fixing continuous headrail 10534	3.82									C
10540	Spring side bracket for 4900 white	15.12									C
10541	Clutch side bracket for 4900 white	3.71									C
10542	Drive side bracket for 4910 white	3.24									C
10543	Click side bracket for 4910 white	3.02									C

Price Index for Rails & Parts

All prices shown
exclude V.A.T.

Product	Description	Unit Prices				Per Metre Price				Ctgy
		Each	Per 10	Per 100	Other Qty	Price	1m	100m	Other Lgth	
10545	Spring clutch set for 4910 system	53.98								C
10546	Spring clutch set for 4910 system	53.98								C
10547	Spring clutch set for 4910 system	60.34								C
10548	Spring clutch set for 4910 system	60.34								C
10549	Spring clutch set for 4910 system	73.34								C
10551	Spring clutch set for 4910 system	53.98								C
10552	Spring clutch set for 4910 system	53.98								C
10553	Spring clutch set for 4910 system	60.34								C
10554	Spring clutch set for 4910 system	60.34								C
10555	Spring clutch set for 4910 system	73.34								C
10562	Spring clutch set A for 4900 system	41.53								C
10563	Spring clutch set B for 4900 system	47.85								C
10564	Spring clutch set C for 4900 system	50.07								C
10565	Spring clutch set D for 4900 system	59.25								C
10566	Spring clutch set E for 4900 system	64.03								C
10567	Spring clutch set F for 4900 system	67.26								C
10574	Bracket cover for 4900, 4910, 4960 white	1.90								C
10575	Bracket cover for 4910, 4960 white	1.91								C
10632	Intermediate bracket cover for 4900, 4910, 4960 white	4.56								C
10633	Rectangular bottom bar for 4900, 4910, 4960 silver, white (per m width)	10.13								C
10634	Oval bottom bar for 4900, 4910, 4960 silver, white (per m width)	10.13								C
10635	End cover for rectangular bottom bar 10633 silver, white	1.11								C
10637	End cover for oval bottom bar 10634 silver, white	1.11								C
10639	End cover for round bottom bar 4221 silver, white	0.85								C
10645	Pull grip set	10.77								C
10697	Spring clutch set for 4910 system	73.34								C
10698	Spring clutch set for 4910 system	73.34								C
10699	Spring clutch set for 4910 system	73.34								C
10700	Spring clutch set for 4910 system	73.34								C
OHB40	Holdback with glass discus, lilac, red, amber, purple, white, complete with arm	85.65	792.47							A
OHB80	Vega square holdback complete with arm	55.60	515.74							A
OHB90	Vega circle holdback complete with arm	52.87	490.25							A
OM400	Glass discus midial, lilac, red, amber, purple, white complete with bracket	63.76	589.68							A
OM800	Vega square midial complete with bracket	36.95	343.67							A
OM900	Vega circle holdback complete with arm	34.67	322.42							A

Tools & Packaging

All prices shown
exclude V.A.T.

Product	Description	Unit Prices				Per Metre Price				Ctgy
		Each	Per 10	Per 100	Other Qty	Price	1m	100m	Other Lgth	
0513	Bending kit for 7103/7109 incl. fillers, blocks, arms and rings for system 1012	232.55								E
0538	Bending Kit for 7103/7109 incl fillers, blocks, arms and rings for system 3840	135.28								E
0539	Crimping tool	257.44								E
0545	Bending Kit for 7103/7109 incl. fillers, blocks,arms and rings for system 3900	273.26								E
0547	Bending block set (6103)	292.24								E
0548	Bending block set (2191)	301.24								E
0650	Bending kit for 7103/9 including filler set, rings and blocks for 1200	148.75								E
0679	Joining pliers for bead chain 4845	103.16								E
0997	Roller blind limit setting lead	27.58								E
5651	Programming Cable for 5400	66.47								E
7002	Rail protector	1.92								E
7004	Cording needle	1.53								E
7030	Slotting tool for small channel profiles	96.35								E
7037	Bending fillers 6100	30.88								E
7099	Hook for 2147									E
7100	Bending tool 1011/12/21/25/90	453.82								E
7103	Portable hand operated bending tool for 1080, 1200, 3000, 1280 and 3900, complete with sets of fillers	1001.92								E
7109	Portable electrically operated bending tool for 1080, 3000, 1280 and 3900 complete with sets of fillers	1178.25								E
7220	Slotting tool for 3900/1290	128.49								E
7223	Tongs for connector 2865	324.37								E
7230	Slotting tool for wide channel profiles	475.28								E
7432	Bending ring 15cm 1003 for 7103/9	52.53								E
7550	Centre tool	68.12								E
7802	Filler set 3840 for 7103/9, 200 cm	124.40								E
7803	Filler set 3900 for 7103/9, 200 cm	139.74								E
7803A	Filler set 3900 for 7103/9, 70 cm	73.06								E
7805	Filler set 3000 for 7103/9, 200 cm	221.23								E
7805A	Filler set 3000 for 7103/9, 70 cm	114.84								E
7806	Filler set 1080 for 7103/9, 200 cm	63.60								E
7806A	Filler set 1080 for 7103/9, 70 cm	30.97								E
7809	Filler set 1012 at 200cm for 7103/9 and 7100	62.43								E
7844	Filler set 1280 for 7103/9, 70cm	97.80								E
7844A	Filler set 1280 for 7103/9, 200cm	180.08								E
7845	Filler set 1200	64.73								E
7848	Filler set 1003 for 7103/9, 70cm	35.71								E
10400	Cord retainer	0.34								E
10480	Child safety device (4.5mm metal to metal bead chain)	8.00								E
10481	Child safety device (4.5mm plastic to metal bead chain)	8.00								E
10482	Child safety device (4mm metal to metal bead chain)	8.00								E
10536	Joining pliers for 10530 chain (4910) also require 10537	55.51								E
10537	Joining pliers for 10530 chain (4910) also require 10536	55.51								E
B5	Bending block for 6100	351.30								E
SF	Silicone fluid, litre	44.87								E
SL1080	Sleeving 1080, reel	24.01								E
SL1080W	Sleeving 1080W, reel	34.56								E
SL1090	Sleeving 1090, reel	30.07								E
SL1090W	Sleeving 1090W, reel	33.81								E
SL3000	Sleeving 3000, reel	37.84								E
SL3000W	Sleeving 3000W, reel	43.83								E
SLP	Sleeving plain 2 x 300 gauge, reel	16.22								E
HTSAL	Top s/a label			37.77						E
HBSAL	Bottom s/a label			26.99						E
CIAL	Colour indication s/a label (mixed - please specify)			4.05						E
CSIAL	Size indication s/a label (mixed - please specify)			4.05						E
HINL	Instruction leaflet			12.19						E
HCPA	38mm x 38mm acetate sleeving, roll									E
HWPE	White plastic endcaps				pair	1.60				E
CTSAL	Top s/a label			37.77						E
CBSAL	Bottom s/a label			33.27						E
CINL	Instruction leaflet			12.19						E
CCPA	35mm x 50mm acetate sleeving, roll									E
CWPE	White plastic endcaps				pair	1.60				E

Application Chart for Silent Gliss® Switches, Remote Control and Multiple Operation of Motorised Systems

Motor Type	Motor Number	Fixed Switch Only	Radio Control System 0450		Radio Control System 9940		Hard Wired Timer and Controls	System
			Hand Held Remotes	Wall Switches	Hand Held Remotes	Wall Switches & Light Sensors		
B	2160	0615/6/7/8/9	Remote 0915/0939 Receiver 0919	Wall Switch 0913/0914 Receiver 0919	Remote 10300/10302/10303 Receiver 9068/9945	Wall Switch 9946/9948 Light Sensor 10297/10298 Receiver 9068/9945	9952 0570	2195
B E	10322/ 10323/ 10522/ 10523	Motor 10322/ 10522 0615/6/7/8/9	Motor 10322/10522 Remote 0915/0939 Receiver 0919	Motor 10322/10522 Wall Switch 0913/0914 Receiver 0919	Motor 10323/10523 Remote 10300/10302/10303 Receiver Integrated	Motor 10323/10523 Wall Switch 9946/9948 Light Sensor 10297/10298 Receiver Integrated	n/a	2350
CC	9090/ 9091/ 9091EL	Motor 9090 0613	Motor 9091 Remote 0915/0939 Receiver Integrated	Motor 9091 Wall Switch 0913/0914 Receiver Integrated	Motor 9091EL Remote 10300/10302/10303 Receiver Integrated	Motor 9091EL Wall Switch 9946/9948 Light Sensor 10297/10298 Receiver Integrated	n/a	2650
CC	9090/ 9091/ 9091EL	Motor 9090 0613	Motor 9091 Remote 0915/0939 Receiver Integrated	Motor 9091 Wall Switch 0913/0914 Receiver Integrated	Motor 9091EL Remote 10300/10302/10303 Receiver Integrated	Motor 9091EL Wall Switch 9946/9948 Light Sensor 10297/10298 Receiver Integrated	n/a	2950
B E	10322/ 10323	Motor 10322 0615/6/7/8/9	Motor 10322 Remote 0915/0939 Receiver 0919	Motor 10322 Wall Switch 0913/0914 Receiver 0919	Motor 10323 Remote 10300/10302/10303 Receiver Integrated	Motor 10323 Wall Switch 9946/9948 Light Sensor 10297/10298 Receiver Integrated	0570 9952	4550
B E	10322/ 10323	Motor 10322 0615/6/7/8/9	Motor 10322 Remote 0915/0939 Receiver 0919	Motor 10322 Wall Switch 0913/0914 Receiver 0919	Motor 10323 Remote 10300/10302/10303 Receiver Integrated	Motor 10323 Wall Switch 9946/9948 Light Sensor 10297/10298 Receiver Integrated	0570 9952	4595
C	4960 LV	0631	n/a	n/a	n/a	n/a	n/a	4960 LV
B E	10320/ 10321	Motor 10320 0615/6/7/8/9	Motor 10320 Remote 0915/0939 Receiver 0919	Motor 10320 Wall Switch 0913/0914 Receiver 0919	Motor 10321 Remote 10300/10302/10303 Receiver Integrated	Motor 10321 Wall Switch 9946/9948 Light Sensor 10297/10298 Receiver Integrated	0570 9952	4960
B E	10523/ 10522	Motor 10522 0615/6/7/8/9	Motor 10522 Remote 0915/0939 Receiver 0919	Motor 10522 Wall Switch 0913/0914 Receiver 0919	Motor 10523 Remote 10300/10302/10303 Receiver Integrated	Motor 10523 Wall Switch 9946/9948 Light Sensor 10297/10298 Receiver Integrated	0570 9952	4870
B E	10326/ 10327	Motor 10326 0615/6/7/8/9	Motor 10326 Remote 0915/0939 Receiver 0919	Motor 10326 Wall Switch 0913/0914 Receiver 0919	Motor 10327 Remote 10300/10302/10303 Receiver Integrated	Motor 10327 Wall Switch 9946/9948 Light Sensor 10297/10298 Receiver Integrated	0570 9952	4880
D	5091	Standard	n/a	n/a	n/a	n/a	n/a	5090
D	5091	Standard	n/a	n/a	n/a	n/a	5093 IR	5090IR
D	5091	Standard	n/a	n/a	n/a	n/a	5092 Timer	5090TL
D	5091	Standard	n/a	n/a	n/a	n/a	5092 Timer	5090TC

Application Chart for Silent Gliss® Switches, Remote Control and Multiple Operation of Motorised Systems

Motor Type	Motor Number	Fixed Switch Only	Radio Control System 0450		Radio Control System 9940		Hard Wired Timer and Controls	System
			Hand Held Remotes	Wall Switches	Hand Held Remotes	Wall Switches & Light Sensors		
CC	9040 9041/ 9041EL	Motor 9040 0615/6/7/8/9	Motor 9041 Remote 0915/0939 Receiver Integrated	Motor 9041 Wall Switch 0913/0914 Receiver Integrated	Motor 9041EL Remote 10300/10302/10303 Receiver Integrated	Motor 9041EL Wall Switch 9946/9948 Light Sensor 10297/10298 Receiver Integrated	9952	5200
CC	9040 9041/ 9041EL	Motor 9040 0615/6/7/8/9	Motor 9041 Remote 0915/0939 Receiver Integrated	Motor 9041 Wall Switch 0913/0914 Receiver Integrated	Motor 9041EL Remote 10300/10302/10303 Receiver Integrated	Motor 9041EL Wall Switch 9946/9948 Light Sensor 10297/10298 Receiver Integrated	9952	5220
AA	5360	0565/6/7/8/9	Remote 0915/0939 Receiver 0918	Wall Switch 0913/0914 Receiver 0918	Remote 10300/10302/10303 Receiver 9068	Wall Switch 9946/9948 Light Sensor 10297/10298 Receiver 9068	9952	5300
BB	9020 9021/ 9021EL	Motor 9020 0615/6/7/8/9	Motor 9021 Remote 0915/0939 Receiver Integrated	Motor 9021 Wall Switch 0913/0914 Receiver Integrated	Motor 9021EL Remote 10300/10302/10303 Receiver Integrated	Motor 9021EL Wall Switch 9946/9948 Light Sensor 10297/10298 Receiver Integrated	9952	5400
BB	9020 9021/ 9021EL	Motor 9020 0615/6/7/8/9	Motor 9021 Remote 0915/0939 Receiver Integrated	Motor 9021 Wall Switch 0913/0914 Receiver Integrated	Motor 9021EL Remote 10300/10302/10303 Receiver Integrated	Motor 9021EL Wall Switch 9946/9948 Light Sensor 10297/10298 Receiver Integrated	9952	5420
B	5805	0615/6/7/8/9	Remote 0915/0939 Receiver 0919	Wall Switch 0913/0914 Receiver 0919	Remote 10300/10302/10303 Receiver 9068/9944/9945	Wall Switch 9946/9948 Light Sensor 10297/10298 Receiver 9068/9944/9945	n/a	5800
C	8060	0928/0937	Remote 0915/0939 Receiver 0907 (Pulse enabled)	Wall Switch 0913/0914 Receiver 0907 (Pulse Enabled)	Remote 10300/10302/10303 Receiver 9068/9947	Wall Switch 9946/9948 Light Sensor 10297/10298 Receiver 9068/9947	n/a	8250
C	8060	as supplied	Remote 0915/0939 Receiver 0907	Wall Switch 0913/0914 Receiver 0907	Remote 10300/10302/10303 Receiver 9068/9947	Wall Switch 9946/9948 Light Sensor 10297/10298 Receiver 9068/9947	n/a	8500
B	8605	0615/6/7/8/9	Remote 0915/0939 Receiver 0919	Wall Switch 0913/0914 Receiver 0919	Remote 10300/10302/10303 Receiver 9068/9944/9945	Wall Switch 9946/9948 Light Sensor 10297/10298 Receiver 9068/9944/9945	0570 9952	8600
B	9009	0615/6/7/8/9	Remote 0915/0939 Receiver 0919	Wall Switch 0913/0914 Receiver 0919	Remote 10300/10302/10303 Receiver 9068/9944/9945	Wall Switch 9946/9948 Light Sensor 10297/10298 Receiver 9068/9944/9945	0570 9952	8700
B	9009	0615/6/7/8/9	Remote 0915/0939 Receiver 0919 (Pulse enabled)	Wall Switch 0913/0914 Receiver 0919 (Pulse enabled)	Remote 10300/10302/10303 Receiver 9068/9944/9945	Wall Switch 9946/9948 Light Sensor 10297/10298 Receiver 9068/9944	0570	8800
B	0611	0613	Remote 0915/0939 Receiver 0919 (Pulse enabled)	Wall Switch 0913/0914 Receiver 0919 (Pulse enabled)	Remote 10300/10302/10303 Receiver 9068/9944/9945	Wall Switch 9946/9948 Light Sensor 10297/10298 Receiver 9068/9944	0570	8950



- A – Permanent supply with live/neutral switched control
- AA – As A, but cannot be connected directly by low voltage to an A motor
- B – 2 switch live/neutral/earth
- BB – As B, but can be connected directly in parallel to other BB motors without relays
- C – 24VDC with reverse polarity switching
- CC – 24VDC motor - volt free contact switching only
- D – 27VDC motor with dedicated controls
- E – 240V with integrated receiver
- 0570 – Volt-free Contact interface
- 9952 – Hard wired timer

Terms & Conditions of Trading with Silent Gliss Ltd

The buyer's attention is in particular drawn to the provisions of condition 12.4.

1. INTERPRETATION

1.1 The definitions and rules of interpretation in this condition apply in these conditions.

Buyer: the person, firm or company who purchases the Goods and/or Services from the Company.

Company: Silent Gliss Ltd.

Contract: any contract between the Company and the Buyer for the sale and purchase of the Goods and/or provision of Services, incorporating these conditions.

Delivery Point: the place where delivery of the Goods is to take place under condition 4.

Goods: any goods agreed in the Contract to be supplied to the Buyer by the Company (including any part or parts of them).

Services: any installation services agreed in the Contract to be supplied to the Buyer by the Company.

1.2 A reference to a particular law is a reference to it as it is in force for the time being taking account of any amendment, extension, application or re-enactment and includes any subordinate legislation for the time being in force made under it.

1.3 Words in the singular include the plural and in the plural include the singular.

1.4 A reference to one gender includes a reference to the other gender.

1.5 Condition headings do not affect the interpretation of these conditions.

2. APPLICATION OF TERMS

2.1 Subject to any variation under condition 2.3 the Contract shall be on these conditions to the exclusion of all other terms and conditions (including any terms or conditions which the Buyer purports to apply under any purchase order, confirmation of order, specification or other document).

2.2 No terms or conditions endorsed on, delivered with or contained in the Buyer's purchase order, confirmation of order, specification or other document shall form part of the Contract simply as a result of such document being referred to in the Contract.

2.3 These conditions apply to all the Company's sales and any variation to these conditions and any representations about the Goods and/or Services shall have no effect unless expressly agreed in writing and signed by the Sales Director of the Company. The Buyer acknowledges that it has not relied on any statement, promise or representation made or given by or on behalf of the Company which is not set out in the Contract. Nothing in this condition shall exclude or limit the Company's liability for fraudulent misrepresentation.

2.4 Each order or acceptance of a quotation for Goods and/or Services from the Company shall be deemed to be an offer by the Buyer to buy Goods and/or Services subject to these conditions.

2.5 No order placed by the Buyer shall be deemed to be accepted by the Company until a written acknowledgement of order is issued by the Company or (if earlier) the Company delivers the Goods to and/or carries out the Services for the Buyer.

2.6 The Buyer shall ensure that the terms of its order and any applicable specification are complete and accurate.

2.7 Any quotation is given on the basis that no Contract shall come into existence until the Company despatches an acknowledgement of order to the Buyer. Any quotation is valid for a period of 60 days only from its date, provided that the Company has not previously withdrawn it.

3. DESCRIPTION

3.1 The quantity and description of the Goods and/or Services shall be as set out in the Company's quotation or acknowledgement of order.

3.2 All samples, drawings, descriptive matter, specifications and advertising issued by the Company and any descriptions or illustrations contained in the Company's catalogues or brochures are issued or published for the sole purpose of giving an approximate idea of the Goods described in them. They shall not form part of the Contract and this is not a sale by sample.

4. DELIVERY

4.1 Unless otherwise agreed in writing by the Company, delivery of the Goods shall take place at the time the Goods have been unloaded at the delivery address nominated by the Buyer.

4.2 The Buyer shall take delivery of the Goods within 30 days of the Company giving it notice that the Goods are ready for delivery.

4.3 Any dates specified by the Company for delivery of the Goods or commencement or duration for performance of the Services are intended to be an estimate and time for delivery and/or performance shall not be made of the essence by notice. If no dates are so specified, delivery and/or performance shall be within a reasonable time.

4.4 Subject to the other provisions of these conditions the Company shall not be liable for any direct, indirect or consequential loss (all three of which terms include, without limitation, pure economic loss, loss of profits, loss of business, depletion of goodwill and similar loss), costs, damages, charges or expenses caused directly or indirectly by any delay in the delivery of the Goods or performance of the Services (even if caused by the Company's negligence), nor shall any delay entitle the Buyer to terminate or rescind the Contract unless such delay exceeds 60 days.

4.5 If for any reason the Buyer fails to accept delivery of any of the Goods when they are ready for delivery, or the Company is unable to deliver the Goods on time because the Buyer has not provided appropriate instructions, documents, licences or authorisations:

(a) risk in the Goods shall pass to the Buyer (including for loss or damage caused by the Company's negligence);

(b) the Goods shall be deemed to have been delivered; and

(c) the Company may store the Goods until delivery, whereupon the Buyer shall be liable for all related costs and expenses (including, without limitation, storage and insurance).

4.6 If the Company delivers to the Buyer a quantity of Goods of up to 5% more or less than the quantity accepted by the Company, the Buyer shall not be entitled to object to or reject the Goods or any of them by reason of the surplus or shortfall and shall pay for such goods at the pro rata Contract rate.

4.7 The Company may deliver the Goods by separate instalments. Each separate instalment shall be invoiced and paid for in accordance with the provisions of the Contract.

4.8 Each instalment shall be a separate Contract and no cancellation or termination of any one Contract relating to an instalment shall entitle the Buyer to repudiate or cancel any other Contract or instalment.

5. CANCELLATIONS AND RETURNS

The Buyer shall not be entitled to cancel any Contract or return Goods for refund without the prior written consent of the Company (which will be the absolute discretion of the Company) and payment of a handling charge of 20% of the Price in respect of ex stock items and in the case of made-to-measure items a percentage of the Price dependent upon the stage of manufacture reached at the point of cancellation.

6. NON-DELIVERY

6.1 The quantity of any consignment of Goods as recorded by the Company upon despatch from the Company's place of business shall be conclusive evidence of the quantity received by the Buyer on delivery unless the Buyer can provide conclusive evidence proving the contrary.

- 6.2 The Company shall not be liable for any non-delivery of Goods (even if caused by the Company's negligence) unless the Buyer gives written notice to the Company of the non-delivery within 7 days of the date when the Goods would in the ordinary course of events have been received.
- 6.3 Any liability of the Company for non-delivery of the Goods shall be limited to replacing the Goods within a reasonable time or issuing a credit note at the pro rata Contract rate against any invoice raised for such Goods.
- 7. INSTALLATION**
- 7.1 The Buyer shall be solely responsible for ensuring that its site and adequate and safe access thereto is ready for installation of the Goods. Fixing points must be adequate for the proper and secure installation of the Goods. The Buyer must pay for the cost of any modification to its site or the Goods that is required to enable the Goods to be properly installed.
- 7.2 The Buyer shall be solely responsible for all ancillary work required and costs incurred in connection with installation of Goods, including (without limitation) access, scaffolding hire, electrical work, decorating, or making good.
- 7.3 The Buyer shall advise the Company of any hidden obstruction (including without limitation, electricity, telephone and other communications cables and water, gas and drainage pipes) that may be encountered during installation of the Goods. The Company will not be liable for any damage to any structure, surface or service. The Buyer will pay all costs incurred by the Company in consequence of any damage to any hidden obstruction and will indemnify the Company against all liability, loss, cost and expense that it incurs arising out of or in consequence of installation of the Goods or damage to any structure, surface or service.
- 7.4 At all times, suppliers must comply with the Regulations. The Regulations provide that the Suppliers performing the installation services must fit any safety device supplied with the Goods.
- (a) In the event that the Customer should refuse to allow the Supplier to fit any such safety device accompanying the Goods, then the Supplier will be at liberty to refuse to carry out the Services. In such instance, the Customer will still be liable to pay the Supplier the Price in full under the Contract.
- (b) The Customer shall not be entitled to treat the Suppliers refusal to carry out any Services in relation to the Goods for the reasons set out in this clause 7.4 as a fundamental or any breach of contract. The Customer will still be bound under the Contract to take delivery of the Goods.
- 7.5 The parties to the contract consider the provisions of this clause 7.4 to be reasonable under all the circumstances given the Supplier's obligations under the Regulations.
- 8. RISK/TITLE**
- 8.1 The Goods are at the risk of the Buyer from the time of delivery.
- 8.2 Ownership of the Goods shall not pass to the Buyer until the Company has received in full (in cash or cleared funds) all sums due to it in respect of:
- (a) the Goods; and
- (b) all other sums which are or which become due to the Company from the Buyer on any account.
- 8.3 Until ownership of the Goods has passed to the Buyer, the Buyer shall:
- (a) hold the Goods on a fiduciary basis as the Company's bailee;
- (b) store the Goods (at no cost to the Company) separately from all other goods of the Buyer or any third party in such a way that they remain readily identifiable as the Company's property;
- (c) not destroy, deface or obscure any identifying mark or packaging on or relating to the Goods; and
- (d) maintain the Goods in satisfactory condition and keep them insured on the Company's behalf for their full price against all risks to the reasonable satisfaction of the Company. On request the Buyer shall produce the policy of insurance to the Company.
- 8.4 The Buyer may resell the Goods before ownership has passed to it solely on the following conditions:
- (a) any sale shall be effected in the ordinary course of the Buyer's business at full market value; and
- (b) any such sale shall be a sale of the Company's property on the Buyer's own behalf and the Buyer shall deal as principal when making such a sale.
- 8.5 The Buyer's right to possession of the Goods shall terminate immediately if:
- (a) the Buyer has a bankruptcy order made against him or makes an arrangement or composition with his creditors, or otherwise takes the benefit of any statutory provision for the time being in force for the relief of insolvent debtors, or (being a body corporate) convenes a meeting of creditors (whether formal or informal), or enters into liquidation (whether voluntary or compulsory) except a solvent voluntary liquidation for the purpose only of reconstruction or amalgamation, or has a receiver and/or manager, administrator or administrative receiver appointed of its undertaking or any part thereof, or documents are filed with the court for the appointment of an administrator of the Buyer or notice of intention to appoint an administrator is given by the Buyer or its directors or by a qualifying floating charge holder (as defined in paragraph 14 of Schedule B1 to the Insolvency Act 1986), or a resolution is passed or a petition presented to any court for the winding-up of the Buyer or for the granting of an administration order in respect of the Buyer, or any proceedings are commenced relating to the insolvency or possible insolvency of the Buyer; or
- (b) the Buyer suffers or allows any execution, whether legal or equitable, to be levied on his/its property or obtained against him/it, or fails to observe or perform any of his/its obligations under the Contract or any other contract between the Company and the Buyer, or is unable to pay its debts within the meaning of section 123 of the Insolvency Act 1986 or the Buyer ceases to trade; or
- (c) the Buyer encumbers or in any way charges any of the Goods.
- 8.6 The Company shall be entitled to recover payment for the Goods notwithstanding that ownership of any of the Goods has not passed from the Company.
- 8.7 The Buyer grants the Company, its agents and employees an irrevocable licence at any time to enter any premises where the Goods are or may be stored in order to inspect them, or, where the Buyer's right to possession has terminated, to recover them.
- 8.8 Where the Company is unable to determine whether any Goods are the goods in respect of which the Buyer's right to possession has terminated, the Buyer shall be deemed to have sold all goods of the kind sold by the Company to the Buyer in the order in which they were invoiced to the Buyer.
- 8.9 On termination of the Contract, howsoever caused, the Company's (but not the Buyer's) rights contained in this condition 8 shall remain in effect.
- 9. PRICE**
- 9.1 Unless otherwise agreed by the Company in writing, the price for the Goods and/or Services shall be the price set out in the Company's price list published on the date of delivery or deemed delivery.
- 9.2 The price for the Goods and/or Services shall be exclusive of any value added tax.
- 9.3 All costs or charges in relation to carriage and insurance during transit shall be payable by the Buyer in addition to the price of the Goods when it is due to pay for the Goods where the price of the Goods in any Contract is less than £150 before value-added tax, and in all other cases such costs or charges shall be borne by the Company.
- 10. PAYMENT**
- 10.1 Subject to condition 10.4, payment of the price for the Goods is due in pounds sterling on the last working day of the month following the month in

which the Goods are delivered or deemed to be delivered and/or the services are performed.

10.2 Time for payment shall be of the essence.

10.3 No payment shall be deemed to have been received until the Company has received cleared funds.

10.4 All payments payable to the Company under the Contract shall become due immediately on its termination despite any other provision.

10.5 The Buyer shall make all payments due under the Contract in full without any deduction whether by way of set-off, counterclaim, discount, abatement or otherwise unless the Buyer has a valid court order requiring an amount equal to such deduction to be paid by the Company to the Buyer.

10.6 If the Buyer fails to pay the Company any sum due pursuant to the Contract, the Buyer shall be liable to pay interest to the Company on such sum from the due date for payment at the annual rate of 1.5% per month, accruing on a daily basis until payment is made, whether before or after any judgment.

11. QUALITY

11.1 The Company warrants that (subject to the other provisions of these conditions):

(a) upon delivery, and for a period of five years from the date of delivery the Goods shall

- (i) be of satisfactory quality within the meaning of the Sale of Goods Act 1979;
- (ii) be reasonably fit for purpose; and
- (b) the Services shall be performed with reasonable skill and care.
- (c) This warranty applies to hardware only. Fabric is subject to suppliers' guarantees.

11.2 The Company shall not be liable for a breach of any of the warranties in condition 11.1 unless:

- (a) the Buyer gives written notice of the defect to the Company, and, if the defect is as a result of damage in transit to the carrier, within 7 days of the time when the Buyer discovers or ought to have discovered the defect;
- (b) where the contract is for supply only of Goods the Company is given a reasonable opportunity after receiving the notice of examining the Goods and the Buyer (if asked to do so by the Company) returns such Goods to the Company's place of business at the Company's cost for the examination to take place there; and
- (c) where the Contract is for supply and installation of Goods the Company is given a reasonable opportunity after receiving notice of examining the Goods and their installation on site.

11.3 The Company shall not be liable for a breach of any of the warranties in condition 11.1 if:

- (a) the Buyer makes any further use of such Goods after giving such notice; or
- (b) the defect arises because the Buyer failed to follow the Company's oral or written instructions as to the storage, installation, commissioning, use or maintenance of the Goods or (if there are none) good trade practice; or
- (c) the Buyer alters or repairs such Goods without the written consent of the Company.

11.4 Subject to condition 11.2 and condition 11.3, if any of the Goods and/or Services do not conform with any of the warranties in condition 11.1 the Company shall

- (a) if the Contract is for supply only of Goods, at its option repair or replace such Goods (or the defective part) or refund the price of such Goods at the pro rata Contract rate provided that, if the Company so requests, the Buyer shall, at the Company's expense, return the Goods or the part of such Goods which is defective to the Company;

- (b) if the Contract includes installation of Goods by the Company, the Services shall be reperfomed by the Company on site until such Services are in conformity or at the Company's option it may pay for the Services to be performed again.

11.5 If the Company complies with condition 11.4 it shall have no further liability for a breach of any of the warranties in condition 11.1 in respect of such Goods and/or Services.

11.6 Any Goods replaced shall belong to the Company and any repaired or replacement Goods shall be guaranteed on these terms for the unexpired portion of the five year period.

11.7 The Buyer is responsible for ensuring the suitability of and absence from manufacturing flaws in any fabric supplied by the Buyer and for marking any such flaws. The Company is not responsible for the performance of any fabric supplied by the Buyer, including (without limitation) its adhesive capabilities when attaching bond cloth, shrinkage, matching of patterns and manufacture into roller blinds. The Buyer is responsible for all fabric and labour costs of remedying fabric flaws discovered by the Company in the course of manufacturing the Goods.

12. LIMITATION OF LIABILITY

12.1 Subject to condition 4, condition 6 and condition 11, the following provisions set out the entire financial liability of the Company (including any liability for the acts or omissions of its employees, agents and sub-contractors) to the Buyer in respect of:

- (a) any breach of these conditions;
- (b) any use made or resale by the Buyer of any of the Goods, or of any product incorporating any of the Goods; and
- (c) any representation, statement or tortious act or omission including negligence arising under or in connection with the Contract.

12.2 All warranties, conditions and other terms implied by statute or common law (save for the conditions implied by section 12 of the Sale of Goods Act 1979) are, to the fullest extent permitted by law, excluded from the Contract.

12.3 Nothing in these conditions excludes or limits the liability of the Company:

- (a) for death or personal injury caused by the Company's negligence; or
- (b) under section 2(3), Consumer Protection Act 1987; or
- (c) for any matter which it would be illegal for the Company to exclude or attempt to exclude its liability; or
- (d) for fraud or fraudulent misrepresentation.

12.4 Subject to condition 12.2 and condition 12.3:

- (a) the Company's total liability in contract, tort (including negligence or breach of statutory duty), misrepresentation, restitution or otherwise, arising in connection with the performance or contemplated performance of the Contract shall be limited to the Contract price; and
- (b) the Company shall not be liable to the Buyer for any pure economic loss, loss of profit, loss of business, depletion of goodwill or otherwise, in each case whether direct, indirect or consequential, or any claims for consequential compensation whatsoever (howsoever caused) which arise out of or in connection with the Contract.

13. ASSIGNMENT

13.1 The Company may assign the Contract or any part of it to any person, firm or company.

13.2 The Buyer shall not be entitled to assign the Contract or any part of it without the prior written consent of the Company.

14. FORCE MAJEURE

The Company reserves the right to defer the date of delivery or to cancel the Contract or reduce the volume of the Goods ordered by the Buyer (without liability to the Buyer) if it is prevented from or delayed in the carrying on of its

business due to circumstances beyond the reasonable control of the Company including, without limitation, acts of God, governmental actions, war or national emergency, acts of terrorism, protests, riot, civil commotion, fire, explosion, flood, epidemic, lock-outs, strikes or other labour disputes (whether or not relating to either party's workforce), or restraints or delays affecting carriers or inability or delay in obtaining supplies of adequate or suitable materials, provided that, if the event in question continues for a continuous period in excess of 60 days, the Buyer shall be entitled to give notice in writing to the Company to terminate the Contract.

15. GENERAL

- 15.1 Each right or remedy of the Company under the Contract is without prejudice to any other right or remedy of the Company whether under the Contract or not.
- 15.2 If any provision of the Contract is found by any court, tribunal or administrative body of competent jurisdiction to be wholly or partly illegal, invalid, void, voidable, unenforceable or unreasonable it shall to the extent of such illegality, invalidity, voidness, voidability, unenforceability or unreasonableness be deemed severable and the remaining provisions of the Contract and the remainder of such provision shall continue in full force and effect.
- 15.3 Failure or delay by the Company in enforcing or partially enforcing any provision of the Contract shall not be construed as a waiver of any of its rights under the Contract.
- 15.4 Any waiver by the Company of any breach of, or any default under, any provision of the Contract by the Buyer shall not be deemed a waiver of any subsequent breach or default and shall in no way affect the other terms of the Contract.
- 15.5 The parties to the Contract do not intend that any term of the Contract shall be enforceable by virtue of the Contracts (Rights of Third Parties) Act 1999 by any person that is not a party to it.
- 15.6 The formation, existence, construction, performance, validity and all aspects of the Contract shall be governed by English law and the parties submit to the exclusive jurisdiction of the English courts.

16. COMMUNICATIONS

- 16.1 All communications between the parties about the Contract shall be in writing and delivered by hand or sent by pre-paid first class post or sent by fax:
- (a) (in case of communications to the Company) to its registered office or such changed address as shall be notified to the Buyer by the Company; or
 - (b) (in the case of the communications to the Buyer) to the registered office of the addressee (if it is a company) or (in any other case) to any address of the Buyer set out in any document which forms part of the Contract or such other address as shall be notified to the Company by the Buyer.
- 16.2 Communications shall be deemed to have been received:
- (a) if sent by pre-paid first class post, two days (excluding Saturdays, Sundays and bank and public holidays) after posting (exclusive of the day of posting); or
 - (b) if delivered by hand, on the day of delivery; or
 - (c) if sent by fax on a working day prior to 4.00 pm, at the time of transmission and otherwise on the next working day.
- 16.3 Communications addressed to the Company shall be marked for the attention of the Sales Director.



www.silentgliss.co.uk

Silent Gliss Ltd
Head Office and Factory
Pyramid Business Park
Poorhole Lane, Broadstairs
Kent CT10 2PT

Tel: 00 44 (0)1843 863571
Fax: 00 44 (0)1843 864503
sales@silentgliss.co.uk