

# Price List exc. VAT



January 2017





This price list is intended to give comprehensive price information on all systems and on all components used with them. Its format follows that of the main Silent Gliss catalogue. Accessories usable with any given system should appear underneath that system.

## Index



### Hand Operated Curtain Tracks, Picture Hanging

Systems 1011, 1012, 1021/1025, 1080, 1090, 1200, 1280, 3600, 3840, 6243, 6021, 6290

Pages: 2-6



### Cord Operated Curtain Tracks, Heavy Duty/Stage Curtain Tracks

Systems 3000, 3840, 3900, 6200, 6370

Pages: 7-9



### Pole Systems

Systems 1003M, 6100M, 6120M, 6130M, 6140M, 6150M, 6160M

Pages: 10-18



### Room Divider Systems, Cubicle, Shower, Safety Device System

Systems 1085, 6100, 6103, 6650

Pages: 19-20



### Electrically Operated Curtain Tracks

Systems 5100B, 5100R, 5100T, 5100TC, 5300, 5600, 5800

Pages: 21-23



### Switches, Remote Control and Multiple Operation of Motorised Systems

Systems 0450, 9940

Page: 24



### Roman, Austrian, Festoon Blind Systems

Systems 2020, 2120, 2320, 2330, 2345, 2350, Made-to-measure Roman Blinds

Pages: 25-27



### Sliding Panel Systems

Systems 2640, 2650, 2700, 2730

Page: 28-29



### Skylight Systems

Systems 2190, 2195, 8600, 8800

Page: 30-32



### Vertical Blinds

Systems 2810, 2900, 2950

Pages: 33-39



### Roller Blinds

Systems 4900, 4907, 4910, 4830, 4840, 4955, 4960, 4870, 4880, Application chart

Pages: 40-52



### Dim-Out Blinds

Systems 4710, 4730, 4740, 4760, 4770, 4780, 4590, 4595

Pages: 53-57



### Venetian Blinds

Systems 8110 (15mm), 8110PC (25mm), 8250, 8300, 8910, 8960

Pages: 58-68



### Plissé Pleated Blinds

System 8500

Pages: 69



### Digital Printing/Special Colours (profile/components)

Page: 70



### Wave® Standard Curtains

Page: 71



### Wave XL Curtains

Page: 72



### Snake Wave Curtains

Page: 73

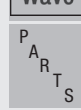

### Parts Index/Tools & Packaging/Application Chart for switches, remote control and multiple operation of motorised systems/Conditions of Sale

Pages: 74-94

## Prices

Prices are maximum recommended, not including VAT. Trade discounts applicable vary with product group as detailed below. Each system and item is designated as belonging to one of the following groups:-  
**Product Group A** 1003, 1011, 1012, 1021, 1025, 1080, 1085, 1090, 1200, 1280, 2020, 2120, 2320, 2330, 3000, 3600, 3840, 3900, 5100B, 5100R, 5100T, 5100TC, 6021, 6100, 6103, 6120, 6130, 6140, 6150\*, 6290, 6243, 6465, 6650, made to measure Roman blinds.

**Product Group C** 0450, 2190, 2195, 2345, 2350, 2640, 2650, 2700, 2730, 2810, 2900, 2950, 4590, 4595, 4710, 4730, 4740, 4760, 4770, 4780, 4830, 4840, 4870, 4880, 4900, 4907, 4910, 4955, 4960, 5300, 5600, 5800, 6150\*, 6200, 6370, 8110, 8250, 8300, 8500, 8600, 8800, 8910, 8960, 9940.

Silent Gliss Fabrics, Laminated blinds.

**Product Group E** Tools, Promotional material.

\*5100 version + 5600 version.



# Hand Operated Curtain Tracks

## System 1011

Discreet system for recessing.  
Supplied in satin silver finish as standard.  
For colours see below – special order.  
Track profile available in 6 metre lengths only. Supplied with endstop 3016 and one spring stop 3032 per length.

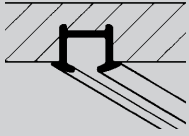

## System 1012

Supplied in satin silver finish. For special colours – see below – special order.  
Profile available in 6 metre lengths only.  
For fixing to concrete special support 3112 is used.

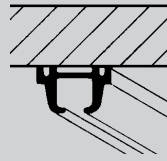

System Prices		Price Ctg.
Specific lengths charged at the nearest 25cm increment above.		<b>A</b>
cm	Silver	
125	18.03	
150	21.62	
175	25.26	
200	28.85	
225	32.46	
250	36.10	
275	39.69	
300	43.30	
325	46.90	
350	50.55	
375	54.12	
400	57.71	
425	61.35	
450	64.93	
475	68.53	
500	72.19	
525	75.75	
550	79.38	
575	83.02	
600	86.59	
Above prices are for systems ready-assembled. Substantial savings can be made for self-assembly. Rail can be supplied in full lengths or cut-to-size with accessories separately.		

Rail and Standard Accessories		Price Ctg.
1011 Rail, silver, available in 6m or cut-to-size.		<b>A</b>
3533 Glider at 16 per metre. Box, 100. Self-service sachets, 25 x 25. Outer, 25,000.		
3534 Glider, in strip form, at 16 per metre. Outer, 1,000 gliders.		
3019 Screw, 12mm/1/2" at 300mm centres, 100.		
3016 Endstop, each, 100.		
3032 Spring stop, 10, 100.		
7002 Rail protector, each, 10.		

Optional Accessories		Price Ctg.
3511 Glider, at 16 per metre, 100. Outer, 25,000 gliders.		<b>A</b>
3532 Glider. 100. Outer, 5,000.		
3570 Rotating glider, 100.		
3582 Hook. Box, 100. Self-service sachets, 25 x 25. Outer, 1,000. Outer, 20,000.		
3020 Hook. Metal, 100.		
3599 Hook. Box, 100 Self-service sachets, 25 x 25. Outer, 25,000.		
3571 Hook. Box, 100. Self-service sachets, 25 x 25. Outer, 35,000.		
3070 Twist eye endstop, each, 10.		
3025 Screw 18mm/3/4", 100.		
3562 Standard tape, 100 metres.		
3063 Connecting bridge, each.		
3071 Screw twist end stop, each.		
3548 Retrofit glider, 25,100, 1000.		
3068A Loop tape, 250 metres.		
-----		
10430 - 10434 Draw rods, white or aluminum		<b>C</b>
Colours Special order – see Page 70.		<b>E</b>

Tools		Price Ctg.
80018 Slotting tool.		<b>E</b>
7550 Centre fixing tool.		
7809 Filler set at 200cm.		
-----		
Bending		Price Ctg.
	Max. trade discount	33 1/3%
Angle bend, each £21.00		

System Prices		Price Ctg.
Specific lengths charged at the nearest 25cm increment above.		<b>A</b>
cm	To Wood 1012 S	
125	17.52	
150	20.99	
175	24.52	
200	28.05	
225	31.52	
250	35.06	
275	38.56	
300	42.05	
325	45.55	
350	49.06	
375	52.57	
400	56.05	
425	59.55	
450	63.07	
475	66.59	
500	70.07	
525	73.55	
550	77.11	
575	80.60	
600	84.12	

To Concrete		Price Ctg.
cm	1012 S	
125	19.06	
150	22.89	
175	26.72	
200	30.51	
225	34.39	
250	38.18	
275	42.01	
300	45.77	
325	49.59	
350	53.39	
375	57.23	
400	61.07	
425	64.88	
450	68.70	
475	72.54	
500	76.29	
525	80.14	
550	83.95	
575	87.80	
600	91.58	

Rail and Standard Accessories		Price Ctg.
1012 Rail, silver, available in 6m or cut-to-size.		<b>A</b>
3533 Glider at 16 per metre. Box, 100. Self-service sachets, 25 x 25. Outer, 25,000.		
3534 Glider, in strip form, at 16 per metre. Outer, 1,000 gliders.		
3019 Screw, 12mm/1/2" at 300mm centres, 100.		
3016 Endstop, each, 100.		
3021 Screw raised head No. 6 for concrete fixing support.		
3112 Support for concrete fixing metal, 100.		
7002 Rail protector, each, 10.		
-----		
10430 - 10434 Draw rods, white or aluminum		<b>C</b>
Colours Other colours special order – see Page 70.		<b>E</b>
-----		
Tools		Price Ctg.
80018 Slotting tool.		<b>E</b>
7103 Portable hand operated bending tool.		
7109 Portable electrically operated bending tool.		
7550 Centre fixing tool.		
7809 Filler set at 200cm		
-----		
Bending		Price Ctg.
	Max. trade discount	33 1/3%
Angle bend, each £21.50		
Semi-circle or gradual curve, £28.50		
Arch, £54.50		

All prices shown exclude VAT



# Hand Operated Curtain Tracks

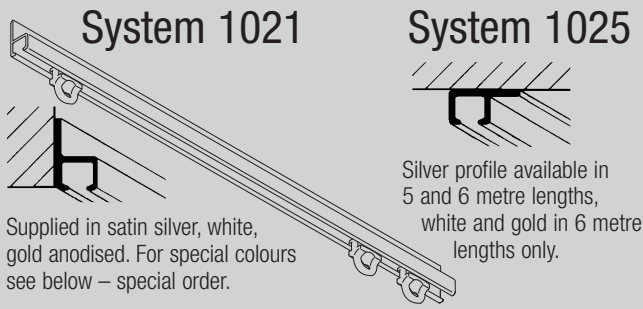

Supplied in satin silver, white, gold anodised. For special colours see below – special order.

## System 1025

Silver profile available in 5 and 6 metre lengths, white and gold in 6 metre lengths only.



## System 1080

Supplied in satin silver anodised finish, white, antique bronze, gold, black, brushed aluminium and cream. For other colours – see below. Silver and white profile available in 5 and 6 metre lengths, coloured profiles in 6 metre lengths.

System Prices			Price Ctg.
Specific lengths charged at the nearest 25cm increment above.			A
cm	Silver	Gold, White	
125	13.87	22.61	
150	16.68	27.15	
175	19.44	31.65	
200	22.20	36.13	
225	24.99	40.67	
250	27.77	45.14	
275	30.52	49.68	
300	33.33	54.23	
325	36.11	58.74	
350	38.87	63.25	
375	41.61	67.78	
400	44.44	72.29	
425	47.23	76.79	
450	49.97	81.28	
475	52.76	85.90	
500	55.52	90.37	
525	58.31	94.88	
550	61.12	99.40	
575	63.85	103.94	
600	66.64	108.43	

Above prices are for systems ready-assembled. Substantial savings can be made for self-assembly. Rail can be supplied in full lengths or cut-to-size with accessories separately.

Rail and Standard Accessories			Price Ctg.
1021/1025 Rail, silver available in 5m and 6m or cut-to-size. White and gold available in 6m or cut-to-size.			A
3533 Glider at 16 per metre. Box, 100. Self-service sachets, 25 x 25. Outer, 25,000.			
3534 Glider, in strip form, at 16 per metre. Outer, 1,000 gliders.			
6835A Screw, 12mm/1/2" No. 4 round head at 300mm centres, 100.			
3016 Endstop, each, 100.			

All prices shown exclude VAT

Optional Accessories			Price Ctg.
3511 Glider, at 16 per metre, 100. Outer, 25,000 gliders.			A
3532 Glider. 100. Outer, 5,000.			
3570 Rotating glider, 100.			
3582 Hook, Box, 100. Self-service sachets, 25 x 25. Outer, 1,000. Outer, 20,000.			
3020 Hook. Metal, 100.			
3599 Hook. Box, 100. Self-service sachets, 25 x 25. Outer, 25,000.			
3032 Spring stop, 10, 100.			
3070 Twist eye endstop, each, 10.			
3071 Screw twist endstop, each, 10.			
3562 Standard tape, 100 metres.			
3580 Side mounted glider/hook, 100. Outer, 5,000.			
3571 Hook. Box, 100. Self-service sachets, 25 x 25. Outer, 35,000.			
6835B Screw 24mm/1", 100.			
3548 Retrofit glider, 25, 100, 1000.			
3068A Loop tape, 250 metres.			

10430 - 10434 Draw rods, white or aluminum	C
--	---

Colours Other colours special order – see Page 70.	E
---	---

Tools 80018 Slotting tool 7809 Filler set at 200cm	E
--	---

Bending Angle bend, each £30.00	Max. trade discount 33 1/3%
------------------------------------	--------------------------------

Optional Accessories			Price Ctg.
3016 Endstop, each, 100.			A
3511 Glider, at 16 per metre, 100. Outer, 25,000 gliders.			
3570 Rotating glider, 100.			
3020 Hook. Metal, 100.			
3638 Reinforced corner piece for pelmets, each, 10.			
3603 Top fix brackets, white, each, 10, 100.			
3548 Retrofit glider, 25, 100, 1000.			

System Prices				Price Ctg.
Specific lengths charged at the nearest 25cm increment above.				A
cm	1080 W/S	1080 Ab/Gd/Ba/B/Cr		
125*	20.53	31.58		
150*	24.62	37.87		
175*	28.72	44.22		
200*	32.82	50.55		
225*	36.91	56.86		
250*	41.01	63.21		
275*	45.12	69.45		
300	49.25	75.76		
325	53.31	82.13		
350	57.48	88.42		
375	61.52	94.76		
400	65.60	101.05		
425	69.73	107.35		
450	73.84	113.70		
475	77.91	120.02		
500	82.05	126.29		
525	86.11	132.63		
550	90.23	138.97		
575	94.33	145.24		
600	98.41	151.61		

Above prices are for systems ready-assembled. Substantial savings can be made for self-assembly. Rail can be supplied in full lengths or cut-to-size with accessories separately.

\*1080W Packed in Acetate:  
For sizes marked with an asterisk above we offer our 1080 in white only in clear acetate self-service display packaging. Prices are the same as indicated above. Min. order 12 lengths – mixed sizes/combined with 3000 system – and multiples of 12 thereafter.

Rail and Standard Accessories			Price Ctg.
1080 Rail, silver, white, in 5m & 6m, antique bronze, gold, black, cream in 6m, brushed aluminium in 4m.			A
3533 Glider Box, 100. Self-service sachets, 25 x 25. Outer, 25,000. Euroslot sachet 25.			
3534 Glider, in strip form, at 16/m.			
18R Screw 25mm/1". No. 8 round head, 100.			
3667 Endcover/stop, grey or white, each 10, 100. Euroslot sachet 2.			
3630 Universal nylon bracket, white at 600mm centres, each 10, 100. Euroslot sachet 2.			

Optional Accessories			Price Ctg.
3016 Endstop, each, 100.			A
3511 Glider, at 16 per metre, 100. Outer, 25,000 gliders.			
3570 Rotating glider, 100.			
3020 Hook. Metal, 100.			
3638 Reinforced corner piece for pelmets, each, 10.			
3603 Top fix brackets, white, each, 10, 100.			
3548 Retrofit glider, 25, 100, 1000.			

System Prices			Price Ctg.
3630 Universal bracket, brown gold, each, 10.			A
3133 Extension bracket cover, white, 10, 100.			
3133L Long extension bracket cover, white, 10, 100.			
3571/3582/3599 Hooks - see under 1021/5.			
3070 Twist eye endstop, each, 10.			
1128R Screw 37mm/1 1/2", No. 8 round head, 100.			
3533/6146 Glider hook, 20.			
6146 Nylon hook, 12.			
3660 Extra long universal bracket.			
3655 Long universal bracket.			
3562 Standard tape, 100 metres.			
3615 Clamp.			
3620 Connecting bridge, each, 10.			
3602 Nylon wall support, grey, white, each, 10.			
3606 Snap fastener each, 10.			
3618 Metal wall support, each, 10.			
3626 Return fixing bracket, each.			
3639 Hanger rod assembly, 2' system complete.			
3648 Eyelet for 3638.			

Fixed Extension Brackets in Silver, White or Brown  
3134 2"/50mm 1 drilled & tapped hole. Each with 2 pre-drilled & tapped holes.  
3135 3"/75mm 3136 4"/100mm 3137 5"/125mm  
Each with 3 pre-drilled & tapped holes.  
3138 6"/150mm 3139 7"/200mm

Adjustable extension brackets in Silver, White or Brown  
3275 7.7cm - 10.7cm  
3276 10cm - 13cm  
3277 13cm - 16cm

0516 Clearance spacer (for top boards).	E
---	---

Colours Other colours special order – see page 70.	E
---	---

Tools, etc			Price Ctg.
80018 Slotting tool.			E
7103 Portable hand operated bending tool.			
7109 Portable electrically operated bending tool.			
7806 Filler set for 1080 at 200cm for 7103/9.			
0540 Bending tool for gradual curves.			

Bending			Price Ctg.
Angle bend each £27.00 Semi-circle or gradual curve £35.00 Arch £65.50			Max. trade discount 33 1/3%
Note: Angle bends are only available from Wholesalers, Retail Support Specialists (RSS) and Distributors.			

3600 Picture Hanging System			Price Ctg.
Use prices for 1080 rail only and 3606 supports, covers 3605 where necessary plus special components below.			A
3637 Cord ø 1.5mm nom.			
3600 Picture hanging system complete (including 4x3663, cord 3637 & 3634 delrin height adjuster)			
3657 Connecting bridge for picture hanging system.			
3605 Endcover.			

See price index for individual prices



# Hand Operated Curtain Tracks

## System 1090

Supplied in satin silver anodised finish, and white. For other colours see below. Silver and white profiles available in 5 and 6 metre lengths, bronze profile in 6 metre lengths only.

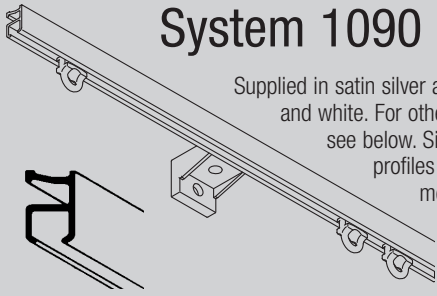

## System 1200

White profile 1200 available in full lengths only (5m/6m) with accessories in contract outers as indicated below.

**metallic line**

Available in 6m lengths (black, gunmetal, silver anodised) or 4m lengths (brushed aluminium/chrome effect/anthracite).

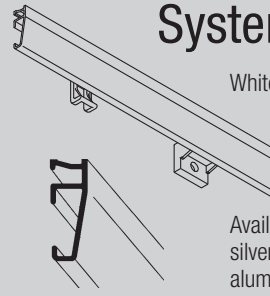

	Price Ctg.
<b>System Prices</b>	<b>A</b>
1090	
cm W/S	
125 18.97	
150 22.79	
175 26.57	
200 30.38	
225 34.17	
250 37.93	
275 41.72	
300 45.53	
325 49.37	
350 53.18	
375 56.92	
400 60.73	
425 64.49	
450 68.32	
475 72.08	
500 75.93	
525 79.70	
550 83.48	
575 87.3	
600 91.06	
Tracks between those specified will be charged at the nearest standard length above.	

Above prices are for systems ready-assembled. Substantial savings can be made for self-assembly. Rail can be supplied in full lengths or cut-to-size with accessories separately.

### Rail and Standard Accessories

1090 Rail, silver and white in 5m, 6m or cut-to-size.  
3533 Glider. Box, 100.  
Self-service sachets, 25 x 25.  
Outer, 25,000. Euroslot sachet 25.  
3534 Glider, in strip form, at 16 per metre.  
Outer, 1,000 gliders.  
18R Screw, 25mm/1", No. 8 round head, 100.  
3016 Endstop, each, 100.  
3175 Universal Nylon Bracket, white, 10, 100.

	Price Ctg.
<b>Optional Accessories</b>	<b>A</b>
3511 Glider, at 16 per metre, 100. Outer, 25,000 gliders.	
3570 Rotating glider, 100.	
3582 Hook, 100. Self-service sachets, 25 x 25.	
Outer, 1,000. Outer, 20,000.	
3020 Hook. Metal, 100.	
3599 Hook. Box, 100. Self-service sachets, 25 x 25. Outer, 25,000.	
3176 Top fix bracket, white, 10, 100.	
3070 Twist eye endstop, each, 10.	
1128R Screw 37mm/1 1/2", No. 8 round head, 100.	
3133 Extension bracket cover, white, 10, 100.	
3548 Retrofit glider, 25, 100, 1000.	
<b>Fixed Extension Brackets</b>	
Each with 1 or 2 pre-drilled and tapped holes, in silver, white or brown:	
3134 2"/50mm (1) 3135 3"/75mm (2)	
3136 4"/100mm (2) 3137 5"/125mm (2)	
Each with 3 pre-drilled and tapped holes:	
3138 6"/150mm 3139 7"/200mm	

### Adjustable extension brackets in Silver, White or Brown

3275 7.7cm-10.7cm  
3276 10cm-13cm  
3277 13cm-16cm  
3562 Standard tape, 100 metres.  
3096 Connecting bridge, each, 10.  
3113 5cm metal spacer, 10, 100.  
3115 7cm metal spacer, 10, 100.

10430 - 10434 Draw rods, white or aluminum

### Colours

Other colours special order – see page 70.

### Tools

Sleeving SL1090, SL1090W per reel.  
80018 Slotting tool.  
7100 Bending tool.  
7809 Filler set at 200cm, 2 required

### Bending

Max. trade discount 33 1/3%  
Angle bend £21.50 each.  
Semi-circle or gradual curve £28.50 each.

	Price Ctg.
<b>System Prices</b>	<b>A</b>
1200	
cm W/S Bl/Gm/ Ac/Ba 1200 Ch	
125 19.06 28.20 40.33	
150 22.89 33.84 48.55	
175 26.72 39.46 57.05	
200 30.51 45.08 65.44	
225 34.36 50.74 74.03	
250 38.18 56.34 82.54	
275 42.01 62.01 90.81	
300 45.78 67.59 99.53	
325 49.59 73.29 107.85	
350 53.39 78.88 116.35	
375 57.24 84.55 124.97	
400 61.07 90.13 133.37	
425 64.88 95.81 142.02	
450 68.70 101.45 150.24	
475 72.48 107.11 158.85	
500 76.30 112.71 167.64	
525 80.16 118.34 175.80	
550 83.95 123.96 184.37	
575 87.82 129.61 192.60	
600 91.58 135.25 201.45	
*Note: Chrome effect & Anthracite/Brushed Aluminium available up to 4m lengths only.	

### Rail and Standard Accessories

1200 Rail, white, available in 5m or 6m lengths, in outers of 10 lengths only.

1200 **metallic line**  
Available in 6m lengths, (Black/gunmetal, silver anodised) or 4m lengths (anthracite, brushed aluminium/chrome effect).

3933 'Click' glider in strip form, 14 per metre, outer of 1,000 gliders.

3986 Endcover, white, grey, dark grey or black, 10, 100.

3175 Universal nylon bracket, white, each, 10, 100.

	Price Ctg.
<b>Optional Accessories</b>	<b>A</b>
3947 Pair of magnetic gliders, 10.	
3942 Intermediate stop, 10.	
18R Screw 25mm/1", No. 8 round head, 100.	
3176 Top fix bracket, white, 100.	
3582 Hook, box 100, outer 1,000, outer 20,000.	
3599 Hook, box 100, outer 25,000.	
3562 Standard tape, 100m.	
3133 Extension bracket cover, white, black, gunmetal, silver, chrome, 10, 100.	
3133L Long extension bracket cover, white, 10, 100.	
<b>Fixed extension brackets</b>	
(For colours see index pages)	
3134 2"/50mm 1 drilled and tapped hole. Each with 2 pre-drilled and tapped holes:	
3135 3"/75mm 3136 4"/100mm	
3137 5"/125mm	
Each with 3 pre-drilled and tapped holes:	
3138 6"/150mm 3139 7"/200mm	
<b>Adjustable extension brackets in white</b>	
3275 7.7cm - 10.7cm.	
3276 10cm - 13cm.	
3277 13cm - 16cm.	
0516 Clearance spacer (for top boards), 100.	<b>E</b>
<b>Colours</b>	<b>E</b>
To special order – see Page 70.	
<b>Tools</b>	<b>E</b>
7103 Portable hand operated bending tool.	
7109 Portable electrically operated bending tool.	
0650 Bending kit for 7103/7109 incl. filler set, blocks, arms and rings.	
<b>Bending</b>	<b>Max. trade discount 33 1/3%</b>
Angle bend £26.50 each Semi-circle or gradual curve £35.00	

### Note: System 1200 White

Track and components sold only in contract quantities. System not available ready assembled or cut to length from Silent Gliss. We recommend Wholesalers, Retail Support Specialists (RSS) and Distributors who are able to offer the service. Recommended retail prices above are based on standard accessories detailed.

Angle bending of this system is only carried out by Wholesalers, Retail Support Specialists (RSS) and Distributors.

All prices shown exclude VAT





# Hand Operated Curtain Tracks

## System 6243

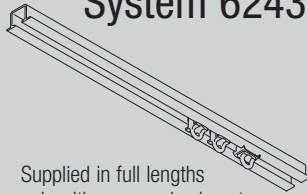

Supplied in full lengths only with accessories in outers as indicated below. White profile 6243 available in 5m lengths.

## System 6290

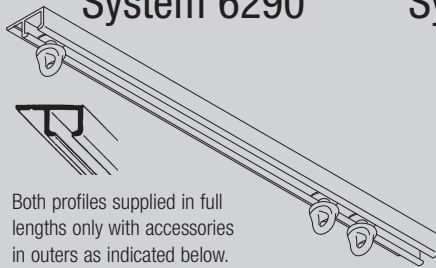

Both profiles supplied in full lengths only with accessories in outers as indicated below.

## System 6021

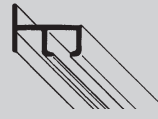

Both white profiles available in 5m or 6m lengths.

System Prices				Price Ctg.
System price including Wave supplement				A
cm	Standard Glider £	Wave Glider 60mm £	Wave Glider 80mm £	
125	33.69	53.96	50.82	
150	37.93	62.27	58.49	
175	42.18	70.56	66.16	
200	46.43	78.87	73.83	
225	50.67	87.17	81.50	
250	54.92	95.47	89.17	
275	59.15	103.78	96.84	
300	63.40	112.07	104.51	
325	67.66	120.38	112.19	
350	71.90	128.68	119.86	
375	76.15	136.98	127.53	
400	80.38	145.28	135.20	
425	84.63	153.58	142.87	
450	88.88	161.88	150.54	
475	93.12	170.19	158.21	
500	97.37	178.48	165.89	
525	101.62	186.79	173.56	
550	105.86	195.08	181.23	
575	110.11	203.39	188.90	
600	114.35	211.69	196.57	
Hand Operated Enhanced Wave® (80mm only) Add the following supplement to System prices above: Single-stack £34.43; Pair-stack £68.84				A
<b>Rail and Standard Accessories</b>				A
6053 Spring Stop, 10.				
6243 White rail available in 6m lengths only.				
6065 Twist eye end stop, 10, 100.				
0240 Screw, 19mm, 100.				
Plus one of the following options:				
<b>Standard Gliders</b>				
6096 Glider in strip form. Outer 1,000.				
<b>Wave Gliders</b>				
6345 Glider-cord 60mm. Outer of 50mm				
6346 Glider-cord 80mm. Outer of 50mm				
7002 Rail protector				
<b>Optional Accessories</b>				E
3067 Connecting bridge.				
<b>Colours</b>				E
To special order – see page 70.				
10483 Child Safety Device (only applicable for complete systems with curtains by Silent Gliss.				E
<b>Tools</b>				
7230 Slotting tool.				
<b>Bending</b>				33 1/3%
Max. trade discount				
Angle bend £27.00				
Gradual curve £35.00				

System Prices		Price Ctg.
6290 (W)		A
cm	£	
125	18.64	
150	22.38	
175	26.07	
200	29.80	
225	33.54	
250	37.22	
275	41.00	
300	44.69	
325	48.46	
350	52.16	
375	55.91	
400	59.61	
425	63.34	
450	67.07	
475	70.80	
500	74.51	
525	78.25	
550	81.97	
575	85.71	
600	89.43	
<b>System Prices</b>		
a) Recommended Retail Prices for assembled systems.		
	Per metre	
6021 White (W)	£19.28	
6021 (W)		
cm	£	
125	23.92	
150	28.71	
175	33.48	
200	38.25	
225	43.04	
250	47.81	
275	52.59	
300	57.34	
325	62.15	
350	66.97	
375	71.74	
400	76.51	
425	81.27	
450	86.07	
475	90.85	
500	95.64	
525	100.41	
550	105.18	
575	109.96	
600	114.77	
<b>Note:</b>		
Track and components sold only in quantities indicated below. System not available ready assembled or cut to length from Silent Gliss. We recommend Wholesalers, Retail Support Specialists (RSS) and Distributors who are able to offer the service. Above recommended retail prices are based on standard accessories detailed below.		

Rail and Standard Accessories		Price Ctg.
6290 White rail, available in 5/6m lengths, in outers of 10 lengths only.		A
6122 Endstop, 100.		
6148 Glider at 10 per m, 1,000.		
6149 Lead glider (blue) at 2 per length, 100.		
<b>Optional Accessories</b>		
0688 Self drilling wood screw, 100.		A
3582 Hook, 100, 1,000, 20,000.		
3599 Hook, 100, 25,000.		
3562 Standard tape, 100m.		
10430 - 10434 Draw rods, white or aluminum		C
<b>Colours</b>		E
To special order - see Page 70.		
<b>Bending</b>		
Straight only.		





# Cord Operated Curtain Tracks

## System 3000

Supplied in satin silver finish, gold, antique bronze, black, white and brushed aluminium. Profile only number is 1082. Silver and white profile available in 5 or 6 metre lengths, colour profile in 6 metre lengths. Brushed aluminium in 4 metre lengths only.

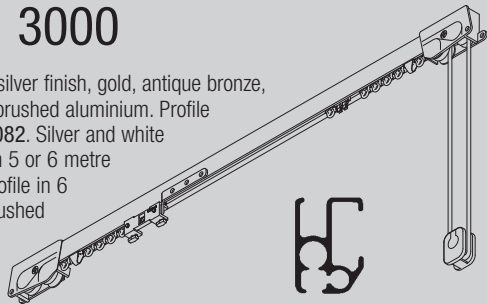

## System 3840

Supplied in satin silver, white, antique bronze, gold and black. Available in 6 metre lengths only. 3840 is supplied with gliders 6083, 3840R is supplied with roller gliders 6283. Top fixed as standard.

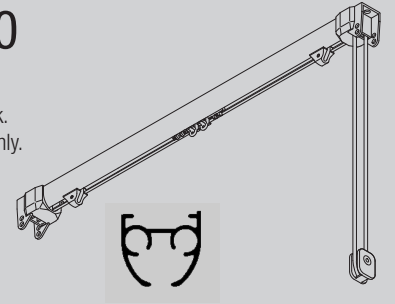

### System Prices

cm	3000 W/S	3000 AB/Gd/Bl/Ba
125	80.02	100.23
150	85.56	108.91
175	91.13	117.50
200	96.73	126.17
225	102.25	134.76
250	107.81	143.41
275	113.38	152.05
300	118.93	160.68
325	124.47	169.28
350	130.01	177.93
375	135.62	186.54
400	141.17	195.15
425	146.74	203.77
450	152.25	212.42
475	157.87	221.07
500	163.40	229.71
525	168.95	238.34
550	174.52	246.99
575	180.06	255.59
600	185.62	264.23

Note: Brushed aluminium available up to 4m lengths only.

Track lengths between those specified will be charged at the rate for the nearest standard length above. 3242 overlap arm standard. Right hand pull as standard.

Above prices are for systems ready-assembled. Substantial savings can be made for self-assembly. Rail can be supplied in full lengths or cut-to-size with accessories separately.

### Rail and Standard Accessories

1082 Rail, brushed aluminium in 4m or cut-to-size, silver and white in 5m, 6m or cut-to-size, antique bronze, gold & black in 6m or cut-to-size.  
 3533 Glider. Box, 100. Self-service sachets, 25 x 25. Outer, 25,000. Euroslot sachet 25.  
 3534 Glider, in strip form, 16 per metre. Outer, 1,000 gliders.  
 18R Screw 25mm/1", No. 8 round head, 100.  
 3630 Universal bracket, white, each, 10, 100, Euroslot sachet 2.

### System Prices

3242 Overlap, each, 10, 100. Euroslot sachet 1.  
 3288 Pair of endpieces, including Pilot runners 3030/3213, grey, white, black, antique bronze, gold. Outer, 25 sets, per set.  
 3090 Cord 100, metres, 500 metres.  
 3070 Twist eye endstop, each 10.  
 1348R Screw round head No. 8 44mm/1 3/4" for spacer 1105, 100.  
 1105 Spacer for cord pull end.

### 10400 Cord retainer

### Optional Accessories

3511 Glider, at 16 per metre, 100. Outer, 25,000 gliders.  
 3570 Rotating glider, 100.  
 3582 Hook. Box, 100 Self-service sachets, 25 x 25. Euroslot sachets 25. Outer, 1000. Outer, 20,000.  
 3020 Hook. Metal, 100.  
 3599 Hook. Box, 100. Self-service sachets, 25 x 25. Euroslot sachet 25. Outer, 25,000.  
 3571 Hook. Box 100. Self-service sachets, 25 x 25. Outer 35,000. Euroslot sachet 25.  
 3603 Top fix brackets, white at 600mm centres each, 100. Euroslot sachet 2.  
 1128R Screw 36mm/1 1/2", No. 8 round head, 100.  
 3289/3289W Set end pieces with return, including pilot runners, set.  
 3655 Long universal bracket.  
 3660 Extra long universal bracket.  
 3562 Standard tape, 100 metres.  
 3620 Connecting bridge, each.  
 3208 Intermediate pulley, white, grey, antique bronze, black, gold, each, 10.  
 3045 Metal overlap arm, each, 10.  
 3231 End fixing bracket, each, 10.  
 3615 Clamp.  
 3032 Springstop, 10, 100.  
 3133 Extension bracket cover, white, 10, 100.  
 3133L Long extension bracket cover, white, 10, 100.  
 0516 Clearance spacer (for top boards).  
 For Extension Brackets, see system 1080.

### Colours

Other colours special order – see page 70.

**Tools**  
 SL3000 Reel, sleeving.  
 SL3000W Reel, sleeving.  
 80018 Slotting tool.  
 7103 Portable hand operated bending tool.  
 7004 Cording needle.  
 7109 Portable electrically operated bending tool.  
 Instruction leaflet.  
 7805 Filler set 3000 at 200cm for 7103/9.  
 0540 Bending tool for gradual curves.

### Bending

Max. trade discount 33 1/3%

Angle bend, each £31.50  
 Semi-circle or gradual curve £46.00

Note: Angle bends are only available from Wholesalers, Retail Support Specialists (RSS) and Distributors.

### System Prices

cm	Using Standard Gliders		Using Roller Gliders	
	W/S	AB/Gd/Bl	W/S	AB/Gd/Bl
125	77.29	99.79	87.86	110.37
150	85.07	110.81	97.74	123.49
175	92.76	121.81	107.66	136.71
200	100.57	132.89	117.46	149.78
225	108.34	143.90	127.39	162.96
250	116.07	154.90	137.28	176.11
275	123.85	165.96	147.08	189.20
300	131.63	176.97	156.96	202.29
325	139.31	188.00	166.79	215.49
350	147.08	198.99	176.75	228.64
375	154.84	210.05	186.60	241.82
400	162.62	221.07	196.47	254.92
425	170.34	232.07	206.33	268.05
450	178.13	243.09	216.21	281.16
475	185.86	254.11	226.10	294.36
500	193.69	265.16	235.96	307.42
525	201.42	276.17	245.81	320.54
550	209.18	287.18	255.69	333.68
575	216.92	298.25	265.59	346.92
600	224.70	309.23	275.48	360.00

cm	Using Standard Wave Gliders			
	60mm glider cord		80mm glider cord	
	W/S	AB/Gd/Bl	W/S	AB/Gd/Bl
125	94.41	116.92	91.17	113.67
150	105.62	131.36	101.90	127.64
175	116.74	145.79	112.11	141.16
200	127.97	160.29	122.43	154.75
225	139.16	174.73	133.14	168.65
250	150.32	189.15	143.40	182.23
275	161.52	203.64	154.12	196.24
300	172.73	218.07	164.43	209.77
325	183.84	232.53	174.62	223.31
350	195.04	246.94	185.35	237.25
375	206.22	261.43	195.62	250.83
400	217.42	275.87	205.92	264.36
425	228.57	290.30	216.58	278.32
450	239.78	304.74	226.90	291.85
475	250.94	319.19	237.57	305.83
500	262.20	333.66	247.92	319.39
525	273.36	348.10	258.18	332.92
550	284.54	362.53	268.88	346.88
575	295.70	377.03	279.14	360.47
600	306.91	391.43	289.44	373.96

cm	Using Wave Roller Gliders	
	W/S	AB/Gd/Bl
125	136.11	158.61
150	155.63	181.38
175	175.20	204.24
200	194.65	226.98
225	214.22	249.80
250	233.76	272.59
275	253.22	295.34
300	272.74	318.08
325	292.23	340.92
350	311.82	363.72
375	331.33	386.54
400	350.85	409.29
425	370.35	432.08
450	389.88	454.84
475	409.43	477.68
500	428.93	500.39
525	448.43	523.16
550	467.96	545.95
575	487.50	568.84
600	507.05	591.57

Track lengths between those specified will be charged at the rate for the nearest standard length above. Overlap arm 6032 is standard.

Above prices are for systems ready-assembled. Substantial savings can be made for self-assembly. Rail can be supplied in full lengths or cut-to-size with accessories separately.

All prices shown exclude VAT



# Cord Operated Curtain Tracks

## System 3840

## System 3900

Supplied in full lengths only with accessories in outers as indicated below.  
White profile 3982 available in 5 metre or 6 metre lengths.

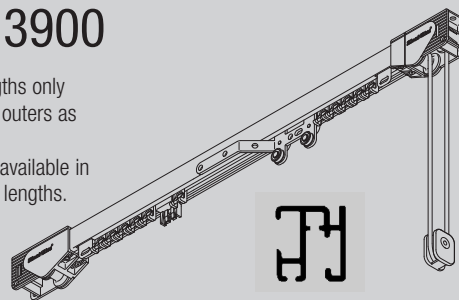

	Price Ctg.
<b>Rail and Standard Accessories</b>	<b>A</b>
3841 Rail, silver, white, antique bronze, gold and black available in 6m or cut-to-size.	
3090 Cord, 100 metres. 500 metres.	
3825 Clamp at 30cm intervals, 10, 100.	
3845 Endpiece set, white, grey, gold, black or brown.	
1148C Screw, 31mm/1 1/4", No. 8 countersunk, 100.	
Self-service sachets 25 x 25.	
6096 Glider in strip form. Outer, 1,000.	
6288 Plastic overlap arm, each, 10.	
6086 Spring stop, each 10, 100.	
Plus one of the following glider options:	
<b>Standard Gliders</b>	
6083 Glider in strip form at 16 per metre. Outer, 1,000 gliders	
6096 Glider. Box 1000.	
<b>Roller Gliders</b>	
6283 Roller glider at 10 per metre. Outer 10, 100.	
<b>Wave Gliders</b>	
6345 Glider-cord 60mm pitch. Outer of 50mm.	
6346 Glider-cord 80mm pitch. Outer of 50mm.	
6098W Roller glider-cord 80mm pitch. Outer of 50mm.	
-----	
10400 Cord retainer	<b>E</b>
10483 Child safety device (only applicable for complete systems with curtains by Silent Gliss).	

	Price Ctg.
<b>Optional Accessories</b>	<b>A</b>
(additional charges may apply).	
3020 Hook. Metal, 100.	
3133 Extension bracket cover, white, 10, 100.	
3133L Long extension bracket cover, white, 10, 100.	
3562 Standard tape, 100 metres.	
3571 Hook, Box 100. Self-service sachets, 25 x 25. Outer, 35,000.	
3582 Curtain hooks (each).	
3582 Hook. Box, 100. Self-service sachets, 25 x 25. Outer, 20,000.	
3599 Hook. Box 100. Self-service sachets, 25 x 25. Outer, 25,000.	
3802 Connecting bridge, each.	
3826W Nylon bracket, (top fix).	
3832 Clamp for top fixing.	
3833A Intermediate pulley, white, each.	
3836 Nylon bracket, (face fix).	
3846 Endpieces set with return including pair of pilot runners and 2 x 3816 endpieces, white.	
6063 Overlap arm, each, 10.	
6094 Roller glider with hook, 10, 100.	
6098 Roller glider with eye,	
6345 Glider-cord 60mm pitch	
6346 Glider-cord 80mm pitch	
6349 Wave® curtain tape (per m).	
6363 Iron-on hemming tape.	
6365 Hanger.	
6364 Extension.	
6098W Roller glider cord 80mm.	
<b>Extension Brackets with Rivetted Clamps 3825</b>	
3275/3825 3276/3825 3277/3825	
<b>Fixed Extension Brackets in silver, white or brown</b>	
Each with 1 and 2 pre-drilled and tapped holes:	
3134 2"/50mm(1) 3135 3"/75mm(2)	
3136 4"/100mm(2) 3137 5"/125mm(2)	
Each with 3 pre-drilled & tapped holes	
3138 6"/150mm 3139 7"/200mm	
<b>Colours</b>	<b>E</b>
Other colours special order – see page 70.	
<b>Tools</b>	<b>E</b>
7103 Portable hand operated bending tool.	
7109 Portable electrically operated bending tool.	
7802 Filler set 3840 at 200cm for 7103/9.	
-----	
<b>Enhanced Wave® System supplement per system £</b>	
80mm Single-stack 26.42	
80mm Pair-stack 42.78	
<b>3840 with Wave XL</b>	
Price supplement of £49.67 per metre.	
<b>Bending</b> Max. trade discount 331/3%	
Angle bend £41.00	
Semi-circle or gradual curve £55.00	

	Price Ctg.
<b>System Prices</b>	<b>A</b>
3900(W)	
cm	£
125	80.51
150	88.41
175	96.37
200	104.24
225	112.23
250	120.13
275	128.09
300	136.02
325	143.91
350	151.86
375	159.81
400	167.72
425	175.61
450	183.57
475	191.50
500	199.44
525	207.32
550	215.29
575	223.20
600	231.08
<b>Note:</b>	
Track and components sold only in quantities indicated below.	
System 3900W not available ready assembled or cut to length from Silent Gliss. We recommend Wholesalers, Retail Support Specialists (RSS) and Distributors who are able to offer this service.	
Above recommended retail prices are based on standard accessories detailed below.	
<b>Rail &amp; Standard Accessories</b>	<b>A</b>
3982W White rail, available in 5m or 6m lengths, in outers of 10 lengths only.	
3630 Universal nylon bracket, white, at 600mm centres, 100.	
3090 Cord, 100 metres, 500 metres.	
3915 Endpiece set, incl. pilot runners 3939/3917, white, outer of 20 or 50 only.	
3922 Roller glider in strip form at 10 per metre, outer of 1,000 gliders, outer of 6,000 gliders.	
3936 Overlap arm, outer of 20 only.	
-----	
10400 Cord retainer	<b>E</b>

	Price Ctg.
<b>Optional Accessories</b>	<b>A</b>
3582 Hook, box 100, outer 1,000, outer 20,000.	
3599 Hook, box 100, outer, 25,000.	
3603 Top fix bracket, white, at 600mm centres, outer of 100.	
18R Screw 25mm/1" No. 8 round head, 100.	
3620 Connecting bridge, each.	
3655 Long universal bracket.	
3660 Extra long universal bracket, each.	
3914 Bracket for return profile, each.	
3916 Pilot runner for multi stack system.	
3929 Intermediate pulley, white, each 10.	
3932 Spring stop, each 10.	
3935 Straight overlap arm, each, 10.	
3639 Hanger assembly complete, each.	
3133 Extension bracket cover, white, 10, 100.	
3133L Long extension bracket cover, white, 10, 100.	
0516 Clearance spacer (for top boards).	
<b>Fixed Extension brackets.</b>	
Each with 1 or 2 pre-drilled and tapped holes, in white.	
3134 2"/50mm(1) 3135 3"/75mm(2)	
3136 4"/100mm(2) 3137 5"/125mm(2)	
Each with 3 pre-drilled and tapped holes in white.	
3138 6"/150mm 3139 7"/200mm	
<b>Adjustable extension brackets in White.</b>	
3275 7.7cm - 10.7cm.	
3276 10cm - 13cm.	
3277 13cm - 16cm.	
<b>Tools</b>	<b>E</b>
7103 Portable hand operated bending tool.	
7109 Portable electrically operated bending tool.	
0545 Bending kit for 7103/7109 including filler set, blocks, arms and rings.	
80018 Slotting tool.	
7803 Filler set for 7103/7109, 200cm.	
0540 Bending tool for gradual curves.	
<b>Bending</b> Max. trade discount 331/3%	
Angle bend £45.50	
Semi-circle or gradual curve £65.00	
<b>Note:</b>	
Bending of this system is only carried out by Wholesalers, Retail Support Specialists (RSS) and Distributors.	

All prices shown exclude VAT



# Heavy Duty Curtain Tracks

## System 6200

Supplied in satin silver as standard. Supplied with 6098 roller gliders, 6209 clamps and 6079 overlap arm as standard. Track available in 4, 5 and 6 metre lengths.

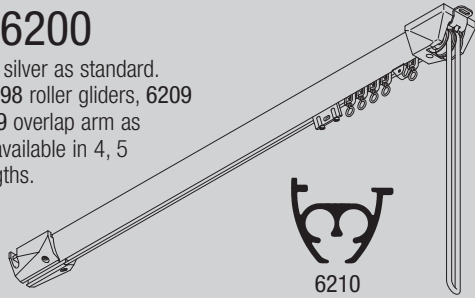

6210

## System 6370

Supplied in satin silver finish as standard. Profile available in 4, 5 and 6 metre lengths.

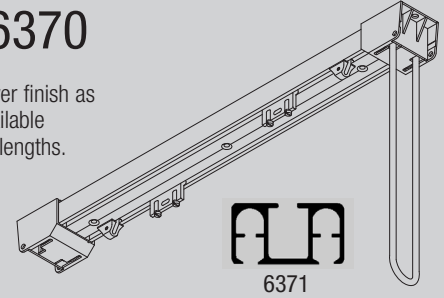

6371

	Price Ctgy.
<b>System Prices</b>	<b>C</b>

a) Recommended retail prices for assembled systems.

cm	Standard		Wave	
	Roller	£	Roller	£
300	583.71		686.49	
350	629.98		749.90	
400	674.98		812.03	
450	720.00		874.19	
500	764.96		936.27	
550	809.95		998.40	
600	854.99		1060.57	
650	899.99		1122.69	
700	944.98		1184.82	
750	990.05		1247.02	
800	1035.00		1309.10	
850	1080.00		1371.23	
900	1125.02		1433.40	
950	1169.99		1495.50	
1000	1214.98		1557.62	
1050	1260.01		1619.79	
1100	1304.99		1681.91	
1150	1350.08		1744.11	
1200	1395.08		1806.24	
1250	1440.08		1868.37	
1300	1485.06		1930.49	
1350	1530.03		1992.60	
1400	1575.04		2054.74	
1450	1620.03		2116.87	
1500	1665.04		2179.00	

For each additional 50cm add £44.56

Connecting bridge included over 6m. Right hand pull as standard.

For 2 tracks operated in parallel (System 6202), double price given above.

Above prices are for systems ready-assembled. Substantial savings can be made for self-assembly. Rail can be supplied in full lengths or cut-to-size with accessories separately.

<b>Rail and Standard Accessories</b>	<b>C</b>
--------------------------------------	----------

6210 Silver rail available in 4m, 5, 6m or cut-to-size.  
6209 Clamp, each, 10.  
6079 Overlap arm.  
6070 Cord 100 metres.  
6226 End support.  
6206 Endpiece set, each, 10.

	<b>A</b>
6007 Endstop, each 10. 6098 Roller glider with eye, 10, 100. 1128R Screw 36mm/1 1/2". No. 8 round head, 100.	

	<b>E</b>
10400 Cord retainer	

Special Lengths charged at the nearest 50cm increment above.

All prices shown exclude VAT

	Price Ctgy.
<b>Optional Accessories</b>	<b>C</b>

3239 Extension bracket.  
5829 2-hole fixing plate.  
6224 Nylon fixing clamp.  
6230 Mask.  
6203 Connecting bridge.  
6228 Double fixing plate.  
6190/6501 See 'Cubicle Track System 6100'.  
6190 Special Hanger Rod Assembly, silver.  
6501 Special 'V' Hanger Rod Assembly, silver.  
6214 Adjusted pilot runner.  
6227 Master pilot runner.

	<b>A</b>
6094 Roller glider with hook, 10, 100.	

<b>Colours</b>	<b>E</b>
Special order – see Page 70.	

<b>Bending</b>	<b>Max. trade discount</b>	<b>25%</b>
Standard right angle £109.50 Semi-circle or gradual curve 324.50		

<b>Tools</b>
7007 Demounting tool for 6224.

	Price Ctgy.
<b>System Prices</b>	<b>C</b>

a) Recommended retail prices for assembled systems.

6370S

cm	£
300	324.05
350	358.45
400	392.92
450	427.34
500	461.79
550	496.23
600	530.69
650	565.13
700	599.54
750	634.01
800	668.41
850	702.87
900	737.30
950	771.76
1000	806.20
1050	840.65
1100	875.08
1150	909.48
1200	943.96
1250	978.38
1300	1012.84
1350	1047.25
1400	1081.72
1450	1116.14
1500	1150.58

Connecting bridge included over 6m. Right hand pull as standard.

Above prices are for systems ready-assembled. Substantial savings can be made for self-assembly. Rail can be supplied in full lengths or cut-to-size with accessories separately.

<b>Rail and Standard Accessories</b>	<b>C</b>
--------------------------------------	----------

6371 Silver rail available in 4m, 5m, 6m or cut-to-size.  
6070 Cord.  
6214 Adjustable pilot runner.  
6227 Master pilot runner.  
6377 End piece set.

	<b>A</b>
28C Screw countersunk, No. 8 2"/50mm. 6086 Spring stop. 6098 Roller glider with eye. 10 per metre.	

	<b>E</b>
10400 Cord retainer	

Special Lengths charged at the nearest 50cm increment above.

	Price Ctgy.
<b>Optional Accessories</b>	<b>C</b>

3239 Extension bracket.  
6079 Overlap arm.  
6376 Connecting bridge.

	<b>A</b>
3599 Nylon hook. 6283 Roller glider. 6369 Insert (Face Fix).	

<b>Colours</b>	<b>E</b>
Special order – see Page 70.	

<b>Bending</b>	<b>Max. trade discount</b>	<b>25%</b>
Standard right angle £109.50 Semi-circle or gradual curve £324.50		





















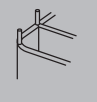

# Shower Rail Systems

## System 6100 System 6103

6101 rail in silver anodised finish.  
6103 in chrome effect,  
white and gold.

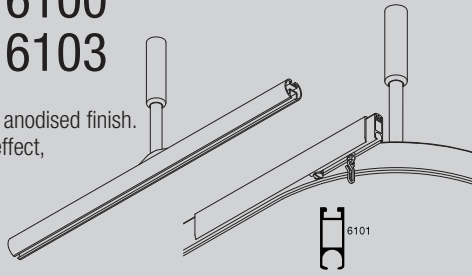

## System 1085

Supplied in satin  
silver finish as  
standard. Track  
profile available  
in 6 metre  
lengths only.

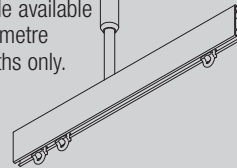

				Price Ctgy.
Ready, complete, pre-packed with all accessories, including hanger rod(s) where applicable.				<b>A</b>
<b>System Prices</b>				
		6100 Silver	6103 White	6103 Chrome effect/Gold
Model A	91cm	£45.95	£78.68	£105.90
	183cm	£72.35	£114.62	£178.69
	213cm	£81.67	£126.36	£202.39
	244cm	£92.82	£138.42	£226.92
Model B	76cmx76cm	£96.16	£144.33	£213.57
	91cmx91cm	£105.28	£156.16	£237.26
Model C-left Model D-right	168cmx76cm	£122.61	£180.30	£286.35
Model E	91cmx76cm x91cm	£172.13	£219.71	£365.02
Special shapes for Shower Rails Send template and drawings for quotation. No special shapes on 1085				<b>A</b>

**Colours**  
Special order – see Page 70.

**Bending for special  
shower rails**

6101 Angle bend £20.00  
Semi-circle or gradual curve £27.00  
6103 Angle bend £49.50  
Semi-circle or gradual curve £65.00

Max. trade  
discount

33 1/3%

		Price Ctgy.
<b>System Prices</b>		<b>A</b>
Ready, complete pre-packed with all accessories including hanger rod(s) where applicable.		
Model A	Satin silver finish only	
91cm	£23.13	
183cm	£34.47	
213cm	£38.33	
244cm	£42.19	
Model B		
76cm x 76cm	£47.80	
91cm x 91cm	£52.41	
Model C (Left) Model D (Right)		
168cm x 76cm	£60.87	
Model E		
91cm x 76cm x 91cm	£86.66	

No special shower shapes  
available - use 6100/6103 systems.  
Maximum size 1200mm x 1200mm

**Accessories**  
for 1085 when used as room  
divider, etc.  
Profile 1085

Silver available in 6m length or  
cut-to-size.  
3533/6146 Glider hook, 20.  
6146 Nylon hook, 12, 100.  
3610A Hanger rod assembly  
61cm assembly complete.  
3616 Ceiling support complete  
with sleeve 3612, stud 3611,  
washer, grub screw.  
3611 Ceiling stud only.  
3699 Track insert only.  
3652 Wall support with 3017  
endstop, grey.  
3533 Glider, Box 100.  
Outer, 25,000.  
3534 Glider in strip form.  
Outer, 1,000.  
3017 Endstop, each, 100.  
0715 Dustcap for 6650

**Colours**  
Other colours – see Page 70.

**Bending**

Angle bend £20.00  
Semi-circle or gradual curve, £27.00

Max. trade  
discount

33 1/3%

All prices shown  
exclude VAT



# Cubicle, Room Divider Systems

Hospital Cubicle System available through approved Distributors only.

## System 6100

Hospital Cubicle Safety Device System available through approved Distributors only – use in conjunction with System 6100

## System 6650

## System 6103

Supplied in satin silver finish and white in 6 metre lengths. Gold and chrome in 4 metre lengths

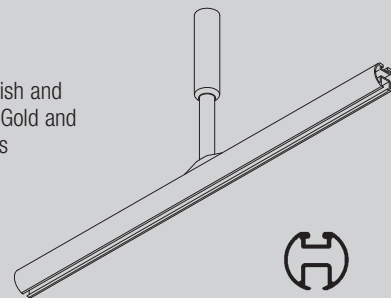

	Price Ctg.
<b>Accessories</b>	<b>A</b>
6101 Rail, silver, white. Available in following lengths: 4.5m, 4.75m, 5.0m, 5.25m, 5.5m, 6.0m, 6.75m. 7.5m available in silver only.	
6007 Endstop, silver, white, ea, 10.	
6055 Twist eye endstop, each, 10.	
6083 Glider, 100. Self-service sachets. Outer 25 x 25.	
6094 Roller glider with hook, 10, 100.	
6096 Strip glider. Outer, 1,000.	
6098 Roller glider with eye, 10, 100.	
6110 Dustcover for 6101, white, m.	
6124 Twist double ceiling fixing plate, silver, white, each.	
6137 Ceiling fixing plate (single), silver, white.	
6138 Ceiling fixing plate (double), silver, white.	
6143 Rotating glider, 20, 100.	
6146 Nylon hook only, 12, 100.	
6147 Nylon glider hook, 20.	
Box 500 (on strips). Outer 9,500.	
6160 Track insert for 6100, each.	
6190 Hanger rod assembly complete in silver and white, 61cm (2') or 91cm (3') or to order.	
6191 Hanger tube, silver and white, per metre.	
6188 Ceiling support complete with stud 6193, silver and white, 50mm, each.	
6192 Ceiling support complete with stud 6193, silver and white, 100mm.	
6194 Track insert.	
6197 Hanger joint sleeve.	
6283 Roller glider, 10, 100.	
6501 'V' Hanger assembly system, silver, white.	
6503 Wall brackets complete, silver, white.	
25mm long with 50mm projection.	
50mm long with 50mm projection.	
100mm long with 50mm projection.	
200mm long with 50mm projection.	
50mm long with 100mm projection.	
100mm long with 100mm projection.	
75mm long with 150mm projection.	
6512 Connecting bridge, silver, white.	
6514 T-junction, single, silver, white.	
6524 Diagonal fixing support, silver, white.	
6525 Double 'T' junction, each, silver, white.	
6609 Wall support, grey.	
6611 End cover with screw, white, each.	
6625A Complete fixing sleeve, silver, white.	
6199 Internal connecting bridge.	
6187 Dummy ceiling support sleeve, silver, white.	
6175 Mini hanger, silver, white.	
0554 Loading device access.	
0553 Connecting bridge for loading device.	
0552 Transfer unit for loading device.	
<b>Note:</b> For bent cubicle rail orders a crating charge of £39.00 is applicable.	

	Price Ctg.
<b>Accessories</b>	<b>A</b>
6675 Safety device.	
6655 Wall support.	
6677 V-hanger safety device.	
6663 Wall bracket connector plate.	
6666 Safety connecting bridge.	
6671 Washer insert for wall support.	
6672 Cover for washer insert.	
0785 Acrylic disc for wall support.	

	Price Ctg.
<b>6103 Rail, silver, white, gold, chrome effect available in 6m lengths.</b>	<b>A</b>
0550A Wall supports, chrome and gold, pair.	
6007 Endstop, silver, white, each, 10.	
6065 Twist eye endstop, each, 10.	
6083 Glider, 100. Self-service sachets. Outer 25 x 25.	
6094 Roller glider with hook, 10, 100.	
6096 Strip glider. Outer 1,000.	
6098 Roller glider with eye, 10, 100.	
6110 Dustcover, metre, white.	
6124 Twist double ceiling fixing plate, silver, white, each.	
6143 Rotating glider, 20, 100.	
6146 Nylon hook only, 12, 100.	
6147 Nylon glider hook, 20.	
Box 500 (on strips). Outer, 9,500.	
6188 Ceiling support complete with stud 6193, 50mm, gold, white, silver and chrome.	
6190 Hanger rod assembly complete in silver, white, gold, chrome and other powder-coated colours.	
61cm (2') 91cm (3') or to order.	
6191 Hanger tube, silver, white, gold and chrome, per metre.	
6192 Ceiling support complete with stud 6193, 100m each, silver, white, gold.	
6194 Track insert.	
6197 Hanger joint sleeve, silver, white.	
6283 Roller glider, 10, 100.	
6501 'V' Hanger assembly system, silver, white.	
6503 Wall brackets complete, silver, white	
25mm long with 50mm projection.	
50mm long with 50mm projection.	
100mm long with 50mm projection.	
200mm long with 50mm projection.	
50mm long with 100mm projection.	
100mm long with 100mm projection.	
75mm long with 150mm projection.	
6511 White plastic cover.	
6514M T-junction, single, silver, white.	
6525 Double 'T' junction, silver, white.	
6527 Wall support, metal, white.	
6620 Wall support complete, each, 10. Grey, each, 10. White.	
6625A Complete fixing sleeve, silver, white.	
6630 End cover, grey, white.	
6631 90° connector piece, grey, white.	
6635 Internal connecting bridge.	
6521 External connecting bridge, silver, white.	
6524 Diagonal fixing support, silver, white.	
6175 Mini hanger.	

	Price Ctg.
<b>Colours</b> (all colours except white, chrome and gold special order – see page 70).	<b>E</b>
<b>Bends</b>	<b>331/s%</b>
Max trade discount	
Angle bend £49.50	
Semi-circle or gradual curve, £65.00	

All prices shown exclude VAT



# Electrically Operated Curtain Tracks

## System 5100

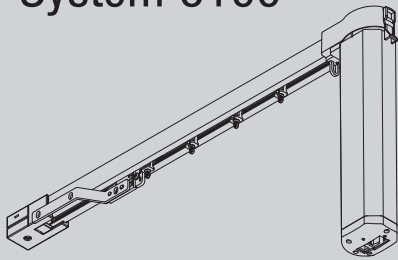

System 5100 Base  
System 5100R with Remote Control  
System 5100T with Timer  
System 5100TC with Total Control

## System 5300

Electrically Operated  
Profile only 5301  
Supplied in silver and white.

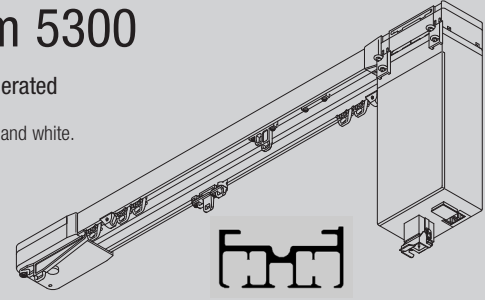

	Price Ctg.
<b>System Prices</b> Ready complete and assembled in white only.	
<b>System 5100</b>	<b>A</b>
<b>Base</b>	
<b>Length</b>	
cm	£
100	425.82
150	443.76
200	461.77
250	479.70
300	497.64
350	515.57
400	533.51
450	551.44
500	569.38
<b>System 5100R with Remote Control</b>	<b>A</b>
<b>Length</b>	
cm	£
100	481.19
150	499.13
200	517.06
250	535.00
300	552.93
350	570.87
400	588.80
450	606.81
500	624.75
<b>System 5100T with Timer</b>	<b>A</b>
<b>Length</b>	
cm	£
100	559.78
150	577.71
200	595.65
250	613.58
300	631.52
350	649.45
400	667.39
450	685.32
500	703.26
<b>System 5100TC Total Control option</b>	<b>A</b>
<b>Length</b>	
cm	£
100	615.15
150	633.08
200	651.02
250	668.95
300	686.89
350	704.82
400	722.75
450	740.69
500	758.62

All prices shown exclude VAT

	Price Ctg.
<b>System 5100 (all models)</b> For systems assembled with wave gliders please add the following supplement to standard system price.	<b>A</b>
<b>Length</b>	
cm	60mm 80mm
100	30.59 26.18
150	45.89 39.27
200	61.18 52.35
250	76.48 65.45
300	91.77 78.54
350	107.08 91.63
400	122.38 104.73
450	137.68 117.82
500	152.97 130.91
<b>Standard Accessories</b>	<b>A</b>
18R Screw 25mm	
3133 Extension Bracket Cover	
3136 Fixed Extension Bracket 100mm. (4")	
5190 Motor	
10815 Cover White	
10823 Belt Connector Arm	
10824 Belt Connector Pin	
10825 Drive Belt	
10836 Hook White	
10867 M4 x 16 screw	
10931 Roller Glider	
10933 Belt Return & Motor Holder Set White	
10936 Overlap Arm Set	
10940 Belt Return	
10945 Endstop	
10949 1 Channel Wall Transmitter White	
1148C Countersunk screw No.8 31mm	
0286 Cable Clips	<b>C</b>
10926 Clamp	
10925 Profile	
<b>Optional Accessories</b>	<b>A</b>
3133L Long Extension Bracket Cover	
3135 Fixed Extension Bracket 75mm. (3")	
3137 Fixed Extension Bracket 125mm.	
3138 Fixed Extension Bracket 150mm. (6")	
3139 Fixed Extension Bracket 200mm. 8")	
6349 Wave Curtain Tape FR	
6363 Webbing Tape 70mm. For Wave Curtain 100m	
10905 Glider Cord 80mm for 6.5mm Channel	
10906 Glider Cord 60mm for 6.5mm Channel	
10943 Connecting Bridge	
10946 1 Channel Transmitter White	
10947 2 + 1 Channel Transmitter	
10948 6 + 1 Channel Transmitter	
10950 2 + 1 Channel Wall Transmitter	
10951 5 + 1 Channel Wall Transmitter	
11092 Timer White	
0722 2mm Allen Key	<b>E</b>
<b>Bending</b>	<b>Max. trade discount 33 1/3%</b>
Max 2 no. 90° bends or one curve. £136.50.	
<b>Note:</b> Autoglide is made-to-measure and cannot be cut down.	

	Price Ctg.
<b>System Prices</b> Ready complete and assembled	<b>C</b>
<b>Length</b>	<b>£</b>
M	
2	2994.72
3	3105.46
4	3216.20
5	3326.96
6	3437.68
7	3548.43
8	3659.20
9	3769.95
10	3880.71
11	3991.48
12	4102.21
13	4212.93
14	4323.73
15	4434.48
16	4545.24
17	4655.98
18	4766.75
19	4877.51
20	4988.26
21	5099.03
22	5209.74
23	5320.51
24	5431.26
25	5542.06
Track lengths between those specified will be charged at the rate for the nearest metre above. Satin silver or white as standard.	
<b>Standard Accessories</b>	<b>C</b>
0562 Lead with in-line connector	
5301 Profile, 6 metre length silver, white.	
5304 Endpiece set, white, grey.	
5310 Return set, white, grey.	
5312 Endstop.	
5317 Master carrier set.	
5318 Motor support.	
5320 Clamp.	
5302 Cylinder belt, per metre.	
5360 Motor.	
6098 Roller glider, at 10 per metre, 10, 100.	<b>A</b>
6086 Spring stop, each, 10, 100.	

	Price Ctg.
<b>Optional Accessories</b>	<b>A</b>
0565 Non-latching switch.	
6094 Roller glider with hook, 10, 100.	
0270 RACUB module.	<b>C</b>
0578 Recess pattress, metal.	
5319 Connecting bridge.	
5670 Overlap arm (single stack).	
3239 Fixed extension bracket.	
<b>Colours</b> Other colours special order – see page 70.	<b>E</b>
<b>Bends</b>	<b>Max. trade discount 25%</b>
For each bend add the following to above system price: Single angle bend £325.50 Semi-circle or gradual curve £595.50	
<b>Multiple System Operation</b> A wide range of multiple operation methods are available, including low voltage control, radio/remote control and mixed systems. Can be controlled through a smartphone, tablet or desktop with the Silent Gliss app 'Move'.	<b>C</b>
Please consult the Silent Gliss catalogue.	

All prices shown exclude VAT







# Electrically Operated Curtain Tracks

## System 5800

Electrically Operated



5810

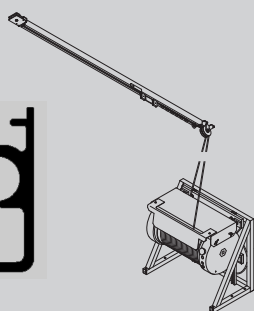

System Prices			Price Ctgy.
Ready complete and assembled (as far as possible depending on transport requirements).			C
Length M	Price Single Track £	Price 2 Parallel Tracks £	
12	14880.77	20476.98	
13	15188.37	21092.17	
14	15471.19	21657.83	
15	15754.02	22223.47	
16	16036.85	22789.13	
17	16319.68	23354.78	
18	16602.52	23920.46	
19	16910.10	24535.64	
20	17192.93	25101.30	
21	17475.76	25666.96	
22	17758.59	26232.61	
23	18041.42	26798.27	
24	18324.24	27363.92	
25	18631.85	27979.13	
26	18914.68	28544.79	
27	19197.51	29110.44	

System 5800 can cover windows up to 60m if pair stacked. On lengths of this size Silent Gliss advice should be sought but as a guide price for each metre above 27m the following should be added:

Single width £282.82

Two tracks in parallel £565.66

Track lengths between those specified will be charged at the rate for the nearest metre above. Price includes 6209 Top fix clamps, 5821/22 Wall mounting for motor, 5811 Overlap, 5809 Roller gliders at 5 per metre and where length exceeds 6 metres 6203 Connecting bridge. 5741 Plug, 5742 Surface socket and 0615 plastic switch with recess box. Earth is required.

### Standard Accessories

- 5806 Pilot Runner.
- 5809 Roller glider, 10.
- 5810 Silver profile only.
- 5824 Endstop.
- 5811 Overlap.
- 5814 Cable, metre.
- 5815 Cord guide return.
- 5816 Cord guide.
- 5834 Cable connector.
- 6203 Connecting bridge.
- 6209 Clamp, each, 10.

Optional Accessories			Price Ctgy.
0578 Recess pattress, metal.			C
0615 Latching switch			
6228 Double fixing plate.			
5829 2 Hole fixing plate.			
5813 Floor mounting frame.			
Colours			E
Special quotation.			
Bending		Max trade discount	25%
Radius cm	Each £		
32-99	268.50		
99-349 over 350	397.50 519.00		
Remote/Multiple System Operation			C
Must not be wired in parallel. For information consult Silent Gliss			

All prices shown  
exclude VAT



# Switches, Remote Control & Multiple Operation of Motorised Systems

## System 0450

Radio controlled systems

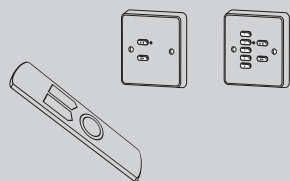

## System 9940

Radio controlled systems

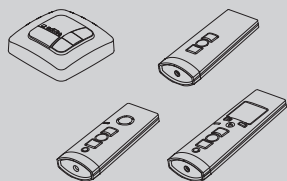

## Other Accessories

All costs for systems indicated in this section are exclusive of curtain/blind systems and need to be added for total cost. On-site wiring costs are also excluded although advisory service is available. To assist choosing the correct equipment please see application chart in the back of the price list.

	Price Ctg.
<b>System 0450</b>	<b>C</b>
Radio control system, up to 255 room and blind addresses, individually or simultaneously. Use with mains electric systems (motor types A & B). Low voltage option (motor type C) available on request.	
0918 Control Module (motor type A)	£272.27
0919 Control Module (motor type B)	£272.27
0907 Control Module (low voltage motor type C)	£293.94
0913BS Single-channel wall switch – brushed silver	£213.22
0913MP Single-channel wall switch – mirror polished	£213.22
0913BR Single-channel wall switch – brass	£244.49
0914BS Eight-channel wall switch – brushed silver	£213.22
0914MP Eight-channel wall switch – mirror polished	£213.22
0914BR Eight-channel wall switch – brass	£244.49
0915 Single-channel hand-held remote	£202.87
0939 Multi-channel transmitter	£263.78

	Price Ctg.
<b>Optional Accessories</b>	<b>C</b>
0917 White pattress box	£19.30

	Price Ctg.
<b>System 9940</b>	<b>C</b>
9068 Single-channel receiver	£362.74
9944 Single-channel receiver, non latching	£278.13
9945 Single-channel receiver, latching	£251.49
9946 Single-channel wall switch	£146.39
9947 Control Unit DC 24V	£164.35
9948 Single-channel programmable wall switch with timer	£366.00
10297 Solar sensor	£343.84
10298 Sensor	£310.73
10300 Single-channel hand-held remote	£204.48
10302 5+1 channel hand-held remote	£204.48
10303 10+2+1 channel hand-held remote	£249.20
10804 15+5+1 channel hand-held receiver	£249.20
Uplift for integrated receiver in dim-out, Roller and Roman Blinds	£164.31
Engraving of above remotes is available at £39.91 per remote. Delivery: 4 weeks.	

	Price Ctg.
<b>Move Server Set</b>	<b>C</b>
9960 Set (consists of server and transmitter stick)	£964.00
9961 Transmitter stick	£352.67

	Price Ctg.
<b>Fixed switches for mains control</b>	<b>C</b>
Switches are available single or in banks as below. Add switches price to price of system. Switches are designed for recess fixing.	
<b>Non-latching</b>	
<b>1 Gang Switches</b>	
0565/W White plastic	£94.47
<b>2 Gang Switches</b>	
0566/W White plastic	£163.56
<b>3 Gang Switches</b>	
0567/W White plastic	£254.70
<b>4 Gang Switches</b>	
0568/W White plastic	£322.88
<b>6 Gang Switches</b>	
0569/W White plastic	£488.81
<b>Latching</b>	
<b>1 Gang Switches</b>	
0615/W White plastic	£51.02
<b>2 Gang Switches</b>	
0616 White plastic	£68.79
<b>3 Gang Switches</b>	
0617 White plastic	£111.76
<b>4 Gang Switches</b>	
0618 White plastic	£134.40
<b>6 Gang Switches</b>	
0619 White plastic	£186.21
9952 Hard wired timer switch	£221.92

	Price Ctg.
<b>Exts</b>	<b>C</b>
0934 Antenna	£147.72
5736 Relay	£137.54
0521 Motor Lead	£90.55
0570 Volt free switching	£178.44

	Price Ctg.
<b>Tools</b>	<b>E</b>
0539 Crimping Tool	

All prices shown exclude VAT

All prices shown exclude VAT

All prices shown exclude VAT



# Roman Blind Systems

## System 2020

Chain operated headrail system for Roman Blinds. For light to medium weight applications.

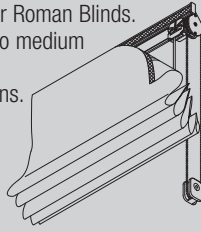

## System 2120

Chain operated headrail system for Roman Blinds. For medium to heavy weight applications.

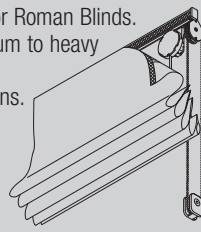

## System 2320

Chain operated headrail system for Roman Blinds with new wind up mechanism. For light to medium weight applications.

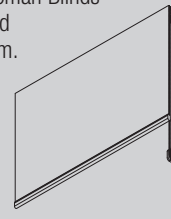

## System 2330

Chain operated (4:1 geared) roman blind system for residential and contract applications. Suitable for light to medium weight applications.

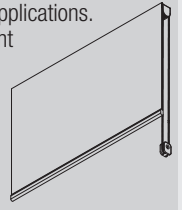

		Price Ctgy.
<b>2020 System supplied ready assembled</b>	<b>A</b>	
Total max. curtain weight 3kg incl. any weighting. Maximum width: 2.5m Maximum drop: 3.0m		
<b>System width</b>		
<b>cms</b>	<b>£</b>	
100	114.40	
125	132.65	
150	150.95	
175	169.17	
200	187.37	
225	205.63	
250	223.88	
Above prices are based on standard accessories detailed below.		

		Price Ctgy.
<b>Standard Accessories</b>	<b>A</b>	
2032 Tape spool cassette (with 3m lift tape) each 10, 100, 250. 2049 Gear drive, each, 10, 100. 2059 Safety clip, 10. 2111 Hexagonal bar, 6m length, outer of 50 lengths. 2116 Velcro headrail, 5m length. 2131 End cover, each, 10. 3630 Universal bracket, each, 10, 100. 4845 Metal bead chain, 125m reel. 3056 Tape centralizer, 10.		
-----		
2865 Twin chain connector, each.	<b>C</b>	
-----		
10400 Cord retainer.	<b>E</b>	

		Price Ctgy.
<b>Optional Accessories</b>	<b>A</b>	
0549 Touch and close pencil pleat tape for Austrian Blinds. 0877 Breakaway hook and latch set. 0878 Breakaway ring set (soft fold). 0879 Breakaway ring tape (soft fold). 2006 Bottom weight bar, 4m. 2048 Bead chain, white, 100m reel. 2164/2164T Ring tape, 50m. 2196 Lead weight tape, 50m. 2539 Velcro pile section, 25m, 100m. 2826 Chain connector, each, 10. 3055 Hook, each, 10. 3069 Breakaway rod cover (hard fold). 3133 Bracket cover. 3133L Bracket cover long. 3134-9 Fixed extension brackets. 3603 Top fix brackets, each, 10, 100. 3655 Long universal bracket. 3660 Extra long universal bracket. 4845BR Metal bead chain, brass.		

		Price Ctgy.
<b>Tools</b>	<b>E</b>	
0679 Connector tongs.		

All prices shown exclude VAT

		Price Ctgy.
<b>2120 System supplied ready assembled</b>	<b>A</b>	
Total max. curtain weight 8kg incl. any weighting. Maximum width: 4.0m Maximum drop: 6.0m		
<b>System width</b>		
<b>cms</b>	<b>£</b>	
100	157.99	
125	181.89	
150	212.51	
175	243.82	
200	267.71	
225	298.49	
250	329.30	
275	353.20	
300	384.02	
325	414.86	
350	450.05	
375	476.54	
400	507.37	
Above prices are based on standard accessories detailed below.		

		Price Ctgy.
<b>Standard Accessories</b>	<b>A</b>	
2049 Gear drive, each, 10, 100. 2081 Take-up reel, each, 10. 2059 Safety clip, 10. 2111 Hexagonal bar, 6m length, outer of 50 lengths. 2163 Flat drawing tape, per m, 100m 2211 Velcro headrail, 6m, length. 2179 End cover, each, 10. 3630 Universal bracket, each, 10, 100. 4845 Metal bead chain, 125m reel.		
-----		
2865 Twin chain connector, each.	<b>C</b>	
-----		
10400 Cord retainer.	<b>E</b>	

		Price Ctgy.
<b>Optional Accessories</b>	<b>A</b>	
0549 Touch and close pencil pleat tape for Austrian Blinds. 0877 Breakaway hook and latch set. 0878 Breakaway ring set (soft fold). 0879 Breakaway ring tape (soft fold). 2006 Bottom weight bar, 4m. 2048 Bead chain, white, 100m reel. 2072A Universal joint, each. 2164/2164T Ring tape, 50m. 2196 Lead weight tape, 50m. 2539 Velcro pile section, 25m, 100m. 3069 Breakaway rod cover (hard fold). 3133 Bracket cover. 3133L Bracket cover long. 3134-9 Fixed extension brackets. 3603 Top fix brackets, each, 10, 100. 3655 Long universal bracket. 3660 Extra long universal bracket. 4845BR Metal bead chain, brass.		

		Price Ctgy.
<b>Tools</b>	<b>E</b>	
0679 Connector tongs.		

		Price Ctgy.
<b>2320 System supplied ready assembled</b>	<b>A</b>	
Max curtain weight 2.5kg inc any weighting. Maximum width: 3.0m Maximum drop: 3.0m		
<b>System width</b>		
<b>cms</b>	<b>£</b>	
100	118.64	
125	136.23	
150	153.79	
175	171.37	
200	188.96	
225	206.55	
250	224.16	
275	241.74	
300	259.32	
Above prices are based on standard accessories detailed below.		

		Price Ctgy.
<b>Standard Accessories</b>	<b>A</b>	
2221 Velcro Tape per m, 100m. 2322 Pin. 2327 Adapter. 2341 Wheel for steel bead chain. 2216 Cord (diameter 0.85mm) 10m, 50m, 100m. 2321 Profile. 2323 Shell. 2328 Adapter. 2334 Sleeve. 2335 Drive case 1:1. 2337 End cover. 2343 Universal bracket. 4845 Steel bead chain (diameter 4.6mm) 125m reel. 2336 Support. 2339 Cover. 8214 Drive Shaft.		
-----		
2865 Twin chain connector (diameter 4.6mm)	<b>C</b>	
-----		
10400 Cord retainer.	<b>E</b>	

		Price Ctgy.
<b>Optional Accessories</b>	<b>A</b>	
0877 Breakaway hook and latch set. 0878 Breakaway ring set (soft fold). 0879 Breakaway ring tape (soft fold). 2006 Bottom bar 1m, 5m 2016 Bottom bar 1m, 5m 2048 Plastic bead chain (diameter 4.5mm) 100m reel 2103T Transparent loop tape 2109 Bottom Ring 2144 Cross Rail 2164 Ring Tape 2333 Wheel for plastic bead chain 2539 Touch and close pile section, 25m, 100m 2616 Bracket (40.8mm) 2872 Plastic bead chain (diameter 4.6mm) 100m reel 3069 Breakaway rod cover (hard fold). 3133 Bracket cover (60mm) 3133L Bracket cover long. 3134 Bracket (60mm) 3135 Bracket (80mm) 3136 Bracket (100mm) 3137 Bracket (120mm) 3138 Bracket (150mm) 3139 Bracket (200mm) 4845BR Metal bead chain, brass Side-guide option available at an additional £40.47		
-----		
10480 Child safety device (metal bead chain)	<b>E</b>	
10481 Child safety device (plastic bead chain)	<b>E</b>	

		Price Ctgy.
<b>2330 System supplied ready assembled</b>	<b>A</b>	
Max curtain weight 4.5kg inc any weighting. Maximum width: 3.0m Maximum drop: 3.0m		
<b>System width</b>		
<b>cms</b>	<b>£</b>	
100	176.23	
125	197.07	
150	217.89	
175	238.68	
200	259.51	
225	279.43	
250	301.15	
275	321.95	
300	342.76	
Above prices are based on standard accessories detailed below.		

		Price Ctgy.
<b>Standard Accessories</b>	<b>A</b>	
2221 Velcro Tape per m, 100m. 2322 Pin. 2327 Adapter. 2216 Cord (diameter 0.85mm) 10m, 50m, 100m. 2321 Profile. 2323 Shell. 2329 Adapter. 2336 Sleeve. 2337 End cover. 2343 Universal bracket. 4845 Steel bead chain (diameter 4.6mm) 125m reel. 2326 Drive Case 4:1 2325 Cover. 8214 Drive Shaft. 2046 Driving Pulley. 2047 Driving Sleeve.		
-----		
2865 Twin chain connector (diameter 4.6mm)	<b>C</b>	
-----		
10400 Cord retainer.	<b>E</b>	

		Price Ctgy.
<b>Optional Accessories</b>	<b>A</b>	
0877 Breakaway hook and latch set. 0878 Breakaway ring set (soft fold). 0879 Breakaway ring tape (soft fold). 2006 Bottom bar 1m, 5m 2016 Bottom bar 1m, 5m 2048 Plastic bead chain (diameter 4.5mm) 100m reel 2103T Transparent loop tape 2109 Eyelet 2144 Cross Rail 2164 Ring Tape 2539 Touch and close pile section, 25m, 100m 2616 Bracket (40.8mm) 2872 Plastic bead chain (diameter 4.6mm) 100m reel 3069 Breakaway rod cover (hard fold). 3133 Bracket cover (60mm) 3133L Bracket cover long. 3134 Bracket (60mm) 3135 Bracket (80mm) 3136 Bracket (100mm) 3137 Bracket (120mm) 3138 Bracket (150mm) 3139 Bracket (200mm) 4845BR Metal bead chain, brass Side-guide option available at an additional £40.47		
-----		
10480 Child safety device (metal bead chain)	<b>E</b>	
10481 Child safety device (plastic bead chain)	<b>E</b>	



# Roman Blind Systems

# Austrian, Roman & Festoon Blind Systems

## System 2345

Battery Operated

Battery operated radio controlled for Roman Blinds

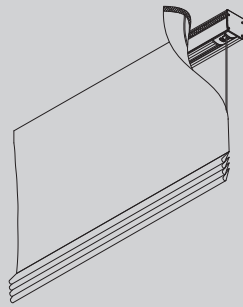

## System 2350

Electrically Operated

For medium/heavy Roman Blinds.

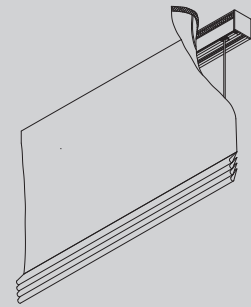

	Price Ctg.
<b>Battery operated System 2345 supplied ready assembled</b>	<b>C</b>
Total maximum curtain weight 2.5kg. Maximum width 6 metres. Maximum drop 6 metres, maximum total surface area 36m <sup>2</sup> depending on curtain weight. Minimum width 60cm. Hardware only cost.	
<b>SYSTEM WIDTHS (cms)</b>	<b>£</b>
100	417.12
125	436.44
150	460.32
175	479.58
200	502.38
225	528.30
250	545.58
275	571.44
300	588.72
325	607.98
350	631.86
375	651.12
400	673.98
425	699.84
450	717.12
475	742.98
500	760.26
525	779.58
550	803.46
575	822.72
600	840.00
Above prices are based on Standard Accessories detailed below.	
<b>Standard Accessories</b>	<b>A</b>
1148C No.8 Cross Head Woodscrew	
2216 Cord	
2221 Velcro Tape	
2351 Profile White for system 2345	
2352 Profile silver for system 2345	
3069 Breakaway Rod Cover	
10949 1 Channel Wall Transmitter White	
-----	
2353 Motor cover for system 2345	<b>C</b>
2354 Cover for system 2345	
2357 Pin for system 2345	
2358 Shell for system 2345	
2359 Support for system 2345	
2361 Adaptor for system 2345	
2363 Wall/Ceiling Bracket	
2368 Motor Adaptor Plate for SG2345	
3003 Clamp	
11071 Motor Drive for SG2345	
11074 Tube adaptor for SG2345	
11076 1.2nm Motor for 2345	
11077 Battery Box for Motor 11076	
11085 Battery Box Holder	
11099 Battery for 2345	
All prices shown exclude VAT	

	Price Ctg.
<b>Optional Accessories</b>	<b>A</b>
0877 Breakaway bottom bar set	
0879 Breakaway ring set (soft fold)	
2135 Breakaway ring tape (soft fold)	
2136 Steel Rod	
3069 Breakaway rod cover (hard fold)	
2004 Bottom Bar	
2006 Weight bar	
3133 Bracket Cover	
3133L Extended Bracket Cover for 3137/8/9	
3134 Extension Bracket (60mm)	
3135 Extension Bracket (80mm)	
3136 Extension Bracket (100mm)	
3137 Extension Bracket (120mm)	
3138 Extension Bracket (150mm)	
3139 Extension Bracket (200mm)	
3271 Adjustable bracket base	
3273 Adjustable bracket base	
10946 Radio hand-held transmitter 1 channel	
10947 Radio hand-held transmitter 2 + 1 channel	
10948 Radio hand-held transmitter 6 + 1 channel	
10950 Radio wall transmitter 2 channel	
10951 Radio wall transmitter 5 + 1 channel	
11092 Timer White	
-----	
2362 Wire Holder	<b>C</b>
2521 Bracket	
8235 Wire Base Short	
8236 Wire Base Long	
8237 Wire Holder	
8249 Locking ring	

	Price Ctg.
<b>Electrically operated System 2350 for straight vertically-hung Austrian, Roman and Festoon Blinds</b>	<b>C</b>
Total maximum curtain weight 15kg. Maximum width 6 metres. Maximum drop 6 metres, maximum total surface area 36m <sup>2</sup> depending on curtain weight. Minimum width 60cm.  Hardware cost only.	
<b>SYSTEM WIDTHS (cms)</b>	<b>£</b>
100	701.72
150	735.83
200	769.99
250	804.13
300	838.28
350	872.41
400	906.58
450	940.72
500	974.85
550	1009.01
600	1043.14
<b>Components supplied separately.</b> 2510 Velcro <sup>®</sup> insert rail (5 metre length).	
-----	
3003 Clamp, 10, 100.	<b>A</b>
<b>Optional Accessories</b>	<b>A</b>
0877 Breakaway hook and latch set.	
0878 Breakaway ring set (soft fold).	
0879 Breakaway ring tape (soft fold).	
2004 Bottom bar	
2006 Bottom bar 1m, 5m	
2103T Transparent loop tape	
2109 Eyelet	
2144 Cross Rail	
2164 Ring Tape	
2539 Touch and close pile section, 25m, 100m	
2616 Bracket (40.8mm)	
2872 Plastic bead chain (diameter 4.6mm) 100m reel	
3069 Breakaway rod cover (hard fold).	
3133 Bracket cover (60mm)	
3133L Bracket cover long.	
3134 Bracket (60mm)	
3135 Bracket (80mm)	
3136 Bracket (100mm)	
3137 Bracket (120mm)	
3138 Bracket (150mm)	
3139 Bracket (200mm)	
-----	
2363 Wall/ceiling bracket	<b>C</b>
2521 Bracket (49.6mm)	

	Price Ctg.
<b>Remote/Multiple System Operation</b>	<b>C</b>
For system operation possibilities refer to table on page 84	
<b>Side-guide option available at an additional cost of £59.08.</b>	
System 9940 and 0450 Radio Controls are suitable for use with 2350. See page 24.	
For Integrated Receiver for use with System 9940 controls, please add £164.31 to above prices.	<b>C</b>



# Made-to-measure Roman Blinds

Prices below comprise the complete system made-to-measure, ready-to-hang on either System 2320 or 2330 with the chosen fabric.

Maximum width 3m, maximum drop 3m and maximum weight 4.5kg.

Width ► Drop ▼ cm	Breeze Freshtex Ultralight Someo		Colorama 1 Leviso Somnia		Colorama 2 Natural Sunset		Freshtex Light Silente 20 Twist		Freshtex Linlook		Price Category 'C'	Width ▼ Drop cm
	100cm	120cm	140cm	160cm	180cm	200cm	220cm	240cm	260cm	280cm		
90	417.44	455.57	493.57	531.83	569.94	608.06	646.19	684.32	722.42	760.54	798.67	90
120	441.86	484.61	527.39	570.13	612.92	655.69	698.45	741.20	783.97	826.75	869.49	120
140	466.23	513.66	561.07	608.49	655.90	703.32	750.71	798.11	845.53	892.94	940.33	140
160	490.65	542.69	594.78	646.80	698.87	750.90	802.95	855.01	907.05	959.12	1011.15	160
180	515.07	571.78	628.45	685.16	741.84	798.54	855.22	911.92	968.60	1025.30	1081.98	180
200	539.47	600.81	662.17	723.49	784.84	846.15	907.46	968.82	1030.14	1091.48	1152.79	200
220	563.91	629.87	695.85	761.82	827.80	893.77	959.76	1025.73	1091.69	1157.66	1223.65	220
240	588.34	658.93	729.54	800.15	870.76	941.38	1012.06	1082.64	1153.25	1223.84	1294.52	240
260	612.77	687.99	763.23	838.48	913.71	988.99	1064.36	1139.55	1214.80	1290.02	1365.38	260
280	637.21	717.05	796.92	876.81	956.67	1036.61	1116.65	1196.46	1276.35	1356.20	1436.25	280
300	661.64	746.12	830.61	915.14	999.63	1084.22	1168.95	1253.37	1337.90	1422.38	1507.11	300

Width ► Drop ▼ cm	Colorama 1 Alu Newlife 1		Colorama 2 Bioactive Newlife 2		Deep Reflex	Freshtex Dimout Silente 10		Freshtex Vision Linea		Price Category 'C'	Width ▼ Drop cm	
	100cm	120cm	140cm	160cm		180cm	200cm	220cm	240cm			260cm
90	521.00	577.57	634.13	690.71	747.30	803.86	860.43	916.99	973.57	1030.13	1086.72	90
120	557.67	621.29	684.96	748.59	812.26	875.90	939.55	1003.20	1066.83	1130.49	1194.13	120
140	594.30	665.06	735.77	806.52	877.22	947.95	1018.68	1089.41	1160.12	1230.88	1301.55	140
160	630.96	708.79	786.61	864.39	942.21	1019.99	1097.81	1175.60	1253.41	1331.24	1409.04	160
180	667.65	752.53	837.41	921.17	1007.17	1092.04	1176.94	1261.84	1346.72	1431.60	1516.47	180
200	704.29	796.25	888.21	980.20	1072.14	1164.11	1256.04	1348.03	1440.00	1531.96	1623.91	200
220	740.95	839.99	939.04	1038.10	1137.10	1236.16	1335.20	1434.26	1533.29	1632.31	1731.35	220
240	777.61	883.74	989.87	1096.00	1202.06	1308.20	1414.36	1520.50	1626.58	1732.66	1838.80	240
260	814.26	927.48	1040.70	1153.90	1267.02	1380.25	1493.53	1606.73	1719.87	1833.00	1946.25	260
280	850.92	971.23	1091.53	1211.80	1331.97	1452.29	1572.69	1692.96	1813.16	1933.35	2053.70	280
300	887.58	1014.97	1142.36	1269.71	1396.93	1524.34	1651.85	1779.20	1906.45	2033.69	2161.14	300

Please note that blinds with a total weight between 2.5kg and 4.5kg will be specified with System 2330 at an additional cost of £71.18. For manually operated blinds exceeding 4.5kg in weight please consult Silent Gliss for alternative systems.

Please note, if 2345 Battery Operated system is required, please add £315.00 to the cost of the blinds above. For additional controls for the 2345, please see optional accessories on page 26. If 2345 is being supplied with above fabrics, please check fabric weight is within system limitations.

If 2350 Electrically Operated system is required please add £551.43 to the cost of the blinds above for standard motor. For integrated motor option for use with 9940 controls, please add £713.95.

**ONLY** the following fabrics can be lined. For a Blackout lining add 10%.  
Deep, Freshtex Dimout, Sunset, Freshtex Linlook.



# Sliding Panels

## System 2640/2650 Panel Fold

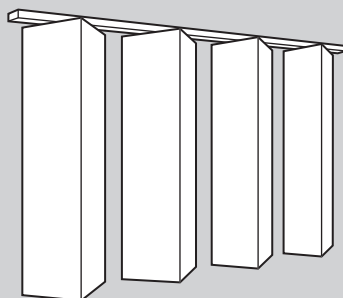
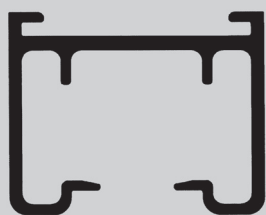

Silent Gliss Panel Fold Systems 2640 and 2650 are delivered made-to-measure, ready assembled in **white**.

To specify the complete system determine firstly the overall width of the system required. The actual sizes and quantities of panels are determined by special Silent Gliss software. However, in most circumstances there will be a choice between small, medium or large. You should also specify where panels need to be stacked in the open position; left, right or pair stack (same price applies for all stacking methods).

Panel Fold is only available as a complete system including fabric panels.

HARDWARE PRICES						Price Ctg.
System 2640 – Crank		System Electric (motor 9090)		System Electric (integrated radio receiver motor 9091)		C
	£		£		£	
150cm	383.59	150cm	1333.55	150cm	1483.16	
200cm	481.95	200cm	1416.78	200cm	1566.39	
250cm	580.31	250cm	1499.97	250cm	1649.60	
300cm	678.67	300cm	1583.22	300cm	1732.84	
350cm	777.03	350cm	1666.43	350cm	1816.07	
400cm	875.40	400cm	1749.67	400cm	1899.29	
450cm	973.75	450cm	1779.51	450cm	1982.51	
500cm	1072.60	500cm	1860.30	500cm	2065.72	

### PRICES PER FABRIC PANEL (max 3m drop)

	Price Group 1	Price Group 2	Price Group 3
Up to 60cm wide	£206.75	£236.53	£306.81
Over 60cm wide	£266.35	£308.97	£422.52

Recess profiles are available for both Panel Fold systems:

System 2650 - 2932

System 2640 - 2932

### Fabric Price Group 1P

Breeze  
Someo

### Fabric Price Group 2P

Colorama 1  
Colorama 1 Alu  
Colorama 2  
Freshtex Light  
Freshtex Linlook  
Freshtex Ultralight  
Natural  
Silente 20  
Twist

### Fabric Price Group 3P

Freshtex Dimout  
Freshtex Vision  
Linea  
Linea Alu  
Newlife 1  
Newlife 2  
Silente 10

All prices shown  
exclude VAT



# Sliding Panels

## System 2700 Panel Glide

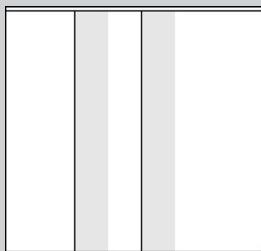

## System 2730 Panel Flex

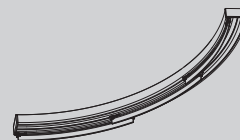

**System 2700** is delivered made to measure, ready assembled in **white**, top fix as standard. Panels either hang freely or can be connected and operated via a draw rod or cord at no extra cost.

**System 2730** is delivered made to measure, ready assembled in **white**. Panels either hang freely or can be connected and operated via a draw rod.

The systems are built up from different profiles with between 2 and 5 channels. Please consult the Silent Gliss catalogue to ensure you order the correct profile depending on how many panels and which stacking variation you require. Some technical restrictions apply.

Panels are usually between 50cm and 100cm and we recommend they overlap by approximately 10cm-15cm.

System 2700 can be electrically operated in combination with System 5600. Please consult Silent Gliss for further information.

System 2730 is only available as complete systems with fabric panels.

				Price Qty.
<b>HARDWARE PRICES</b>				<b>C</b>
System 2700 – Straight Only				
	<b>Manual</b>			
150cm	£300.20			
200cm	£377.18			
250cm	£454.14			
300cm	£531.12			
350cm	£608.10			
400cm	£685.07			
450cm	£762.05			
500cm	£839.01			
550cm	£914.52			
600cm	£987.68			
<b>PRICES PER FABRIC PANEL (max drop 3m)</b>				
	Up to 60cm wide	60cm - 130cm wide		
Price Group 1	£206.75	£266.35		
Price Group 2	£236.52	£308.97		
Price Group 3	£306.81	£422.52		
Price Group 4	£455.81	£615.94		
<b>FABRIC SUITABILITY</b>				
Price Group 1	Price Group 2	Price Group 3	Price Group 4	
Basic Screen 5%	Colorama 2	Alutex	Aluscreen Futura	
Breeze	Colorama 2 Alu	Colorama 2 Bioactive	Deep	
Colorama 1	Freshtex Linlook	Freshtex Dimout		
Colorama Alu 1	Mercuro B	Freshtex Vision		
Element	Multi Shadow	Lightscreen		
Freshtex Light	Multi Visio	Linea		
Freshtex Ultralight	Multiscreen 1%	Linea Alu		
Leviso	Multiscreen 5%	Moon		
Natural	Multiscreen 10%	Newlife Screen Alu		
Someo	Newlife Screen	Newlife 1		
Sunset	Optiscreen 4%	Newlife 2		
	Reflex	Optiscreen 4% Alu		
	Safescreen	Silente 10		
	Silente 20	Twin Blackout		
	Somnia			
	Triscreen 1%			
	Triscreen 3%			
	Triscreen 5%			
	Twist			
	Versascreen 1%			
	Versascreen 5%			
	Versascreen 10%			

Supplied with roller gliders as standard, available with optional click-in gliders at no extra cost.

Face fix brackets will carry an additional cost.

All prices shown  
exclude VAT

				Price Qty.
<b>HARDWARE PRICES</b>				<b>C</b>
System 2730 – Straight or Curved				
	<b>Manual</b>			
150cm	£327.33			
200cm	£425.58			
250cm	£523.81			
300cm	£622.06			
350cm	£720.30			
400cm	£818.53			
450cm	£916.80			
500cm	£1015.04			
550cm	£1113.27			
600cm	£1211.52			
<b>PRICES PER FABRIC PANEL (max drop 3m)</b>				
	Up to 60cm wide	60cm - 130cm wide		
Price Group 1	£206.75	£266.35		
Price Group 2	£236.52	£308.97		
Price Group 3	£306.81	£422.52		
Price Group 4	£455.81	£615.94		
<b>FABRIC SUITABILITY</b>				
Price Group 1	Price Group 2	Price Group 3		
Breeze	Colorama 2	Freshtex Dimout		
Someo	Freshtex Light	Freshtex Vision		
Colorama 1	Freshtex Linlook	Linea		
Colorama 1 Alu	Freshtex Ultralight	Newlife 1		
Leviso	Natural	Linea Alu		
	Reflex	Newlife 2		
	Silente 20	Silente 10		
	Twist			
	Somnia			
<b>BENDS</b>				
			<b>Max. trade discount</b>	
25%				
For each bend add the following to the above system price				
Gradual curve	£667.50			
Angle bend	£415.50			
<b>System 2730</b>				
10399 Design Fascia	£22.32 per metre, plus £3.64 per system		<b>A</b>	

All prices shown  
exclude VAT







# Skylight Systems

## System 8600

Electrically Operated  
tension roller blind.

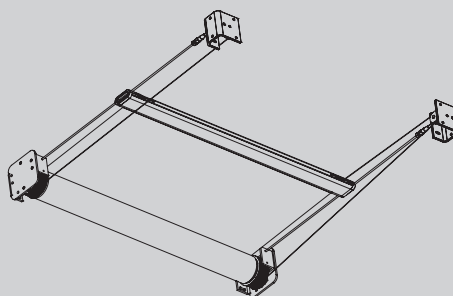

### Systems 8600

Electrically operated tensioned roller blind system.  
Max. width: 4m. Max. drop: 6.5m

#### System 8600 with Multiscreen 5% / Verascreen 5%

Price Category 'C'

Width ► Drop ▼	110cm	150cm	200cm	250cm	300cm	350cm	400cm	◀ Width ▼ Drop
100	2541.20	2566.48	2748.03	2773.68	2949.35	2980.91	3012.49	100
150	2567.94	2602.90	2796.60	2834.37	3022.23	3079.23	3109.61	150
200	2594.64	2639.31	2845.16	2895.10	3095.04	3150.93	3206.76	200
250	2621.36	2675.76	2893.73	2955.78	3167.91	3235.92	3303.92	250
300	2648.08	2712.16	2942.30	3016.51	3240.76	3320.92	3401.06	300
350	2790.83	2864.66	3101.05	3193.34	3432.61	3521.92	3614.22	350
400	2817.53	2901.09	3149.60	3254.03	3532.13	3606.93	3711.37	400
450	2844.24	2937.50	3198.17	3314.76	3575.38	3691.94	3808.50	450
500	2870.96	2973.94	3246.77	3375.48	3648.20	3776.92		500
550	2897.67	3010.36	3295.32	3436.18	3721.08	3861.92		550
600	2924.40	3046.81	3343.91	3496.91	3793.91			600
650	2951.10	3083.21	3392.48	3557.61	3866.78			650

#### System 8600 with Aluscreen Futura / Lightscreen / Safescreen

Price Category 'C'

Width ► Drop ▼	110cm	150cm	200cm	250cm	300cm	350cm	400cm	◀ Width ▼ Drop
100	2568.97	2604.33	2798.45	2837.01	3025.03	3069.49	3113.38	100
150	2606.34	2655.26	2866.43	2921.66	3126.94	3188.13	3249.31	150
200	2643.74	2706.26	2934.39	3006.64	3228.91	3307.08	3385.24	200
250	2681.11	2786.86	3002.37	3061.97	3330.84	3426.01	3521.19	250
300	2718.49	2808.21	3070.33	3176.57	3432.83	3544.82	3657.10	300
350	2871.89	2975.24	3248.48	3377.61	3650.79	3780.25	3909.08	350
400	2909.29	3026.22	3316.73	3462.56	3752.74	3898.88	4045.01	400
450	2946.68	3077.17	3384.42	3547.50	3854.71	4017.81	4180.94	450
500	2984.07	3128.13	3452.38	3632.50	3956.66	4136.78		500
550	3021.43	3179.14	3520.35	3717.45	4058.63	4255.71		550
600	3088.44	3230.10	3588.32	3802.43	4160.55			600
650	3096.20	3281.07	3656.26	3887.37	4262.50			650

Motor is fitted as standard to the left. Should you require a right hand motor there will be an additional cost of £185.19.

Profiles are standard in white (RAL 9016). Alternative colours are available at a cost of £576.46 (nett Cat E) for orders of 1-10 systems (there will be no charge for orders for 11 systems or more).

All prices shown exclude VAT



# Skylight Systems

## System 8800

Electrically Operated  
heavy duty glass roof  
shading system.

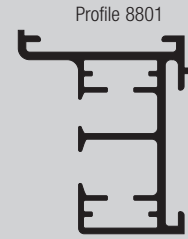
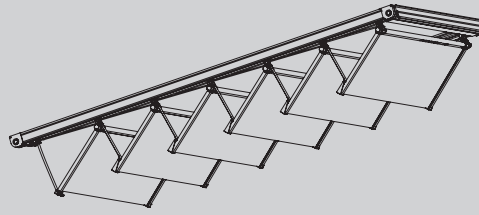

### Systems 8800

Electrically operated heavy duty glass roof shading system.  
Max. width: 3m. Max. drop: 12m. Max. m<sup>2</sup>: 36

#### System 8800 with Alutex, Safescreen or Mutiscreen 5%

Price Category 'C'

Width Drop	100cm	125mm	150cm	175mm	200cm	225mm	250cm	275mm	300cm	Width Drop
400	6097.17	6230.60	6393.04	6549.68	6712.13	6839.76	7002.19	7158.83	7321.26	400
450	6491.69	6659.92	6822.35	6984.77	7176.20	7338.66	7506.90	7669.34	7860.79	450
500	6862.95	7031.19	7228.42	7390.87	7588.11	7756.36	7953.61	8121.84	8313.29	500
550	7251.65	7454.69	7657.72	7860.79	8069.63	8272.69	8475.71	8678.76	8881.81	550
600	7611.32	7825.98	8040.62	8249.47	8493.12	8701.96	8916.62	9131.28	9369.12	600
650	8104.46	8324.90	8568.56	8818.01	9061.66	9282.09	9525.77	9769.41	10018.86	650
700	8574.32	8823.80	9073.25	9328.53	9577.95	9827.42	10082.69	10332.14	10581.60	700
750	8963.04	9224.11	9508.36	9769.41	10053.67	10308.92	10599.00	10854.26	11138.51	750
800	9328.53	9595.37	9891.23	10181.30	10477.17	10738.23	11034.09	11324.16	11620.04	800
850	9723.01	10018.86	10320.54	10616.41	10941.26	11242.95	11538.83	11840.48	12165.35	850
900	10088.47	10390.16	10720.83	11028.31	11358.99	11660.63	11997.13	12298.79	12629.46	900
950	10540.99	10883.28	11225.54	11562.01	11904.28	12240.77	12583.04	12925.32	13261.83	950
1000	10970.26	11318.34	11672.24	12043.53	12391.60	12745.48	13093.59	13464.84	13818.72	1000
1050	11364.77	11747.67	12107.34	12490.24	12873.09	13261.83	13615.68	14004.35	14387.27	1050
1100	11730.25	12124.73	12513.42	12907.93	13302.41	13696.88	14085.59	14480.09	14874.57	1100
1150	12118.94	12519.22	12942.73	13343.00	13766.53	14161.00	14590.28	14984.79	15408.28	1150
1200	12484.43	12913.74	13314.03	13743.30	14172.57	14601.90	15008.01	15437.27	15860.80	1200

Profiles are white as standard. An additional cost will apply for alternative colours.

#### Intermediate Bracket

There is an additional cost for intermediate brackets for side-by-side systems.  
The brackets are priced at £31.50 each and the table below indicates how many brackets would be needed.

System Length	No. required	Total Cost £
4.0m	7	231.50
4.5m	8	264.50
5.0m	9	298.00
5.5m	10	331.00
6.0m	10	331.00
6.5m	11	374.00
7.0m	12	397.00
7.5m	13	430.00
8.0m	14	463.50
8.5m	15	496.00
9.0m	15	496.00
9.5m	16	529.50
10.0m	17	563.00
10.5m	18	596.00
11.0m	19	629.00
11.5m	20	662.00
12.0m	20	662.00

#### Installation

An additional charge will be calculated for installation which may include access equipment and custom brackets.

All prices shown exclude VAT



# Vertical Blinds

## Vertical Waves by Eva Marmbrandt

Suitable for use on systems 2810, 2900, 2950. Not applicable for sloping systems.

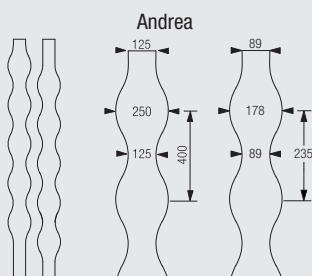

Andrea

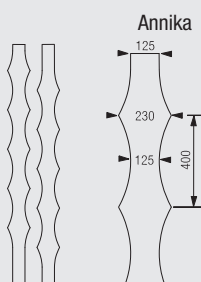

Annika

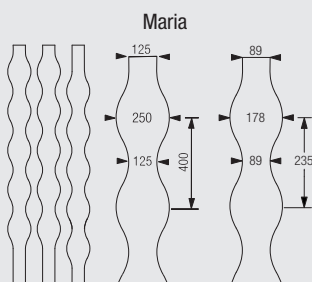

Maria

### Fabric Price Group 3 Made in Multi Visio and Multi Shadow

Minimum and maximum system length as per individual system information.  
Minimum louver drop 104cm (127mm)  
Maximum louver drop 423cm (127mm)

Minimum louver drop 110cm (89mm)  
Maximum louver drop 364cm (89mm)

Minimum distance from wall 140mm  
Can be bent to large radius >6m.

Available as 89mm (Maria and Andrea) or 127mm louvres.

## System 2810

Profile only 2601 available in 6 metre lengths.  
Cannot be bent. Headrail available in silver and white.

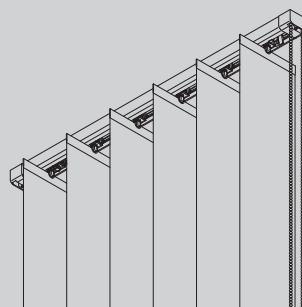

### System 2810

Track and Accessories only

Maximum system width 5m (127mm) or 3.8m (89mm).

For guidance the following number of louvres per metre should be calculated:

127mm/5"	10/metre
89mm/3 1/2"	13/metre

Track system only complete, assembled, ready to hang.

Hardware only: in silver or white, no fabrics. Excluding bottom weights and link chain but including Top clips and 2616 bracket clamps. Operating chain 150cm standard. Wall fix brackets extra. Prices given are for 127mm/5" louvres. For 89mm/3 1/2" louvres add 15%.

Width up to cm	£	Price Ctg.
60	92.45	C
80	109.58	
100	126.72	
120	143.86	
140	160.95	
160	178.07	
180	195.15	
200	212.27	
220	229.40	
240	246.53	
260	263.55	
280	280.72	
300	297.85	
320	314.93	
340	332.08	
360	349.18	
380	366.27	
400	383.39	
420	400.53	
440	417.67	
460	434.79	
480	451.95	
500	469.10	

#### Standard Accessories

- 2601 Profile only, silver or white.
- 2604 Guide.
- 2605 Top clip 127mm white.
- 2608 Endstop for 2601.
- 2610 Endstop.
- 2611 Stopper.
- 2616 Bracket.
- 2620 Pilot runner.
- 2623 Rotation element (123mm).
- 2625 Rotation element (89mm).
- 2813 Top clip 89mm white.
- 2865 Bead chain connector.
- 2872 Operating chain.
- 10400 Cord tidy

#### Optional Accessories

- 2471 Bottom weight 127mm.
- 2473 Bottom weight 89mm.
- 2479 Louvre connecting chain 89mm.
- 2481 Louvre connecting chain 127mm.
- 2606 Top clip 127mm (modified).
- 2607 Top clip 89mm (modified).
- 2614 Recess profile (suspended ceilings)
- 2615 Recess profile.
- 2618 Shaft.
- 2624 Adjustment element (101mm).
- 2824 Spacer (65mm).
- 5118 Wedge.
- 6268 Hanger.

- 3133 Bracket cover (60mm).
- 3133L Extended bracket cover (100mm).
- 3135-8 Extension bracket.

- 10482 Child safety device (metal bead chain).

Child safety device only applicable for 127mm louvres.

### Fabric price categories

For System 2810 complete with fabrics (see tables over)

#### Price Group 1

- Element
- Function

#### Price Group 2

- Alutex
- Colorama 2
- Mercurio B
- Multi Shadow
- Multi Visio
- Multiscreen 5%
- Optiscreen 4%
- Versascreen 1%
- Versascreen 5%
- Versascreen 10%

#### Price Group 3

- Colorama 2 Bioactive
- Moon
- Optiscreen 4% Alu
- Reflex
- Vertical Wave (Multi Visio, Multi shadow)

All fabrics are available in 89mm and 127mm louvres (89mm add 15%).

All above fabrics are FR.

All prices shown exclude VAT







# Vertical Blinds

## System 2950

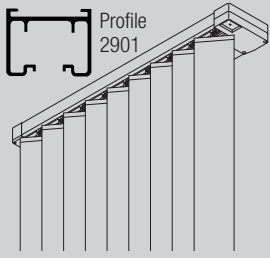

### System 2950 Electrically Operated Vertical Blind System

Track system complete,  
assembled, ready to hang.

Min. system width: 110cm  
Max. system width: 600cm  
Available in 127mm and 89mm systems.  
Supplied with plug/socket 5741/5742 and  
recess switch 0565 for open/close/tilt  
operation. Silver or white at same cost.

	Price Ctgy.
<b>Pricing for System 2950</b> Add to relevant hardware or hardware and fabric price over:	<b>C</b>
2950 £666.31	
2950R £886.21 (Integrated Receiver)	

System 0450 Radio Controls is also  
suitable for use with System 2950.

### Accessories

2901 Profile, silver or white.  
9117 Set.  
2912 Belt.  
2925 Belt connector.  
2927 Pilot runner.  
3033 Clamp.  
9091 Motor

Bends	Max. trade discount	25%
Radius cm	Profile 2901	
50-99	£125.00	
Over 99	£238.00	

**Colours**  
Other colours special order –  
see page 70.

### Pricing Examples

2950 200cm width,  
straight hardware only:  
2900 +per system  
£503.15 +£666.97  
= £1170.12

**Note:** Price based on 127mm/5" system.

All prices shown  
exclude VAT

## System 2900

Profile 2901 available in 6  
metre lengths only. Headrail  
available in silver and white.

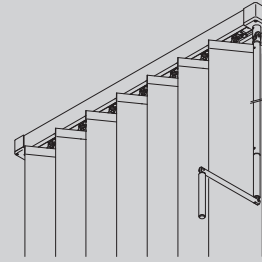

### System 2900 Track and Accessories only

Track system only complete,  
assembled, ready to hang.

Min. system width: 50cm  
Max. system width: 600cm

Width up to cm	£	Width up to cm/ft.ins.	£	Width up to cm/ft.ins.	£
120	362.92	300	678.34	480	993.75
140	397.97	320	713.39	500	1028.76
160	433.06	340	748.41	520	1063.84
180	468.10	360	783.50	540	1098.84
200	503.15	380	818.52	560	1133.95
220	538.19	400	853.57	580	1168.99
240	573.25	420	888.64	600	1204.02
260	608.31	440	923.66		
280	643.28	460	958.68		

### Accessories

2605 Top clip 127mm each, white.  
2813 Top clip 89mm each, white.  
2735 Nylon weight hook, each, 100.  
2746 Detachable crank handle  
(standard).  
2824 Endstop, each, 10.  
2471 Bottom weight 127mm.  
2473 Bottom weight 89mm.  
2479 Bottom link cord 127mm.  
2481 Bottom link cord 89mm.  
2901 Profile, per metre.  
2912 Drive belt.  
2916 Rotation element 127 mm.  
2918 Rotation element 89mm.  
2920 Endpiece set, white or grey.  
2925 Belt Connector.  
2927 Pilot runner, each  
3033 Clamps set of 10, 100.  
2849 Top clip for PVC per 100.

**Metal wall brackets with rivetted  
clamps** (fixed every 30cm plus 1  
per length in silver, white or brown).

### Adjustable type

3275/3044  
3276/3044  
3277/3044

3239 Extension bracket, each.  
2962 Connecting bridge.  
6268 Hanger bracket for recess  
profile 2948.  
6952 Magnetic handle holder.

0686 Bottom weight 89mm  
without horns.  
0687 Bottom weight 127mm  
without horns.  
1148C Screw 31mm/1 1/4" No. 8  
counter sunk, 100.

	Price Ctgy.
Hardware only, no fabric. Excluding bottom weight and link cord but including 2605 top clips and 3033 top fix clamps. Operating handle 150cm drop as standard. Wall fixing brackets extra (see below). Prices given are for 127mm/5" louvres. Sloping window+50%. For 89mm/3 1/2" louvres, add 15%. Silver or white at same cost	<b>C</b>

**Colours**  
Other colours special order –  
see page 70.

Bends	Max trade discount	25%
Radius/cm	Profile 2901	
50-99	£125.00	
Over 99	£238.00	

**N.B.**  
For guidance the following  
number of louvres per metre  
should be calculated:  
89mm : 13/metre  
127mm : 10/metre

## Fabric price categories

For system 2900 complete  
with fabrics (see tables over)

### Price Group 1

Element  
Function

### Price Group 2

Alutex  
Colorama 2  
Mercurio B  
Multi Shadow  
Multi Visio  
Multiscreen 5%  
Optiscreen 4%  
Versascreen 1%  
Versascreen 5%  
Versascreen 10%

### Price Group 3

Colorama 2 Bioactive  
Moon  
Optiscreen 4% Alu  
Reflex  
Vertical Wave

All fabrics are available in 89mm and  
127mm louvres.

All above fabrics are FR



# System 2900 complete with fabric

The prices below comprise complete system, silver or white ready-to-hang, top fix, single or pair stack with fabric choice in 127mm/5" louvres (see fabric price categories). Includes bottom weights and bottom link cord to both sides, 150cm drop operating crank handle. Wall fix brackets extra. For 89mm/3 1/2" louvres add 15%. If sizes lie between the measurements shown, the price for the next larger size will apply.

Price Category C

Width cm	UP TO 120			UP TO 140			UP TO 160		
	1	2	3	1	2	3	1	2	3
Drop cm									
60	460.65	492.83	527.74	505.72	543.28	584.00	550.76	593.66	640.21
80	472.30	515.18	561.71	519.28	569.32	623.67	566.27	623.46	685.51
100	483.90	537.62	595.72	532.89	595.43	663.31	581.76	653.33	730.86
120	495.56	559.91	629.64	546.41	621.50	702.92	597.27	683.14	776.17
140	507.14	582.30	663.72	559.95	647.60	742.57	612.77	712.94	821.47
160	518.79	604.64	697.67	573.53	673.71	782.21	628.29	742.73	866.73
180	530.43	627.01	731.65	587.14	699.78	821.92	643.80	772.56	912.09
200	542.06	649.38	765.67	600.67	725.90	861.53	659.28	802.35	957.38
220	553.72	671.67	799.62	614.28	751.97	901.16	674.82	832.21	1002.72
240	565.33	694.04	833.64	627.78	778.01	940.84	690.33	862.01	1048.06
260	576.90	716.47	867.59	641.35	804.12	980.49	705.82	891.82	1093.38
280	588.57	738.81	901.62	654.93	830.18	1020.12	721.31	921.63	1138.70
300	600.22	761.19	935.60	668.49	856.30	1059.80	736.77	951.42	1183.96
320	611.85	783.51	969.57	682.08	882.40	1099.43	752.31	981.21	1229.32
340	623.44	805.88	1003.58	695.66	908.44	1139.09	767.84	1011.10	1274.63
360	635.07	828.24	1037.55	709.21	934.58	1178.74	783.32	1040.89	1319.93
380	646.73	850.57	1071.54	722.78	960.60	1218.41	798.85	1070.70	1365.29
400	658.36	872.94	1105.51	736.34	986.73	1258.09	814.36	1100.48	1410.56

Width cm	UP TO 180			UP TO 200			UP TO 220		
	1	2	3	1	2	3	1	2	3
Drop cm									
60	595.82	644.11	696.41	640.90	694.50	752.66	685.90	744.94	808.88
80	613.23	677.65	747.38	660.25	731.78	809.37	707.25	785.96	871.17
100	630.66	711.19	798.39	679.59	769.03	865.91	728.54	826.92	933.51
120	648.15	744.68	849.36	699.00	806.31	922.60	749.88	867.89	995.84
140	665.58	778.26	900.36	718.39	843.55	979.25	771.19	908.92	1058.14
160	683.01	811.78	951.33	737.78	880.86	1035.90	792.48	949.88	1120.41
180	700.46	845.34	1002.33	757.16	918.12	1092.53	813.83	990.91	1182.72
200	717.92	878.87	1053.29	776.56	955.35	1149.19	835.12	1031.87	1245.06
220	735.38	912.40	1104.26	795.93	992.66	1205.84	856.46	1072.87	1307.36
240	752.80	945.96	1155.28	815.30	1029.89	1262.48	877.78	1113.85	1369.66
260	770.25	979.47	1206.22	834.68	1067.20	1319.09	899.14	1154.84	1432.01
280	787.65	1013.01	1257.24	854.05	1104.43	1375.76	920.44	1195.83	1494.28
300	805.15	1046.56	1308.22	873.42	1141.69	1432.39	941.73	1236.80	1556.64
320	822.58	1080.12	1359.19	892.82	1178.98	1489.05	963.08	1277.78	1618.95
340	840.01	1113.66	1410.14	912.18	1216.23	1545.68	984.39	1318.80	1681.24
360	857.46	1147.21	1461.14	931.59	1253.49	1602.34	1005.71	1359.80	1743.53
380	874.92	1180.71	1512.12	950.99	1290.74	1658.98	1027.03	1400.75	1805.84
400	892.29	1214.24	1563.12	970.35	1328.01	1715.63	1048.31	1441.77	1868.17

Width cm	UP TO 240			UP TO 260			UP TO 280		
	1	2	3	1	2	3	1	2	3
Drop cm									
60	730.97	795.36	865.15	776.02	845.75	921.33	821.08	896.18	977.58
80	754.22	840.03	933.12	801.20	894.19	994.97	848.17	948.31	1056.86
100	777.49	884.77	1001.05	826.40	942.63	1068.63	875.33	1000.52	1136.19
120	800.75	929.50	1069.02	851.59	991.07	1142.28	902.48	1052.70	1215.50
140	823.94	974.21	1137.02	876.80	1039.55	1215.91	929.61	1104.86	1294.80
160	847.25	1018.90	1205.00	901.97	1088.00	1289.57	956.72	1157.03	1374.09
180	870.51	1063.67	1272.96	927.19	1136.43	1363.16	983.84	1209.21	1453.42
200	893.76	1108.38	1340.99	952.38	1184.84	1436.82	1011.00	1261.39	1532.69
220	917.03	1153.08	1408.88	977.58	1233.31	1510.51	1038.18	1313.51	1612.03
240	940.23	1197.76	1476.86	1002.75	1281.76	1584.08	1065.29	1365.70	1691.30
260	963.52	1242.54	1544.87	1027.96	1330.21	1657.79	1092.41	1417.90	1770.63
280	986.80	1287.23	1612.81	1053.17	1378.65	1731.38	1119.52	1470.00	1849.94
300	1010.04	1332.00	1680.83	1078.34	1427.09	1805.00	1146.65	1522.23	1929.21
320	1033.33	1376.67	1748.80	1103.54	1475.51	1878.66	1173.82	1574.40	2008.56
340	1056.53	1421.40	1816.76	1128.76	1524.00	1952.28	1200.96	1626.59	2087.79
360	1079.83	1466.12	1884.71	1153.96	1572.45	2025.93	1228.08	1678.72	2167.14
380	1103.06	1510.87	1952.67	1179.10	1620.89	2099.55	1255.20	1730.89	2246.43
400	1126.30	1555.55	2020.68	1204.33	1669.30	2173.17	1282.31	1783.07	2325.73

All prices shown exclude VAT



# System 2900 complete with fabric

The prices below comprise complete system, silver or white ready-to-hang, top fix, single or pair stack with fabric choice in 127mm/5" louvres (see fabric price categories). Includes bottom weights and bottom link cord to both sides, 150cm drop operating crank handle. Wall fix brackets extra. For 89mm/3 1/2" louvres add 15%. If sizes lie between the measurements shown, the price for the next larger size will apply.

Price Category C

Width	UP TO 300			UP TO 320			UP TO 340		
	1	2	3	1	2	3	1	2	3
Drop cm									
60	866.13	946.59	1033.78	911.16	996.98	1090.05	956.24	1047.41	1146.27
80	895.16	1002.52	1118.78	942.18	1056.62	1180.65	989.17	1110.73	1242.59
100	924.25	1058.41	1203.74	973.17	1116.26	1271.32	1022.13	1174.13	1338.87
120	953.30	1114.29	1288.68	1004.21	1175.86	1361.94	1055.07	1237.44	1435.16
140	982.37	1170.21	1373.72	1035.21	1235.48	1452.59	1088.01	1300.86	1531.43
160	1011.48	1226.09	1458.65	1066.20	1295.10	1543.16	1120.95	1364.18	1627.72
180	1040.54	1281.97	1543.64	1097.24	1354.76	1633.81	1153.89	1427.53	1724.05
200	1069.60	1337.87	1628.57	1128.27	1414.35	1724.47	1186.85	1490.90	1820.33
220	1098.67	1393.77	1713.53	1159.25	1474.00	1815.10	1219.81	1554.21	1916.66
240	1127.76	1449.63	1798.55	1190.26	1533.62	1905.74	1252.74	1617.56	2012.94
260	1156.82	1505.53	1883.49	1221.22	1593.23	1996.35	1285.69	1680.92	2109.26
280	1185.91	1561.48	1968.48	1252.27	1652.88	2086.99	1318.65	1744.25	2205.56
300	1214.97	1617.36	2053.44	1283.28	1712.51	2177.65	1351.61	1807.66	2301.83
320	1244.07	1673.25	2138.37	1314.31	1772.13	2268.23	1384.53	1870.96	2398.13
340	1273.10	1729.16	2223.35	1345.31	1831.73	2358.88	1417.44	1934.30	2494.41
360	1302.21	1785.03	2308.33	1376.29	1891.38	2449.51	1450.43	1997.69	2590.71
380	1331.24	1840.94	2393.29	1407.32	1950.98	2540.18	1483.37	2061.02	2687.00
400	1360.35	1896.83	2478.24	1438.33	2010.66	2630.83	1516.33	2124.37	2783.31

Width	UP TO 360			UP TO 380			UP TO 400		
	1	2	3	1	2	3	1	2	3
Drop cm									
60	1001.26	1097.82	1202.48	1046.34	1148.26	1258.74	1091.34	1198.66	1314.98
80	1036.15	1164.93	1304.46	1083.16	1219.05	1366.32	1130.12	1273.19	1428.25
100	1071.04	1232.01	1406.40	1119.98	1289.86	1473.99	1168.85	1347.74	1541.54
120	1105.90	1299.07	1508.41	1156.80	1360.65	1581.60	1207.64	1422.25	1654.82
140	1140.84	1366.16	1610.36	1193.64	1431.47	1689.20	1246.42	1496.75	1768.10
160	1175.69	1433.24	1712.29	1230.43	1502.25	1796.82	1285.20	1571.33	1881.42
180	1210.56	1500.28	1814.26	1267.25	1573.08	1904.49	1323.92	1645.83	1994.70
200	1245.42	1567.37	1916.21	1304.08	1643.87	2012.09	1362.71	1720.37	2108.00
220	1280.38	1634.43	2018.18	1340.92	1714.70	2119.75	1401.45	1794.91	2221.29
240	1315.22	1701.57	2120.18	1377.72	1785.48	2227.32	1440.22	1869.43	2334.55
260	1350.12	1768.60	2222.13	1414.58	1856.27	2335.01	1478.99	1943.96	2447.87
280	1385.00	1835.66	2324.06	1451.36	1927.09	2442.66	1517.76	2018.46	2561.14
300	1419.89	1902.74	2426.05	1488.21	1997.88	2550.23	1556.51	2093.01	2674.39
320	1454.78	1969.85	2528.03	1525.01	2068.67	2657.91	1595.28	2167.57	2787.75
340	1489.68	2036.94	2629.96	1561.86	2139.49	2765.49	1634.03	2242.09	2901.01
360	1524.53	2103.98	2731.94	1598.68	2210.31	2873.10	1672.80	2316.58	3014.33
380	1559.43	2171.06	2833.86	1635.46	2281.07	2980.72	1711.53	2391.10	3127.64
400	1594.33	2238.13	2935.85	1672.32	2351.91	3088.37	1750.30	2465.64	3240.94

Width	UP TO 420			UP TO 440			UP TO 460		
	1	2	3	1	2	3	1	2	3
Drop cm									
60	1136.42	1249.07	1371.18	1181.51	1299.51	1427.39	1226.51	1349.88	1483.64
80	1177.10	1327.34	1490.15	1224.11	1381.46	1552.05	1271.11	1435.67	1613.89
100	1217.81	1405.57	1609.10	1266.75	1463.45	1676.69	1315.63	1521.36	1744.21
120	1258.52	1483.88	1728.08	1309.42	1545.41	1801.28	1360.22	1607.06	1874.51
140	1299.21	1562.10	1847.02	1352.02	1627.43	1925.93	1404.85	1692.75	2004.77
160	1339.92	1640.33	1965.96	1394.67	1709.41	2050.52	1449.41	1778.45	2135.09
180	1380.62	1718.62	2084.90	1437.28	1791.39	2175.17	1493.99	1864.18	2265.35
200	1421.31	1796.83	2203.86	1479.94	1873.39	2299.75	1538.55	1949.88	2395.64
220	1462.04	1875.15	2322.83	1522.62	1955.35	2424.39	1583.12	2035.62	2525.93
240	1502.71	1953.36	2441.79	1565.20	2037.33	2548.99	1627.70	2121.25	2656.22
260	1543.43	2031.67	2560.70	1607.87	2119.31	2673.60	1672.28	2207.01	2786.49
280	1584.10	2109.90	2679.68	1650.47	2201.29	2798.25	1716.86	2292.71	2916.76
300	1624.81	2188.17	2798.67	1693.13	2283.28	2922.89	1761.46	2378.43	3047.04
320	1665.52	2266.41	2917.59	1735.77	2365.24	3047.47	1805.99	2464.15	3177.36
340	1706.19	2344.66	3036.59	1778.37	2447.21	3172.07	1850.60	2549.85	3307.64
360	1746.87	2422.88	3155.51	1821.03	2529.24	3296.72	1895.13	2635.51	3437.93
380	1787.63	2501.16	3274.50	1863.68	2611.21	3421.36	1939.71	2721.29	3568.20
400	1828.32	2579.45	3393.46	1906.30	2693.21	3545.97	1984.31	2806.93	3698.51

All prices shown exclude VAT





# System 2900 complete with fabric

The prices below comprise complete system, silver or white ready-to-hang, top fix, single or pair stack with fabric choice in 127mm/5" louvres (see fabric price categories). Includes bottom weights and bottom link cord to both sides, 150cm drop operating crank handle. Wall fix brackets extra. For 89mm/3 1/2" louvres add 15%. If sizes lie between the measurements shown, the price for the next larger size will apply.

Price Category C

Width cm	UP TO 480			UP TO 500			UP TO 520		
Drop cm	1	2	3	1	2	3	1	2	3
60	1271.59	1400.37	1539.91	1316.57	1450.74	1596.13	1361.63	1501.15	1652.28
80	1318.10	1489.75	1675.84	1365.05	1543.86	1737.70	1412.09	1598.07	1799.61
100	1364.61	1579.22	1811.73	1413.49	1637.08	1879.32	1462.43	1694.93	1946.89
120	1411.10	1668.65	1947.74	1462.00	1730.21	2020.95	1512.85	1791.81	2094.19
140	1457.63	1758.08	2083.66	1510.43	1823.40	2162.58	1563.23	1888.74	2241.48
160	1504.16	1847.52	2219.60	1558.86	1916.58	2304.15	1613.62	1985.58	2388.76
180	1550.63	1936.94	2355.58	1607.32	2009.73	2445.77	1664.01	2082.50	2536.01
200	1597.17	2026.32	2491.50	1655.75	2102.90	2587.37	1714.39	2179.38	2683.30
220	1643.68	2115.81	2627.48	1704.28	2196.03	2729.01	1764.79	2276.27	2830.54
240	1690.19	2205.25	2763.42	1752.71	2289.24	2870.62	1815.18	2373.16	2977.83
260	1736.73	2294.68	2899.38	1801.13	2382.33	3012.23	1865.56	2470.06	3125.10
280	1783.19	2384.11	3035.32	1849.58	2475.51	3153.83	1915.99	2566.96	3272.37
300	1829.74	2473.55	3171.26	1898.04	2568.69	3295.46	1966.36	2663.82	3419.64
320	1876.28	2563.00	3307.24	1946.51	2661.83	3437.13	2016.75	2760.70	3566.98
340	1922.77	2652.42	3443.14	1994.96	2754.99	3578.69	2067.15	2857.61	3714.21
360	1969.30	2741.89	3579.15	2043.41	2848.20	3720.31	2117.54	2954.50	3861.48
380	2015.80	2831.28	3715.09	2091.84	2941.32	3861.90	2167.94	3051.38	4008.75
400	2062.29	2920.71	3851.02	2140.28	3034.53	4003.57	2218.30	3148.27	4156.08

Width cm	UP TO 540			UP TO 560			UP TO 580		
Drop cm	1	2	3	1	2	3	1	2	3
60	1406.71	1551.59	1708.57	1451.74	1601.97	1764.79	1496.83	1652.42	1821.00
80	1459.04	1652.20	1861.53	1506.04	1706.36	1923.39	1552.98	1760.48	1985.32
100	1511.38	1752.82	2014.46	1560.31	1810.69	2081.99	1609.25	1868.50	2149.53
120	1563.73	1853.39	2167.38	1614.55	1914.98	2240.60	1665.44	1976.65	2313.85
140	1616.01	1954.02	2320.32	1668.85	2019.36	2399.24	1721.65	2084.66	2478.09
160	1668.36	2054.66	2473.29	1723.11	2123.70	2557.83	1777.86	2192.73	2642.37
180	1720.68	2155.25	2626.24	1777.36	2228.06	2716.43	1833.99	2300.83	2806.68
200	1773.05	2255.89	2779.17	1831.62	2332.35	2875.02	1890.24	2408.87	2970.87
220	1825.33	2356.52	2932.08	1885.91	2436.70	3033.70	1946.48	2516.97	3135.21
240	1877.67	2457.11	3085.05	1940.16	2541.08	3192.25	2002.68	2625.03	3299.43
260	1930.01	2557.73	3237.96	1994.44	2645.40	3350.87	2058.88	2733.10	3463.76
280	1982.34	2658.33	3390.94	2048.73	2749.78	3509.46	2115.06	2841.15	3628.05
300	2034.65	2758.96	3543.92	2102.95	2854.02	3668.12	2171.25	2949.24	3792.29
320	2086.99	2859.55	3696.80	2157.28	2958.46	3826.68	2227.49	3057.26	3956.61
340	2139.30	2960.17	3849.77	2211.49	3062.75	3985.30	2283.70	3165.34	4120.84
360	2191.65	3060.80	4002.69	2265.78	3167.10	4143.90	2339.90	3273.43	4285.11
380	2243.93	3161.41	4155.66	2320.01	3271.44	4302.53	2396.10	3381.47	4449.38
400	2296.28	3262.06	4308.61	2374.29	3375.78	4461.10	2452.26	3489.54	4613.68

Width cm	UP TO 600		
Drop cm	1	2	3
60	1541.84	1702.83	1877.22
80	1599.98	1814.61	2047.17
100	1658.16	1926.45	2217.15
120	1716.27	2038.19	2387.09
140	1774.44	2150.01	2557.02
160	1832.61	2261.82	2726.93
180	1890.78	2373.62	2896.83
200	1948.92	2485.39	3066.82
220	2007.04	2597.16	3236.76
240	2065.18	2708.98	3406.69
260	2123.33	2820.77	3576.60
280	2181.47	2932.56	3746.59
300	2239.58	3044.37	3916.49
320	2297.75	3156.13	4086.40
340	2355.89	3267.93	4256.39
360	2414.01	3379.76	4426.31
380	2472.12	3491.54	4596.24
400	2530.28	3603.34	4766.16

All prices shown exclude VAT



# Roller Blinds

## System 4900

Spring operation with decelerator.  
Tube diameter 32.2mm

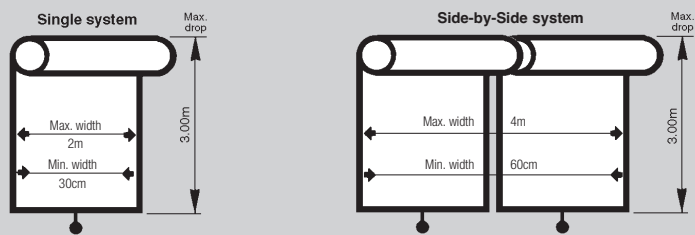

### System 4900 complete with fabric

The prices below comprise the complete system made-to-measure, ready-to-hang with fabric of your choice. Operation as standard with pull-ball. Please consult application chart (page 52 of our main price list) to ensure that fabric chosen can be supplied in dimensions required.

Price category C

#### Price Group 1R

Basic Screen 5%  
Colorama 1  
Colorama 1 Alu  
Element  
Puma

Width	60cm	80cm	100cm	120cm	140cm	160cm	180cm	200cm	Width
Drop									Drop
60	224.39	237.28	250.18	263.11	275.97	288.94	301.79	314.70	60
80	228.85	243.22	257.62	271.94	286.35	300.74	315.14	329.47	80
100	233.26	249.14	264.99	280.89	296.69	312.56	328.44	344.33	100
120	237.70	255.05	272.38	289.76	307.04	324.45	341.76	359.12	120
140	242.13	260.95	279.78	298.62	317.40	336.25	355.06	373.91	140
160	246.56	266.87	287.16	307.50	327.79	348.08	368.41	388.71	160
180	250.99	272.82	294.61	316.37	338.16	359.95	381.75	403.44	180
200	255.53	278.69	301.98	325.26	348.46	371.79	395.02	418.30	200
220	259.91	284.68	309.41	334.09	358.84	383.60	408.36	433.08	220
240	264.35	290.59	316.77	343.02	369.22	395.46	421.68	447.88	240
260	268.76	296.50	324.19	351.88	379.62	407.27	435.03	462.76	260
280	273.23	302.39	331.57	360.71	389.99	419.12	448.30	477.47	280
300	277.65	308.35	338.95	369.61	400.32	430.96	461.63	492.28	300

#### Price Group 2R

Alutex  
Colorama 2  
Colorama 2 Alu  
Colorama 2 Bioactive  
Mercurio B  
Multi Shadow  
Multi Visio  
Multiscreen 5%  
Multiscreen 10%  
Newlife Screen  
Optiscreen  
Silente 20  
Versascreen 5%  
Versascreen 10%

Width	60cm	80cm	100cm	120cm	140cm	160cm	180cm	200cm	Width
Drop									Drop
60	232.86	248.56	264.25	279.99	295.73	311.42	327.15	342.85	60
80	240.07	258.23	276.36	294.51	312.64	330.74	348.89	367.04	80
100	247.36	267.89	288.47	308.98	329.51	350.10	370.66	391.21	100
120	254.59	277.58	300.55	323.56	346.51	369.44	392.42	415.40	120
140	261.86	287.24	312.64	338.02	363.43	388.83	414.20	439.56	140
160	269.13	296.93	324.69	352.54	380.36	408.16	435.93	463.75	160
180	276.36	306.54	336.78	367.04	397.31	427.52	457.71	487.94	180
200	283.61	316.24	348.89	381.53	414.20	446.82	479.47	512.15	200
220	290.86	325.90	360.96	396.05	431.12	466.17	501.22	536.32	220
240	298.14	335.56	373.12	410.55	448.06	485.51	523.02	560.52	240
260	305.40	345.29	385.17	425.07	464.96	504.85	544.75	584.63	260
280	312.64	354.96	397.31	439.56	481.86	524.21	566.51	608.83	280
300	319.90	364.60	409.36	454.09	498.82	543.53	588.28	633.03	300

#### Price Group 3R

Aluscreen Futura  
Deep  
Ecoscreen  
Lightscreen  
Linea  
Linea Alu  
Moon  
Newlife 1  
Newlife 2  
Newlife Screen Alu  
Optiscreen Alu  
Reflex  
Safescreen  
Silente 10

Width	60cm	80cm	100cm	120cm	140cm	160cm	180cm	200cm	Width
Drop									Drop
60	251.09	272.94	294.68	316.49	338.30	360.14	381.89	403.75	60
80	264.44	290.68	316.93	343.21	369.48	395.70	422.00	448.20	80
100	277.76	308.50	339.22	369.92	400.59	431.28	462.02	492.69	100
120	291.15	326.28	361.42	396.59	431.71	466.86	502.06	537.17	120
140	304.49	344.04	383.66	423.28	462.87	502.49	542.04	581.64	140
160	317.79	361.85	405.95	449.93	493.97	538.02	582.11	626.13	160
180	331.14	379.65	428.16	476.62	525.13	573.63	622.08	670.61	180
200	344.51	397.43	450.37	503.33	556.26	609.18	662.12	715.10	200
220	357.82	415.23	472.65	530.01	587.36	644.78	702.18	759.54	220
240	371.21	433.02	494.89	556.68	618.49	680.33	742.18	804.05	240
260	384.50	450.79	517.06	583.38	649.65	715.96	782.21	848.48	260
280	397.87	468.60	539.32	610.08	680.76	751.52	822.27	892.97	280
300	411.18	486.39	561.59	636.74	711.92	787.14	862.29	937.45	300

### System 4900 – Hardware only

Supplied ready-assembled incl. adhesive tape for customers to mount own fabrics. Bottom bar not incl. – see page 52 of our main price list.

Side-guide wire option is available at an additional cost of £44.50.

For optional stop controller add £16.00.

Spring	Width of blind up to							Price category C	
Clutch	60cm	80cm	100cm	120cm	140cm	160cm	180cm	200cm	
4212/3 A/B	181.37	184.68	188.02	191.37	194.69	198.03	201.36	204.68	
4214/5 C/D	209.91	213.39	216.86	220.33	223.76	230.69	234.17	237.59	
4216/7 E/F	215.85	219.26	222.71	226.16	229.54	232.98	236.42	239.87	

Consult Silent Gliss to determine spring type required.

### Continuous Headrail

Provides an alternative to fitting to the wall or ceiling, supplied made to measure in silver or white (other custom colours available, pricing as per page 70 of our main price list), for use on 4900, 4910 and 4960. £25.87 per m add on.

### System 4900 – Side-by-Side System

Simply price as two separate systems stating side-by-side.



# Roller Blinds

## Laminated Blinds (Customer's own material for Roller Blinds)

Supply your own fabric, we will provide the laminating service. Prices below include for hardware systems 4900/4910. Sewn-in bottom bar supplied as standard (Trim 16). For decorative trims choose from table below. All blinds supplied forward roll as standard; please specify if reverse roll is required. Our laminate will usually be supplied in cream as standard.

Please send a flat sample of customer's own material (1m<sup>2</sup> minimum) so that Silent Gliss can confirm suitability for laminating. All fabrics must be approved prior to ordering.

Price category C

Width cm	System	100	120	140	160	170	180	200	220	230
Drop cm										
90		334.54	360.88	387.32	413.64	439.98	708.20	719.41	774.44	788.08
120		371.90	405.70	439.65	473.48	507.25	738.88	765.66	810.95	851.37
150	4900/	409.31	450.56	492.06	533.28	574.54	810.44	853.30	896.15	999.87
180	4910/	446.68	495.41	544.39	593.09	641.82	859.13	960.41	1003.26	1094.80
210	(4960 electric)	484.02	540.28	596.71	652.93	709.13	963.80			
240		521.34	584.98	648.89	712.54	776.20	1017.36			
270		649.21	721.51	794.15	866.45	938.70	1126.90			
300		686.57	766.36	848.32	929.82	1013.67				

Prices in this table are for spring or chain operation. For electric (4960) add £514.38.

### Flame Retardant (FR) Laminate

Add 20% to prices shown above. FR laminate available in white or cream.

### Blackout Laminate

Add 20% to prices shown above. Blackout laminate available in white or cream.

### Decorative Trims

All shapes come with matching braid unless otherwise specified. Add price for trim to prices above.

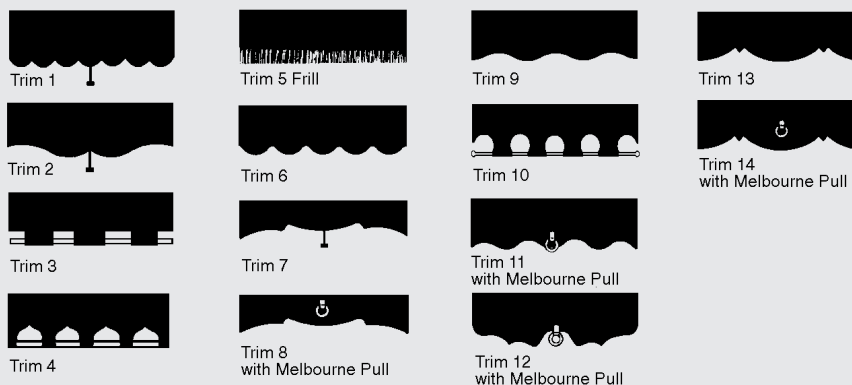

### Alternative Trims

Price category C

Width cm	80	100	120	140	160	170
Trims 1, 2, 5, 6, 7, 9 & 13	£32.85	35.31	49.27	57.42	65.61	69.73
Trims 3, 4 & 10	£48.21	60.32	72.39	84.42	96.50	102.54
Trims 8, 11, 12, 14	£71.15	88.92	106.65	124.40	142.14	151.01

### Piping

Piping for Trims 1, 2, 5, 6: add 20% to prices above and send fabric for piping.

All prices shown exclude VAT



# Roller Blinds

## System 4907

Chain operated roller blinds.  
Tube diameter 32.2mm

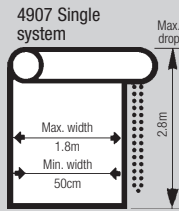

### System 4907 complete with fabric

The prices below comprise the complete system made-to-measure, ready-to-hang with fabric of your choice. Please consult application chart (page 52) to ensure that fabric desired can be supplied in dimensions required.

Price category C

#### Price Group 1R

Colorama 1  
Colorama 1 Alu  
Element  
**Puma**  
**Basic Screen 5%**

Width	60cm	80cm	100cm	120cm	140cm	160cm	180cm	Width
Drop cm								Drop cm
60	201.95	213.55	225.16	236.81	248.38	260.04	271.61	60
80	205.96	218.89	231.86	244.76	257.71	270.66	283.63	80
100	209.94	224.23	238.48	252.80	267.03	281.32	295.61	100
120	213.93	229.54	245.14	260.78	276.34	292.01	307.58	120
140	217.92	234.86	251.81	268.75	285.67	302.63	319.55	140
160	221.90	240.18	258.45	276.76	295.02	313.27	331.56	160
180	225.90	245.53	265.15	284.72	304.35	323.96	343.58	180
200	229.97	250.82	271.79	292.73	313.62	334.60	355.52	200
220	233.91	256.21	278.47	300.68	322.95	345.24	367.52	220
240	237.92	261.53	285.10	308.73	332.29	355.92	379.51	240
260	241.89	266.85	291.76	316.70	341.66	366.54	391.51	260
280	245.90	272.16	298.41	324.64	350.98	377.20	403.46	280

#### Price Group 2R

Alutex  
Colorama 2  
Colorama 2 Alu  
Colorama 2 Bioactive  
Mercurio B  
Multi Shadow  
Multi Visio  
**Multiscreen 1%**  
**Multiscreen 5%**  
**Multiscreen 10%**  
Newlife Screen  
Optiscreen  
Silente 20

**Triscreen 1%**  
**Triscreen 3%**  
**Triscreen 5%**  
**Versascreen 1%**  
**Versascreen 5%**  
**Versascreen 10%**

Width	60cm	80cm	100cm	120cm	140cm	160cm	180cm	Width
Drop cm								Drop cm
60	209.57	223.71	237.83	251.99	266.15	280.28	294.43	60
80	216.07	232.41	248.73	265.07	281.38	297.66	314.00	80
100	222.62	241.10	259.61	278.08	296.56	315.09	333.60	100
120	229.13	249.82	270.50	291.20	311.86	332.50	353.17	120
140	235.67	258.52	281.38	304.22	327.09	349.94	372.78	140
160	242.21	267.24	292.23	317.28	342.32	367.33	392.32	160
180	248.73	275.88	303.10	330.33	357.58	384.77	411.95	180
200	255.23	284.60	314.00	343.38	372.78	402.13	431.52	200
220	261.77	293.31	324.87	356.44	388.01	419.56	451.10	220
240	268.32	302.01	335.80	369.48	403.25	436.96	470.72	240
260	274.88	310.76	346.66	382.58	418.46	454.37	490.28	260
280	281.38	319.46	357.58	395.61	433.67	471.79	509.85	280

#### Price Group 3R

Aluscreen Futura  
Deep  
Ecoscreen  
Jumbotex  
Lightscreen  
Linea  
Linea Alu  
Moon  
Newlife 1  
Newlife 2  
Newlife Screen Alu

Optiscreen Alu  
Reflex  
Safescreen  
Silente 10  
Twin Blackout

Width	60cm	80cm	100cm	120cm	140cm	160cm	180cm	Width
Drop cm								Drop cm
60	225.98	245.65	265.21	284.85	304.46	324.12	343.70	60
80	238.00	261.62	285.24	308.90	332.55	356.13	379.81	80
100	249.99	277.65	305.30	332.93	360.52	388.16	415.82	100
120	262.05	293.64	325.28	356.93	388.55	420.18	451.86	120
140	274.05	309.63	345.30	380.95	416.59	452.25	487.84	140
160	286.01	325.66	365.36	404.94	444.59	484.22	523.90	160
180	298.02	341.69	385.34	428.96	472.62	516.26	559.88	180
200	310.05	357.68	405.34	452.99	500.64	548.26	595.90	200
220	322.04	373.71	425.39	477.02	528.63	580.30	631.96	220
240	334.09	389.72	445.39	501.01	556.64	612.30	667.97	240
260	346.06	405.70	465.36	525.05	584.68	644.36	703.97	260
280	358.07	421.74	485.39	549.07	612.68	676.37	740.04	280

#### System 4907 – Side-by-Side System

There is no add-on. Simply order two systems, stating side-by-side.

#### System 4907 – Hardware only

Supplied ready-assembled incl. adhesive tape for customers to mount own fabrics.

Width of blind up to

60cm	80cm	100cm	120cm	140cm	160cm	180cm
188.91	192.05	195.16	198.30	201.38	207.62	210.76

All prices shown exclude VAT





# Roller Blinds

## System 4830

Heavy duty chain operated (crank optional)  
Roller Blind system.  
Tube diameter 55mm.  
Max. surface area 10m<sup>2</sup>

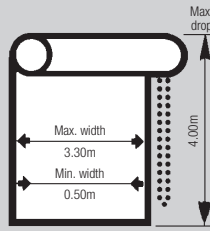

### System 4830 complete with fabric

The prices below comprise the complete system made-to-measure, ready to hang with fabric of your choice. Please be aware that due to the size capabilities of this system, larger sizes can only be achieved by welding the fabric. Fabrics that can be welded are indicated below in bold print. Please consult application chart (page 52) to ensure that fabric desired can be supplied in dimensions required.

Price Category C

#### Price Group 1R

Colorama 1  
Colorama 1 Alu  
Element  
**Puma**  
Basic Screen 5%

Width ► Drop ▼	100cm	125cm	150cm	175cm	200cm	225cm	250cm	275cm	300cm	330cm	◀ Width ▼ Drop
50cm	307.11	334.70	362.07	390.40	417.01	453.02	472.82	499.43	526.93	559.88	50cm
100cm	325.28	357.72	389.80	421.92	454.01	486.14	518.22	550.27	582.39	620.92	100cm
150cm	344.13	380.85	417.55	454.25	491.01	527.72	564.44	601.16	637.86	681.94	150cm
200cm	362.62	403.95	445.28	486.62	527.97	569.30	610.67	652.01	693.36	742.97	200cm
250cm	381.10	427.07	473.05	519.00	564.97	610.94	656.90	702.88	748.84	804.00	250cm
300cm	399.61	450.19	500.80	551.38	601.92	652.54	703.12	753.73	804.33	865.02	300cm
350cm	418.10	473.30	528.53	583.74	638.93	694.16	749.39	804.57	859.81		350cm
400cm	436.60	496.44	556.26	616.09	675.92	735.77	795.65	855.46	Max. 10m <sup>2</sup>		400cm

#### Price Group 2R

Alutex  
Colorama 2  
Colorama 2 Alu  
Colorama 2 Bioactive  
Mercurio B  
Multi Shadow  
Multi Visio  
**Multiscreen 1%**  
**Multiscreen 5%**  
**Multiscreen 10%**

Newlife Screen  
Optiscreen  
Silente 20  
**Triscreen 1%**  
**Triscreen 3%**  
**Triscreen 5%**  
**Versascreen 1%**  
**Versascreen 5%**  
**Versascreen 10%**

Width ► Drop ▼	100cm	125cm	150cm	175cm	200cm	225cm	250cm	275cm	300cm	330cm	◀ Width ▼ Drop
50cm	330.65	363.96	397.36	430.73	468.49	497.40	530.75	564.09	597.43	637.48	50cm
100cm	360.89	401.80	442.70	483.61	524.53	565.45	606.36	647.28	688.20	737.28	100cm
150cm	391.14	439.61	488.08	536.52	585.03	633.49	681.99	730.45	778.94	837.11	150cm
200cm	421.39	477.42	533.45	589.47	645.54	701.55	757.61	813.63	869.67	936.90	200cm
250cm	451.62	515.22	578.84	642.43	706.01	769.62	833.21	896.81	960.42	1040.10	250cm
300cm	481.86	553.06	624.21	695.38	766.55	837.67	908.86	980.05	1051.14	1136.57	300cm
350cm	512.15	590.85	669.54	748.29	827.02	905.74	984.47	1063.18	1141.93		350cm
400cm	542.37	628.68	714.95	801.21	887.51	973.80	1060.07	1146.38	Max. 10m <sup>2</sup>		400cm

#### Price Group 3R

Aluscreen Futura  
Deep  
Ecoscreen  
Jumbotex  
Lightscreen  
Linea  
Linea Alu  
Moon  
Newlife 1  
Newlife 2

Newlife Screen Alu  
Optiscreen Alu  
Reflex  
Safescreen  
Silente 10  
Twin Blackout

Width ► Drop ▼	100cm	125cm	150cm	175cm	200cm	225cm	250cm	275cm	300cm	330cm	◀ Width ▼ Drop
50cm	381.39	427.44	473.46	519.51	565.55	611.60	657.62	703.69	749.72	804.94	50cm
100cm	436.99	496.97	556.91	616.86	676.80	736.74	796.68	856.63	916.58	988.52	100cm
150cm	492.64	566.50	640.33	714.20	788.06	861.92	935.77	1009.59	1083.44	1172.07	150cm
200cm	548.28	636.01	723.75	811.53	899.28	987.06	1074.82	1162.59	1250.34	1355.61	200cm
250cm	603.90	705.56	807.22	908.88	1010.55	1112.22	1213.86	1315.52	1417.20	1539.20	250cm
300cm	659.49	775.08	890.66	1006.24	1121.81	1237.37	1352.94	1468.50	1584.07	1722.77	300cm
350cm	715.16	844.62	974.10	1103.56	1233.04	1362.50	1492.02	1621.49	1750.95		350cm
400cm	770.76	914.15	1057.54	1200.91	1344.29	1487.68	1631.07	1774.61	Max. 10m <sup>2</sup>		400cm

### 4830 – Hardware only

Headrail supplied ready-assembled including adhesive tape for customers to mount own fabric.  
White aluminium bottom bar included as standard.

Width ►	100cm	125cm	150cm	175cm	200cm	225cm	250cm	275cm	300cm	330cm	◀ Width
	270.14	288.35	306.61	324.82	343.04	361.26	379.51	397.73	415.98	437.82	

**Fascia 4702:** Optional fascia covers roller blind headrail. Available in silver or white.  
**Pricing:** Add to prices above the following: £30.75/m width + £60.09/system

**Side-Guiding:** Side-guide wires with accessories: Please add £51.24 per system.

**Crank operation:** Fixed crank (150cm) add £37.00 per system.  
Detachable crank (150cm) add £47.50 per system.  
To extend crank drop add an additional £1.53 per 10cm.

### System 4830 – Double System

There is no add-on for a double system. Simply price as two separate systems and order a double system.



# Roller Blinds

## System 4830 – Side-by-Side System

Heavy duty chain operated Roller Blind system.  
 Tube diameter 55mm.  
 Max. surface area 10m<sup>2</sup>  
 (5m<sup>2</sup> for each panel of side by side system)

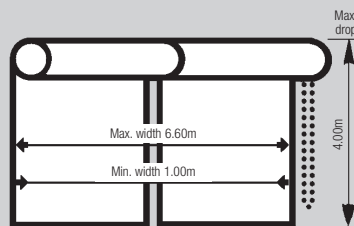

## System 4830 – Side-by-Side System complete with fabric

The prices below comprise the complete system made-to-measure, ready to hang with fabric of your choice. Please be aware that due to the size capabilities of this system, larger sizes can only be achieved by welding the fabric. Fabrics that can be welded are indicated below in bold print. If a system is required as a double system smaller than widths indicated below, please add **£85.79** to single system price. Please consult application chart (page 52) to ensure that fabric desired can be supplied in dimensions required.

Price Category C

### Price Group 1R

Colorama 1  
 Colorama 1 Alu  
 Element  
**Puma**  
**Basic Screen 5%**

Width ► Drop ▼	350cm	375cm	400cm	425cm	450cm	475cm	500cm	525cm	550cm	575cm	600cm	625cm	660cm	◀Width ▼ Drop
50cm	701.51	729.02	756.47	783.93	811.43	838.90	866.34	893.82	921.32	948.76	976.25	1003.72	1042.21	50cm
100cm	766.24	798.34	830.45	862.53	894.66	926.76	958.83	990.95	1023.02	1055.13	1087.24	1119.31	1164.25	100cm
150cm	830.97	867.69	904.42	941.16	977.89	1014.60	1051.29	1088.03	1124.74	1161.48	1198.16	1234.95	1286.30	150cm
200cm	895.72	937.05	978.37	1019.73	1061.09	1102.41	1143.78	1185.12	1226.47	1267.79	1309.14	1350.49	1408.35	200cm
250cm	960.42	1006.40	1052.37	1098.30	1144.29	1190.27								250cm
300cm	1025.17	1075.76												300cm
350cm														350cm
400cm														400cm

Max. 10m<sup>2</sup>

### Price Group 2R

Alutex  
 Colorama 2  
 Colorama 2 Alu  
 Colorama 2 Bioactive  
 Mercurio B  
 Multi Shadow  
 Multi Visio  
**Multiscreen 1%**  
**Multiscreen 5%**  
**Multiscreen 10%**

Newlife Screen  
 Optiscreen  
 Silente 20  
**Triscreen 1%**  
**Triscreen 3%**  
**Triscreen 5%**  
**Versascreen 1%**  
**Versascreen 5%**  
**Versascreen 10%**

Width ► Drop ▼	350cm	375cm	400cm	425cm	450cm	475cm	500cm	525cm	550cm	575cm	600cm	625cm	660cm	◀Width ▼ Drop
50cm	783.79	817.12	850.51	883.87	917.20	950.55	983.93	1017.26	1050.61	1083.95	1117.31	1150.65	1197.37	50cm
100cm	889.68	930.56	971.49	1012.42	1053.33	1094.23	1135.17	1176.08	1216.98	1257.87	1298.76	1339.71	1396.98	100cm
150cm	995.54	1044.02	1092.48	1140.97	1189.44	1237.87	1286.38	1334.88	1383.31	1431.81	1480.31	1528.74	1596.63	150cm
200cm	1101.41	1157.30	1213.47	1269.51	1325.55	1381.61	1437.64	1493.70	1549.74	1605.74	1661.78	1717.79	1796.28	200cm
250cm	1207.29	1270.90	1334.48	1398.03	1461.66	1525.29								250cm
300cm	1313.13	1384.31												300cm
350cm														350cm
400cm														400cm

Max. 10m<sup>2</sup>

### Price Group 3R

**Aluscreen Futura**  
 Deep  
 Ecoscreen  
 Jumbotex  
 Lightscreen  
 Linea  
 Linea Alu  
 Moon  
 Newlife 1  
 Newlife 2

Newlife Screen Alu  
 Optiscreen Alu  
 Reflex  
 Safescreen  
 Silente 10  
 Twin Blackout

Width ► Drop ▼	350cm	375cm	400cm	425cm	450cm	475cm	500cm	525cm	550cm	575cm	600cm	625cm	660cm	◀Width ▼ Drop
50cm	961.43	1007.45	1053.52	1099.57	1145.61	1191.63	1237.68	1283.72	1329.78	1375.77	1421.85	1467.87	1532.33	50cm
100cm	1156.11	1216.07	1276.00	1335.96	1395.90	1455.81	1515.79	1575.71	1635.72	1695.62	1755.61	1815.54	1899.44	100cm
150cm	1350.79	1424.64	1498.51	1572.35	1646.23	1720.05	1793.90	1867.78	1941.60	2015.49	2089.33	2163.18	2266.56	150cm
200cm	1545.51	1633.25	1721.02	1808.78	1896.53	1984.29	2072.06	2159.81	2247.55	2335.33	2423.09	2510.83	2633.70	200cm
250cm	1740.19	1841.85	1943.53	2045.18	2146.81	2248.51								250cm
300cm	1934.87	2050.43												300cm
350cm														350cm
400cm														400cm

Max. 10m<sup>2</sup>

## 4830 Side-by-Side System – Hardware only

Double headrail system supplied ready-assembled including adhesive tape for customers to mount own fabric. White aluminium bottom bar included as standard.

Width ►	100cm	150cm	200cm	250cm	300cm	350cm	400cm	450cm	500cm	550cm	600cm	660cm	◀Width
	389.77	426.25	462.71	499.18	535.59	572.04	608.55	644.96	681.43	717.86	754.34	798.06	

**Fascia 4702:** Optional fascia covers roller blind headrail. Available in silver or white.  
**Pricing:** Add to prices above the following: **£30.75/m width + £66.21/system**

**Side-Guiding:** Side-guide wires with accessories: Please add **£102.48** per double system.

Prices shown exclude VAT



# Roller Blinds

## System 4840

Heavy duty chain operated  
Roller Blind system.  
Tube diameter 80mm (up to 3.95m width).  
Tube diameter 110mm (over 3.95m width).  
Max. surface area 15m<sup>2</sup>

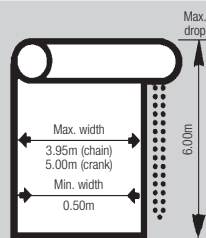

### System 4840 complete with fabric

The prices below comprise the complete system made-to-measure, ready to hang with fabric of your choice. Please be aware that due to the size capabilities of this system, larger sizes can only be achieved by welding the fabric. Fabrics that can be welded are indicated below in bold print. Please consult application chart (page 52) to ensure that the fabric desired can be supplied in dimensions required. System sizes in shaded areas are available as crank operated only (fixed or detachable).

Price Category C

#### Price Group 1R

Colorama 1  
Colorama 1 Alu  
Element  
**Puma**  
**Basic Screen 5%**

Width ► Drop ▼	100cm	150cm	200cm	250cm	300cm	350cm	400cm	450cm	500cm	◀ Width ▼ Drop
50cm	602.43	671.16	739.90	808.59	877.33	946.03	1063.19	1131.87	1200.60	50cm
100cm	620.22	697.81	775.49	853.08	930.69	1008.29	1134.37	1211.95	1289.59	100cm
150cm	638.01	724.53	811.04	897.56	984.05	1070.59	1205.54	1292.04	1378.52	150cm
200cm	655.79	751.22	846.64	942.04	1037.41	1132.81	1276.72	1372.10	1467.52	200cm
250cm	673.65	777.89	882.21	986.53	1090.79	1195.11	1347.85	1452.16	1556.48	250cm
300cm	691.38	804.56	917.81	1031.00	1144.19	1257.39	1419.01	1532.18	1645.33	300cm
350cm	709.19	831.25	953.39	1075.47	1197.58	1319.65	1490.19			350cm
400cm	727.01	857.97	988.96	1119.97	1250.97	1381.94				400cm
450cm	744.79	884.67	1024.55	1164.44	1304.31					450cm
500cm	762.57	911.32	1060.08	1208.94	1357.70					500cm
550cm	780.36	938.04	1095.70	1253.37						550cm
600cm	798.17	964.71	1131.28	1297.86					Max. 15m <sup>2</sup>	600cm

#### Price Group 2R

Alutex  
Colorama 2  
Colorama 2 Alu  
Colorama 2 Bioactive  
Mercurio B  
Multi Shadow  
Multi Visio  
**Multiscreen 1%**  
**Multiscreen 5%**  
**Multiscreen 10%**

Newlife Screen  
Optiscreen  
Silente 20  
**Triscreen 1%**  
**Triscreen 3%**  
**Triscreen 5%**  
**Versascreen 1%**  
**Versascreen 5%**  
**Versascreen 10%**

Width ► Drop ▼	100cm	150cm	200cm	250cm	300cm	350cm	400cm	450cm	500cm	◀ Width ▼ Drop
50cm	625.02	705.00	785.05	865.05	945.07	1025.12	1153.53	1233.53	1313.55	50cm
100cm	654.08	748.68	843.20	937.76	1032.32	1126.88	1269.89	1364.41	1458.99	100cm
150cm	683.20	792.30	901.39	1010.48	1119.57	1228.67	1386.21	1495.33	1604.43	150cm
200cm	712.29	835.92	959.54	1083.24	1206.85	1330.50	1502.59	1626.22	1749.81	200cm
250cm	741.36	879.56	1017.74	1155.95	1294.08	1432.26	1618.93	1757.06	1895.25	250cm
300cm	770.46	923.18	1075.90	1228.61	1381.36	1534.05	1735.25	1887.96	2040.71	300cm
350cm	799.54	966.79	1134.05	1301.35	1468.61	1635.87	1851.58			350cm
400cm	828.62	1010.43	1192.23	1374.08	1555.88	1737.69				400cm
450cm	857.71	1054.02	1250.42	1446.78	1643.12					450cm
500cm	886.78	1097.69	1308.62	1519.50	1730.40					500cm
550cm	915.92	1141.33	1366.75	1592.21						550cm
600cm	944.98	1184.96	1424.92	1664.90					Max. 15m <sup>2</sup>	600cm

#### Price Group 3R

Aluscreen Futura  
Deep  
Ecoscreen  
Jumbotex  
Lightscreen  
Linea  
Linea Alu  
Moon  
Newlife 1  
Newlife 2

Newlife Screen Alu  
Optiscreen Alu  
Reflex  
Safescreen  
Silente 10  
Twin Blackout

Width ► Drop ▼	100cm	150cm	200cm	250cm	300cm	350cm	400cm	450cm	500cm	◀ Width ▼ Drop
50cm	673.82	778.26	882.70	987.09	1091.54	1195.94	1348.79	1453.24	1557.63	50cm
100cm	727.29	858.48	989.67	1120.82	1251.98	1383.12	1562.78	1693.93	1825.08	100cm
150cm	780.85	938.72	1096.63	1254.55	1412.47	1570.42	1776.72	1934.64	2092.59	150cm
200cm	834.32	1018.95	1203.66	1388.30	1572.94	1757.62	1990.72	2175.38	2360.03	200cm
250cm	887.81	1099.21	1310.61	1522.06	1733.41	1944.84	2204.70	2416.08	2627.49	250cm
300cm	941.30	1179.45	1417.62	1655.73	1893.92	2132.08	2418.63	2656.80	2895.01	300cm
350cm	994.80	1259.70	1524.57	1789.50	2054.41	2319.29	2632.62			350cm
400cm	1048.28	1339.94	1631.60	1923.22	2214.89	2506.51				400cm
450cm	1101.80	1420.14	1738.56	2056.99	2375.35					450cm
500cm	1155.28	1500.42	1845.54	2190.68	2535.84					500cm
550cm	1208.75	1580.66	1952.56	2324.43						550cm
600cm	1262.25	1660.87	2059.50	2458.20					Max. 15m <sup>2</sup>	600cm

Note: All fabrics are FR

Should crank operated be required for systems under 3.95m width add the following supplement to the system prices above.

Fixed crank (150cm): **£37.00** per system

Detachable crank (150cm): **£47.50** per system

To extend crank drop add an additional **£1.53** per 10cm

Side-Guiding of System 4840 Side-guide wires are available as an option. Please add **£175.74** per system (Cat. 'C').

Prices shown exclude VAT









# Roller Blinds

## System 4870

Heavy duty electrically operated Roller Blind system. Mains voltage. Speed approx. 7cm/sec. Tube diameter 55mm. Max. surface area 14m<sup>2</sup>

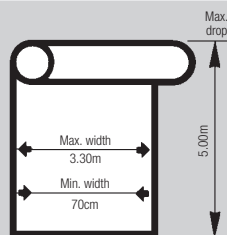

### System 4870 complete with fabric

The prices below comprise the complete system made-to-measure, ready to hang with fabric of your choice. Please be aware that due to the size capabilities of this system, larger sizes can only be achieved by welding the fabric. Fabrics that can be welded are indicated below in bold print. Please consult application chart (page 52) to ensure that fabric desired can be supplied in dimensions required.

Price Category C

#### Price Group 1R

Colorama 1  
Colorama 1 Alu  
Element  
**Puma**  
Basic Screen 5%

Width ► Drop ▼	100cm	125cm	150cm	175cm	200cm	225cm	250cm	275cm	300cm	330cm	◀ Width ▼ Drop
50cm	1035.39	1056.51	1077.65	1098.79	1119.90	1141.02	1162.16	1183.31	1204.41	1229.77	50cm
100cm	1053.73	1079.41	1105.13	1130.86	1156.56	1182.25	1207.97	1233.67	1259.36	1290.20	100cm
150cm	1072.06	1102.33	1132.61	1162.90	1193.19	1223.46	1253.72	1284.02	1314.33	1350.66	150cm
200cm	1090.35	1125.20	1160.06	1194.95	1229.82	1264.68	1299.52	1334.39	1369.27	1411.10	200cm
250cm	1108.68	1148.13	1187.56	1227.00	1266.46	1305.86	1345.32	1384.78	1424.21	1471.52	250cm
300cm	1126.99	1170.99	1215.05	1259.03	1303.06	1347.12	1391.13	1435.14	1479.17	1532.00	300cm
350cm	1145.31	1193.89	1242.53	1291.12	1339.72	1388.30	1436.88	1485.52	1534.09	1592.41	350cm
400cm	1163.62	1216.81	1269.98	1323.18	1376.34	1429.51	1482.71	1535.89	1589.05	1652.86	400cm
450cm	1181.95	1239.67	1297.47	1355.20	1412.99	1470.71	1528.51	1586.25	1644.02		450cm
500cm	1200.23	1262.58	1324.92	1387.25	1449.59	1511.94	1574.30	1636.59		Max. 14m <sup>2</sup>	500cm

#### Price Group 2R

Alutex  
Colorama 2  
Colorama 2 Alu  
Colorama 2 Bioactive  
Mercurio B  
Multi Shadow  
Multi Visio  
**Multiscreen 1%**  
**Multiscreen 5%**  
**Multiscreen 10%**

Newlife Screen  
Optiscreen  
Silente 20  
**Triscreen 1%**  
**Triscreen 3%**  
**Triscreen 5%**  
**Versascreen 1%**  
**Versascreen 5%**  
**Versascreen 10%**

Width ► Drop ▼	100cm	125cm	150cm	175cm	200cm	225cm	250cm	275cm	300cm	330cm	◀ Width ▼ Drop
50cm	1047.06	1071.07	1095.11	1119.15	1143.21	1167.22	1191.27	1215.29	1239.35	1268.17	50cm
100cm	1077.02	1108.53	1140.05	1171.57	1203.14	1234.63	1266.17	1297.67	1329.20	1367.06	100cm
150cm	1106.98	1145.98	1185.00	1224.00	1263.02	1302.03	1341.05	1380.08	1419.10	1465.89	150cm
200cm	1136.92	1183.44	1229.93	1276.44	1322.94	1369.42	1415.95	1462.44	1508.97	1564.75	200cm
250cm	1166.85	1220.88	1274.87	1328.87	1382.87	1436.84	1490.85	1544.82	1598.81	1663.60	250cm
300cm	1196.83	1258.32	1319.81	1381.31	1442.75	1504.26	1565.73	1627.23	1688.72	1762.48	300cm
350cm	1226.80	1295.72	1364.73	1433.70	1517.69	1571.67	1640.65	1709.59	1778.60	1861.36	350cm
400cm	1256.76	1333.20	1409.70	1486.13	1562.62	1639.08	1715.53	1791.99	1868.42	1960.19	400cm
450cm	1286.72	1370.64	1454.61	1538.57	1622.51	1706.47	1790.44	1874.37	1958.34		450cm
500cm	1316.63	1408.12	1499.55	1591.01	1682.43	1773.86	1865.30	1956.78		Max. 14m <sup>2</sup>	500cm

#### Price Group 3R

Aluscreen Futura  
Deep  
Ecoscreen  
Jumbotex  
Lightscreen  
Linea  
Linea Alu  
Moon  
Newlife 1  
Newlife 2

Newlife Screen Alu  
Optiscreen Alu  
Reflex  
Safescreen  
Silente 10  
Twin Blackout

Width ► Drop ▼	100cm	125cm	150cm	175cm	200cm	225cm	250cm	275cm	300cm	330cm	◀ Width ▼ Drop
50cm	1072.20	1102.47	1132.79	1163.16	1193.46	1223.78	1254.08	1284.38	1314.76	1351.10	50cm
100cm	1127.28	1171.36	1215.46	1259.54	1303.66	1347.74	1391.82	1435.91	1480.02	1532.92	100cm
150cm	1182.38	1240.23	1298.10	1355.95	1413.80	1471.72	1529.56	1587.39	1645.30	1714.71	150cm
200cm	1237.43	1309.09	1380.71	1452.37	1524.01	1595.62	1667.28	1738.91	1810.55	1896.53	200cm
250cm	1292.54	1377.95	1463.35	1548.77	1634.20	1719.60	1805.01	1890.43	1975.86	2078.30	250cm
300cm	1347.64	1446.82	1546.01	1645.19	1744.37	1843.57	1942.74	2041.89	2141.08	2260.08	300cm
350cm	1402.73	1515.66	1628.64	1741.57	1854.56	1967.50	2080.46	2193.40	2306.37	2441.91	350cm
400cm	1457.80	1584.53	1711.27	1837.98	1964.75	2091.46	2218.21	2344.92	2471.65	2623.69	400cm
450cm	1512.90	1653.38	1793.90	1934.40	2074.92	2215.42	2355.90	2496.40	2636.93		450cm
500cm	1567.97	1722.26	1876.56	2030.79	2185.10	2339.33	2493.63	2647.92		Max. 14m <sup>2</sup>	500cm

Note: All fabrics are FR

#### System 4870 Control Options

Radio control standard option is with System 0450, see page 24.

Radio control option with integrated receiver available only with 9940 controls – add on £164.31, see page 24.

#### System 4870 – Hardware only

Headrail system supplied ready-assembled including adhesive tape for customers to mount own fabric.

Bottom bar in white is included as standard.

Width ►	100cm	125cm	150cm	175cm	200cm	225cm	250cm	275cm	300cm	330cm	◀ Width
	1017.07	1033.64	1050.16	1066.72	1083.29	1099.81	1116.40	1132.92	1149.48	1169.33	

Fascia 4702: Optional fascia covers roller blind headrail. Available in silver or white.

Pricing: Add to prices above the following: £30.75/m width + £59.46/system

Side-Guiding: Side-guide wires with accessories: Please add £65.02 per system.

#### System 4870 – Double Bracket System

There is no add-on for a double system. Simply price as two separate systems and order a double system.

Prices shown exclude VAT



# Roller Blinds

## System 4870 – Side-by-Side System

Heavy duty electrically operated Roller Blind system. Mains voltage. Speed approx. 7cm/sec. Tube diameter 55mm.

Max. surface area 22m<sup>2</sup>  
(11m<sup>2</sup> for each panel of side by side system)

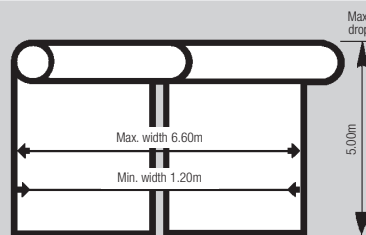

## System 4870 – Side-by-Side System

The prices below comprise the complete system made-to-measure, ready to hang with fabric of your choice. Please be aware that due to the size capabilities of this system, larger sizes can only be achieved by welding the fabric. Fabrics that can be welded are indicated below in bold print. If a system is required as a double system smaller than widths indicated below, please add £79.13 to single system price. Please consult application chart (page 52) to ensure that fabric desired can be supplied in dimensions required.

Price Category C

### Price Group 1R

Colorama 1  
Colorama 1 Alu  
Element  
**Puma**  
Basic Screen 5%

Width ▶ Drop ▼	350cm	375cm	400cm	425cm	450cm	475cm	500cm	525cm	550cm	575cm	600cm	625cm	660cm	◀Width ▼ Drop
50cm	1350.25	1371.39	1392.54	1413.67	1434.79	1455.88	1477.02	1498.17	1519.27	1540.41	1561.52	1582.65	1612.23	50cm
100cm	1414.36	1440.08	1465.78	1491.50	1517.19	1542.91	1568.64	1594.32	1620.03	1645.72	1671.43	1697.14	1733.12	100cm
150cm	1478.47	1508.73	1539.03	1569.33	1599.61	1629.89	1660.18	1690.46	1720.74	1751.00	1781.33	1811.63	1853.99	150cm
200cm	1542.61	1577.46	1612.32	1647.18	1682.04	1716.89	1751.75	1786.65	1821.50	1856.38	1891.21	1926.06	1974.89	200cm
250cm	1606.69	1646.16	1685.58	1725.02	1764.47	1803.89	1843.34	1882.82	1922.22	1961.69	2001.10	2040.56	2095.76	250cm
300cm	1670.81	1714.83	1758.87	1802.87	1846.88	1890.91	1934.93	1978.94	2022.95	2066.99	2111.01	2155.03	2216.67	300cm
350cm	1734.92	1783.50	1832.11	1880.72	1929.32	1977.87	2026.52	2075.08	2123.71	2172.30	2220.92	2269.52		350cm
400cm	1799.00	1852.20	1905.40	1958.49	2011.72	2064.91	2118.09	2171.27	2224.44	2277.64	2330.82			400cm
450cm	1863.10	1920.88	1978.65	2036.42	2094.17	2151.93	2209.68	2267.45						450cm
500cm	1927.19	1989.57	2051.90	2114.24	2176.58									500cm

Max. 22m<sup>2</sup>

### Price Group 2R

Alutex  
Colorama 2  
Colorama 2 Alu  
Colorama 2 Bioactive  
Mercurio B  
Multi Shadow  
Multi Visio  
**Multiscreen 1%**  
**Multiscreen 5%**  
**Multiscreen 10%**

Newlife Screen  
Optiscreen  
Silente 20  
**Triscreen 1%**  
**Triscreen 3%**  
**Triscreen 5%**  
**Versascreen 1%**  
**Versascreen 5%**  
**Versascreen 10%**

Width ▶ Drop ▼	350cm	375cm	400cm	425cm	450cm	475cm	500cm	525cm	550cm	575cm	600cm	625cm	660cm	◀Width ▼ Drop
50cm	1391.00	1415.02	1439.08	1463.13	1487.14	1511.19	1535.18	1559.28	1583.31	1607.34	1631.35	1655.40	1689.09	50cm
100cm	1495.85	1527.39	1559.27	1590.44	1621.97	1653.49	1685.01	1716.54	1748.07	1779.57	1811.13	1842.65	1886.78	100cm
150cm	1600.71	1639.73	1678.74	1717.75	1756.77	1795.80	1834.80	1873.80	1912.82	1951.82	1990.86	2029.86	2084.51	150cm
200cm	1705.56	1752.07	1798.59	1845.07	1891.56	1938.10	1984.61	2031.10	2077.61	2124.10	2170.60	2217.14	2282.22	200cm
250cm	1810.42	1864.42	1918.42	1972.41	2026.38	2080.42	2134.37	2188.37	2242.36	2296.37	2350.36	2404.36	2479.96	250cm
300cm	1915.27	1976.74	2038.23	2099.72	2161.18	2222.71	2284.18	2345.66	2407.16	2468.62	2530.10	2591.59	2677.65	300cm
350cm	2020.14	2089.07	2158.10	2227.05	2296.04	2365.00	2433.95	2502.95	2571.88	2640.88	2709.85	2778.81		350cm
400cm	2124.97	2201.46	2277.89	2354.36	2430.84	2507.30	2583.74	2660.28	2736.67	2813.16	2889.56			400cm
450cm	2229.81	2313.79	2397.74	2481.68	2565.64	2649.58	2733.53	2817.50						450cm
500cm	2334.68	2426.14	2517.60	2609.00	2700.46									500cm

### Price Group 3R

Aluscreen Futura  
Deep  
Ecoscreen  
Jumbotex  
Lightscreen  
Linea  
Linea Alu  
Moon  
Newlife 1  
Newlife 2

Newlife Screen Alu  
Optiscreen Alu  
Reflex  
Safescreen  
Silente 10  
Twin Blackout

Width ▶ Drop ▼	350cm	375cm	400cm	425cm	450cm	475cm	500cm	525cm	550cm	575cm	600cm	625cm	660cm	◀Width ▼ Drop
50cm	1478.96	1509.27	1539.63	1569.94	1600.27	1630.57	1660.87	1660.87	1782.17	1751.84	1782.17	1812.47	1854.96	50cm
100cm	1671.79	1715.88	1759.98	1804.05	1848.18	1892.27	1936.35	1980.44	2024.54	2068.63	2113.22	2156.82	2218.53	100cm
150cm	1864.60	1922.15	1980.36	2038.21	2096.09	2153.92	2211.80	2269.65	2327.52	2385.39	2443.26	2501.11	2582.14	150cm
200cm	2057.43	2129.06	2200.70	2272.34	2343.96	2415.61	2487.26	2558.87	2630.51	2702.18	2773.82	2845.46	2945.71	200cm
250cm	2250.23	2335.64	2421.08	2506.47	2591.88	2677.30	2762.68	2848.10	2933.52	3018.95	3104.34	3189.74	3309.36	250cm
300cm	2443.07	2542.22	2641.43	2740.62	2839.81	2938.98	3038.18	3137.31	3236.52	3335.69	3434.85	3534.06	3672.95	300cm
350cm	2635.91	2748.83	2861.80	2974.74	3087.70	3200.64	3313.61	3426.59	3539.51	3652.50	3765.45	3878.39		350cm
400cm	2828.70	2955.44	3082.15	3208.88	3335.58	3462.31	3589.07	3715.80	3842.53	3969.26				400cm
450cm	3021.51	3161.98	3302.52	3443.02	3583.50	3724.00	3864.50	4005.93						450cm
500cm	3214.29	3368.64	3522.90	3677.16										500cm

### System 4870 Side-by-Side Control Options

Radio control standard option is with System 0450, see page 24.

Radio control option with integrated receiver available only with 9940 controls – add on £164.31, see page 24.

Note: All fabrics are FR.

### System 4870 Side-by-Side System – Hardware only

Double headrail system supplied ready-assembled including adhesive tape for customers to mount own fabric. Bottom bar in white is included as standard.

Width ▶ Drop ▼	100cm	150cm	200cm	250cm	300cm	350cm	400cm	450cm	500cm	550cm	600cm	660cm	◀Width ▼ Drop
	1120.68	1153.78	1186.90	1219.96	1253.05	1286.18	1319.27	1352.31	1385.44	1418.53	1451.63	1491.32	

**Fascia 4702:** Optional fascia covers roller blind headrail. Available in silver or white.

**Pricing:** Add to prices above the following: **£30.75/m width + £67.83/system**

**Side-Guiding:** Side-guide wires with accessories: Please add **£101.54** per side-by-side system.

Prices shown exclude VAT







# Dim-out Roller Blinds

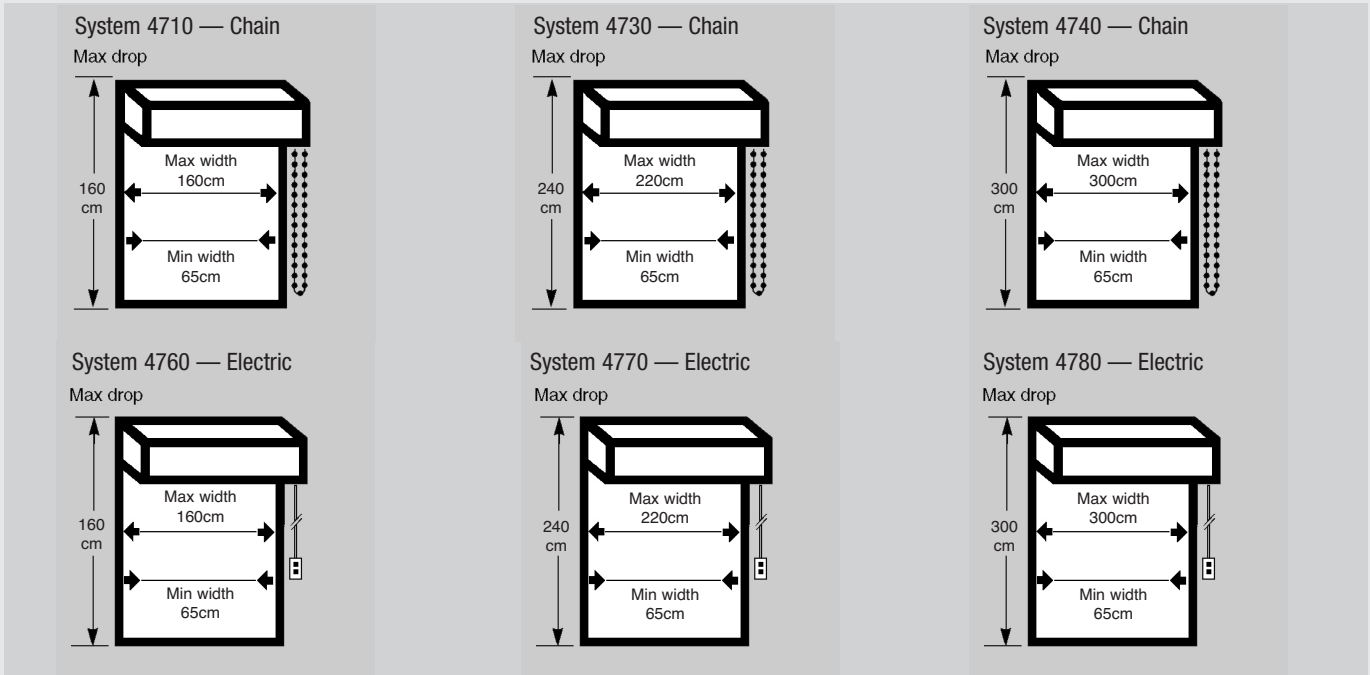

Price category C

The prices in the tables comprise the complete system made-to-measure, with fabric chosen, ready to install.

If sizes lie between the measurements shown, the price for the next larger size will apply.

**Colours:** White or black available as standard. Silver/bronze anodized or standard RAL colours are available at extra cost as follows:-  
 £55.00/m width Price cat. 'C'  
 £55.00/m drop Price cat. 'C'

Delivery: 4 weeks.

Charges are for headrail/side legs — + bottom rails only, accessories available in white or black only.

**Note:** Laminated customer own fabric not available.  
 \* If welded, white not recommended as discolours.

## System 4710 - Chain (Headbox size: 73mm)

### Price Group 1R

Puma

Width	65cm	80cm	100cm	120cm	140cm	160cm	Width
Drop (cm)							Drop (cm)
60	220.85	236.70	257.80	278.95	300.10	321.20	60
80	239.45	255.30	276.40	297.55	318.70	339.80	80
100	258.05	273.90	295.00	316.15	337.30	358.40	100
120	276.65	292.50	313.60	334.75	355.90	377.00	120
140	295.25	311.10	332.20	353.35	374.50	395.60	140
160	313.85	329.70	350.80	371.95	393.10	414.20	160

### Price Group 2R

Basic Screen

Width	65cm	80cm	100cm	120cm	140cm	160cm	Width
Drop (cm)							Drop (cm)
60	297.00	312.85	334.00	355.10	376.25	397.40	60
80	325.15	341.00	362.10	383.25	404.35	425.50	80
100	353.25	369.10	390.25	411.35	432.50	453.60	100
120	381.40	397.25	418.35	439.50	460.60	481.75	120
140	409.50	425.35	446.50	467.60	488.75	509.85	140
160	437.60	453.45	474.60	495.70	516.85	538.00	160

### Price Group 3R

Moon and Lightscreen

Width	65cm	80cm	100cm	120cm	140cm	160cm	Width
Drop (cm)							Drop (cm)
60	349.66	365.51	386.66	407.81	428.91	450.06	60
80	384.38	400.23	421.38	442.48	463.63	484.78	80
100	419.09	434.94	456.09	477.19	498.34	519.44	100
120	453.80	469.65	490.75	511.90	533.05	554.15	120
140	488.52	504.37	525.47	546.62	567.72	588.87	140
160	523.18	539.03	560.18	581.33	602.43	623.58	160

All prices shown exclude VAT







## Dim-Out Roller Blind System 4760 - Electric (Headbox size: 73mm)

Price category C

### Price Group 1R - Puma

Width	65cm	80cm	100cm	120cm	140cm	160cm	Width
Drop cm							Drop cm
60	722.05	744.24	773.78	803.39	833.00	862.54	60
80	748.09	770.28	799.82	829.43	859.04	888.58	80
100	774.13	796.32	825.86	855.47	885.08	914.62	100
120	800.17	822.36	851.90	881.51	911.12	940.66	120
140	826.21	848.40	877.94	907.55	937.16	966.70	140
160	852.25	874.44	903.98	933.59	963.20	992.74	160

### Price Group 2R - Basic Screen

Width	65cm	80cm	100cm	120cm	140cm	160cm	Width
Drop cm							Drop cm
60	828.66	850.85	880.46	910.00	939.61	969.22	60
80	868.07	890.26	919.80	949.41	978.95	1008.56	80
100	907.41	929.60	959.21	988.75	1018.36	1047.90	100
120	946.82	968.94	998.55	1028.16	1057.70	1087.31	120
140	986.16	1008.35	1037.89	1067.50	1097.11	1126.65	140
160	1025.50	1047.69	1077.30	1106.84	1136.45	1166.06	160

### Price Group 3R - Moon and Lightscreen

Width	65cm	80cm	100cm	120cm	140cm	160cm	Width
Drop cm							Drop cm
60	902.34	924.53	954.14	983.75	1013.29	1042.90	60
80	950.94	973.13	1002.74	1032.28	1061.89	1091.50	80
100	999.53	1021.72	1051.33	1080.87	1110.48	1140.02	100
120	1048.12	1070.31	1099.85	1129.46	1159.07	1188.61	120
140	1096.72	1118.91	1148.45	1178.06	1207.60	1237.21	140
160	1145.24	1167.43	1197.04	1226.65	1256.19	1285.80	160

Integrated receiver for use with 9940 add £164.31.

## Dim-Out Roller Blind System 4770 - Electric (Headbox size: 90mm)

Price category C

### Price Group 1R - Puma

Width	65cm	80cm	100cm	120cm	140cm	160cm	180cm	200cm	220cm	Width
Drop cm										Drop cm
60	730.10	753.90	785.61	817.32	849.03	880.81	1053.22	1084.93	1116.64	60
80	756.14	779.94	811.65	843.36	875.07	906.85	1096.83	1128.54	1160.25	80
100	782.18	805.98	837.69	869.40	901.11	932.89	1140.44	1172.15	1203.86	100
120	808.22	832.02	863.73	895.44	927.15	958.93	1184.05	1215.76	1247.54	120
140	834.26	858.06	889.77	921.48	953.19	984.97	1227.66	1259.44	1291.15	140
160	860.30	884.10	915.81	947.52	979.23	1011.01	1271.34	1303.05	1334.76	160
180	886.34	910.14	941.85	973.56	1005.27	1037.05	1314.95	1346.66	1378.37	180
200	912.38	936.18	967.89	999.60	1031.31	1063.09	1358.56	1390.27	1421.98	200
220	938.42	962.22	993.93	1025.64	1057.35	1089.06	1402.17	1433.88	1465.66	220
240	964.46	988.26	1019.97	1051.68	1083.39	1115.10	1445.78	1477.56	1509.27	240

### Price Group 2R - Basic Screen

Width	65cm	80cm	100cm	120cm	140cm	160cm	180cm	200cm	220cm	Width
Drop cm										Drop cm
60	836.71	860.51	892.22	924.00	955.71	987.42	1019.13	1094.17	1125.88	60
80	876.12	899.92	931.63	963.34	995.05	1026.76	1058.44	1138.90	1170.68	80
100	915.46	939.26	970.97	1002.68	1034.46	1066.17	1097.88	1183.70	1215.41	100
120	954.87	978.60	1010.38	1042.09	1073.80	1105.51	1137.22	1228.50	1260.21	120
140	994.21	1018.01	1049.72	1081.43	1113.14	1144.92	1176.63	1273.23	1305.01	140
160	1033.55	1057.35	1089.06	1120.84	1152.55	1184.26	1215.97	1318.03	1349.74	160
180	1072.96	1096.76	1128.47	1160.18	1191.89	1223.60	1255.38	1362.83	1394.54	180
200	1112.30	1136.10	1167.81	1199.52	1231.30	1263.01	1294.72	1407.56	1439.34	200
220	1151.71	1175.44	1207.22	1238.93	1270.64	1302.35	1334.06	1452.36	1484.07	220
240	1191.05	1214.85	1246.56	1278.27	1309.98	1341.76	1373.47	1497.16	1528.87	240

### Price Group 3R - Moon and Lightscreen

Width	65cm	80cm	100cm	120cm	140cm	160cm	180cm	200cm	220cm	Width
Drop cm										Drop cm
60	910.46	934.19	965.97	997.68	1029.39	1061.10	1092.81	1124.59	1156.30	60
80	958.99	982.79	1014.50	1046.28	1077.99	1109.70	1141.41	1173.12	1204.90	80
100	1007.58	1031.38	1063.09	1094.80	1126.58	1158.29	1190.00	1221.71	1253.42	100
120	1056.17	1079.97	1111.68	1143.39	1175.10	1206.88	1238.59	1270.30	1302.01	120
140	1104.77	1128.57	1160.28	1191.99	1223.70	1255.41	1287.19	1318.90	1350.61	140
160	1153.36	1177.09	1208.87	1240.58	1272.29	1304.00	1335.71	1367.49	1399.20	160
180	1201.89	1225.69	1257.40	1289.18	1320.89	1352.60	1384.31	1416.02	1447.80	180
200	1250.48	1274.28	1305.99	1337.70	1369.48	1401.19	1432.90	1464.61	1496.32	200
220	1299.07	1322.87	1354.58	1386.29	1418.00	1449.78	1481.49	1513.20	1544.91	220
240	1347.67	1371.47	1403.18	1434.89	1466.60	1498.31	1530.09	1561.80	1593.51	240

Integrated receiver for use with 9940 add £164.31.

All prices shown exclude VAT



# Dim-Out Roller Blind System 4780 - Electric (Headbox size: 110mm)

Price category C

## Price Group 1R - Puma

Width	65cm	80cm	100cm	120cm	140cm	160cm	180cm	200cm	220cm	240cm	260cm	280cm	300cm	Width
Drop cm														Drop cm
60	844.01	875.14	916.65	958.16	999.74	1041.25	1223.46	1264.97	1306.48	1347.99	1389.57	1431.08	1472.59	60
80	870.05	901.18	942.69	984.20	1025.78	1067.29	1267.07	1308.58	1350.09	1391.67	1433.18	1474.69	1516.20	80
100	896.09	927.22	968.73	1010.24	1051.82	1093.33	1310.68	1352.19	1393.77	1435.28	1476.79	1518.30	1559.81	100
120	922.13	953.26	994.77	1036.28	1077.86	1119.37	1354.29	1395.87	1437.38	1478.89	1520.40	1561.91	1603.49	120
140	948.17	979.30	1020.81	1062.32	1103.90	1145.41	1397.97	1439.48	1480.99	1522.50	1564.01	1605.59	1647.10	140
160	974.21	1005.34	1046.85	1088.36	1129.94	1171.45	1441.58	1483.09	1524.60	1566.11	1607.69	1649.20	1690.71	160
180	1000.25	1031.38	1072.89	1114.40	1155.91	1197.49	1485.19	1526.70	1568.21	1609.79	1651.30	1692.81	1734.32	180
200	1026.29	1057.42	1098.93	1140.44	1181.95	1223.53	1528.80	1570.31	1611.89	1653.40	1694.91	1736.42	1777.93	200
220	1052.33	1083.46	1124.97	1166.48	1207.99	1249.57	1572.41	1613.99	1655.50	1697.01	1738.52	1780.03	1821.61	220
240	1078.37	1109.50	1151.01	1192.52	1234.03	1275.61	1616.09	1657.60	1699.11	1740.62	1782.13	1823.71	1865.22	240
260	1104.41	1135.54	1177.05	1218.56	1260.07	1301.65	1659.70	1701.21	1742.72	1784.23	1825.81	1867.32	1908.83	260
280	1130.45	1161.58	1203.09	1244.60	1286.11	1327.69	1703.31	1744.82	1786.33	1827.91	1869.42	1910.93	1952.44	280
300	1156.49	1187.62	1229.13	1270.64	1312.15	1353.73	1746.92	1788.43	1830.01	1871.52	1913.03	1954.54	1996.05	300

## Price Group 2R - Basic Screen

Width	65cm	80cm	100cm	120cm	140cm	160cm	180cm	200cm	220cm	240cm	260cm	280cm	300cm	Width
Drop cm														Drop cm
60	997.57	1031.38	1076.46	1121.54	1166.69	1211.77	1256.85	1301.93	1437.17	1482.25	1527.33	1572.48	1617.56	60
80	1026.55	1060.36	1105.44	1150.59	1195.67	1240.75	1285.83	1330.91	1477.42	1522.50	1567.65	1612.73	1657.81	80
100	1055.53	1089.41	1134.49	1179.57	1224.65	1269.73	1314.88	1359.96	1517.67	1562.82	1607.90	1652.98	1698.06	100
120	1084.58	1118.39	1163.47	1208.55	1253.63	1298.78	1343.86	1388.94	1557.99	1603.07	1648.15	1693.23	1738.31	120
140	1113.56	1147.37	1192.45	1237.53	1282.68	1327.76	1372.84	1417.92	1598.24	1643.32	1688.40	1733.48	1778.63	140
160	1142.54	1176.35	1221.43	1266.58	1311.66	1356.74	1401.82	1446.90	1638.49	1683.57	1728.65	1773.80	1818.88	160
180	1171.52	1205.33	1250.48	1295.56	1340.64	1385.72	1430.80	1475.95	1678.74	1723.82	1768.97	1814.05	1859.13	180
200	1200.57	1234.38	1279.46	1324.54	1369.62	1414.70	1459.85	1504.93	1718.99	1764.14	1809.22	1854.30	1899.38	200
220	1229.55	1263.36	1308.44	1353.52	1398.67	1443.75	1488.83	1533.91	1759.31	1804.39	1849.47	1894.55	1939.63	220
240	1258.53	1292.34	1337.42	1382.57	1427.65	1472.73	1517.81	1562.89	1799.56	1844.64	1889.72	1934.80	1979.95	240
260	1287.51	1321.32	1366.47	1411.55	1456.63	1501.71	1546.79	1591.94	1839.81	1884.89	1929.97	1975.12	2020.20	260
280	1316.49	1350.37	1395.45	1440.53	1485.61	1530.69	1575.84	1620.92	1880.06	1925.14	1970.29	2015.37	2060.45	280
300	1345.54	1379.35	1424.43	1469.51	1514.59	1559.74	1604.82	1649.90	1920.31	1965.46	2010.54	2055.62	2100.70	300

## Price Group 3R - Moon and Lightscreen

Width	65cm	80cm	100cm	120cm	140cm	160cm	180cm	200cm	220cm	240cm	260cm	280cm	300cm	Width
Drop cm														Drop cm
60	1024.30	1055.50	1097.01	1138.52	1180.03	1221.54	1263.12	1304.63	1346.14	1363.67	1655.64	1700.72	1745.80	60
80	1072.89	1104.03	1145.61	1187.12	1228.63	1270.14	1311.65	1353.23	1394.74	1412.25	1735.09	1780.17	1825.25	80
100	1121.49	1152.62	1194.13	1235.71	1277.22	1318.73	1360.24	1401.75	1443.33	1460.90	1814.54	1859.62	1904.70	100
120	1170.08	1201.21	1242.72	1284.23	1325.81	1367.32	1408.83	1450.34	1491.85	1509.48	1893.99	1939.07	1984.15	120
140	1218.68	1249.81	1291.32	1332.83	1374.34	1415.92	1457.43	1498.94	1540.45	1558.06	1973.37	2018.52	2063.60	140
160	1267.20	1298.40	1339.91	1381.42	1422.93	1464.44	1506.02	1547.53	1589.04	1606.64	2052.82	2097.97	2143.05	160
180	1315.79	1346.93	1388.51	1430.02	1471.53	1513.04	1554.55	1596.13	1637.64	1655.22	2132.27	2177.35	2222.50	180
200	1364.39	1395.52	1437.03	1478.61	1520.12	1561.63	1603.14	1644.65	1686.23	1703.80	2211.72	2256.80	2301.88	200
220	1412.98	1444.11	1485.62	1527.13	1568.71	1610.22	1651.73	1693.24	1734.75	1752.38	2291.17	2336.25	2381.33	220
240	1461.58	1492.71	1534.22	1575.73	1617.24	1658.82	1700.33	1741.84	1783.35	1800.96	2370.62	2415.70	2460.78	240
260	1510.10	1541.30	1582.81	1624.32	1665.83	1707.34	1748.92	1790.43	1831.94	1849.54	2450.07	2495.15	2540.23	260
280	1558.69	1589.83	1631.41	1672.92	1714.43	1755.94	1797.45	1839.03	1880.54	1898.12	2529.52	2574.60	2619.68	280
300	1607.29	1638.42	1679.93	1721.51	1763.02	1804.53	1846.04	1887.55	1929.13	1946.70	2608.90	2654.05	2699.13	300

Integrated receiver for use with 9940 add £164.31.

All prices shown exclude VAT



# Dim-Out Skylight Roller Blinds

## System 4590 – Crank

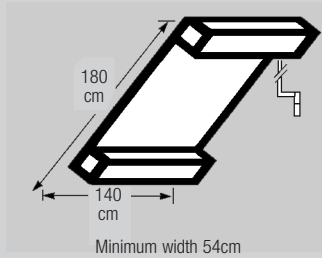

## System 4595 – Electric

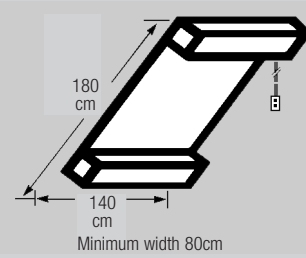

## System 4590 – Crank Operated

Price category C

### Price Group 1R - Puma

Width	80cm	100cm	120cm	140cm	Width
Drop cm					Drop cm
80	1018.82	1103.47	1188.19	1272.87	80
100	1072.63	1158.76	1244.93	1331.09	100
120	1126.48	1214.06	1301.69	1389.28	120
140	1180.29	1269.38	1358.45	1447.49	140
160	1234.19	1324.65	1415.20	1505.69	160
180	1288.00	1379.93	1471.91	1563.90	180

### Price Group 2R - Mercurio B

Width	80cm	100cm	120cm	140cm	Width
Drop cm					Drop cm
80	1033.18	1121.47	1209.77	1298.04	80
100	1090.62	1181.26	1271.92	1362.60	100
120	1148.07	1241.07	1334.06	1427.08	120
140	1205.48	1300.87	1396.21	1491.57	140
160	1262.97	1360.64	1458.39	1556.07	160
180	1320.38	1420.42	1520.52	1620.57	180

### Price Group 3R - Moon or Twin Blackout

Width	80cm	100cm	120cm	140cm	Width
Drop cm					Drop cm
80	1064.06	1160.06	1256.09	1352.10	80
100	1129.20	1229.50	1329.83	1430.12	100
120	1194.36	1298.97	1403.55	1508.12	120
140	1259.51	1368.40	1477.28	1586.14	140
160	1324.71	1437.83	1551.00	1664.15	160
180	1389.87	1507.28	1624.71	1742.15	180

White or black hardware available as standard. For special colours refer to page 54.

## System 4595 – Electrically Operated

Price category C

### Price Group 1R - Puma

Width	80cm	100cm	120cm	140cm	Width
Drop cm					Drop cm
80	1324.76	1407.76	1490.81	1573.74	80
100	1378.85	1463.25	1547.66	1632.05	100
120	1432.95	1518.72	1604.52	1690.33	120
140	1487.00	1574.29	1661.44	1748.59	140
160	1541.10	1629.71	1718.30	1806.92	160
180	1595.19	1685.18	1775.19	1865.22	180

### Price Group 2R - Mercurio B

Width	80cm	100cm	120cm	140cm	Width
Drop cm					Drop cm
80	1371.12	1457.03	1543.00	1628.82	80
100	1427.11	1514.47	1601.83	1689.17	100
120	1483.11	1571.86	1660.70	1749.50	120
140	1539.04	1629.39	1719.59	1809.78	140
160	1595.04	1686.73	1778.45	1870.17	160
180	1651.03	1744.18	1837.33	1930.50	180

### Price Group 3R - Moon or Twin Blackout

Width	80cm	100cm	120cm	140cm	Width
Drop cm					Drop cm
80	1416.40	1513.61	1610.90	1708.06	80
100	1483.68	1585.19	1686.71	1788.19	100
120	1551.01	1656.75	1762.53	1868.33	120
140	1618.26	1728.41	1838.42	1948.41	140
160	1685.57	1799.91	1914.26	2028.61	160
180	1752.88	1871.48	1990.10	2108.75	180

White or black hardware available as standard. For special colours refer to page 53.

NOTE: Our Skylight Roller blind systems are supplied ready assembled in an 80mm x 20mm aluminium framework for easy fitting. Integrated Receiver for use with 9940 add £164.31

All prices shown exclude VAT



# Venetian Blinds

## Venetian Blind Slat Information

### Aluminium Slats

#### Price Group 1

Slat Reference	Slat Width (mm)	Slat Description
603	16	Natural Alu
612	16	Off White
613	16	Clear White
615	16	White

Slat Reference	Slat Width (mm)	Slat Description
648	16	Light Grey
649	16	Light Grey
650	16	Magnolia
706	25	Natural Alu

Slat Reference	Slat Width (mm)	Slat Description
716	25	Off White
718	25	Clear White
720	25	White
758	25	Light Grey

Slat Reference	Slat Width (mm)	Slat Description
759	25	Light Grey
761	25	Magnolia

#### Price Group 2

Slat Reference	Slat Width (mm)	Slat Description
601	16	Polished Alu
602	16	TRP Natural Silver
604	16	Bright Silver
609	16	Natural Silver
610	16	Natural Silver Matt
611	16	Light Ash
614	16	Pearl China White
616	16	Light Grey
617	16	Grey Flannel
618	16	Metal Grey

Slat Reference	Slat Width (mm)	Slat Description
619	16	Gloss Black
620	16	Black
624	16	Turkey Blue
651	16	Magnolia
657	16	Fire Dragon
658	16	Glossy Red
659	16	Spectrum Red
660	16	Garnet Red
703	25	Polished Alu
704	25	TRP Natural Silver

Slat Reference	Slat Width (mm)	Slat Description
705	25	Alu Perforated
707	25	Bright Silver
712	25	Natural Silver
713	25	Natural Silver Matt
714	25	Light Ash
715	25	White Perforated
719	25	Pearl China White
723	25	Light Grey
724	25	Grey Flannel
725	25	Metal Grey

Slat Reference	Slat Width (mm)	Slat Description
726	25	Gloss Black
729	25	Black
733	25	Turkey Blue
760	25	Magnolia Perforated
762	25	Magnolia
770	25	Fire Dragon
771	25	Glossy Red
772	25	Spectrum Red
773	25	Garnet Red

#### Price Group 3

Slat Reference	Slat Width (mm)	Slat Description
605	16	Bright Gold
606	16	Caribou
607	16	Bright Bronze
608	16	Aluminium Gris
621	16	Black Tie
622	16	Indigo
623	16	Admiral
625	16	Mount Baker
626	16	Morning Glory
627	16	Universe Blue
628	16	Pearl Gulf Blue
629	16	Fishing Blue
630	16	Greek Holiday
631	16	Light Laguna
632	16	Pearl Jade
633	16	Riverbend
634	16	Green Mint
635	16	Hunter Green
636	16	Chameleon Green
637	16	Green Aspen
638	16	Weeping Green
639	16	Grass Snake

Slat Reference	Slat Width (mm)	Slat Description
640	16	Absinthe
641	16	Aztec
642	16	Saffron
643	16	Naples Cream
644	16	Daffodil
645	16	Maize Yellow
646	16	Light Banana
647	16	Beaverwood
652	16	Fawn
653	16	Spun Gold
654	16	US Beige
655	16	Mud Pie
656	16	Dark Beige
661	16	EL Morocco
701	25	Foil Mirror Silver
702	25	Alu Perforated
708	25	Bright Gold
709	25	Caribou
710	25	Bright Bronze
711	25	Aluminium Gris
717	25	Off White
721	25	White

Slat Reference	Slat Width (mm)	Slat Description
722	25	Grey Perforated
727	25	Black Perforated
728	25	Black
730	25	Black Tie
731	25	Indigo
732	25	Admiral
734	25	Mount Baker
735	25	Morning Glory
736	25	Universe Blue
737	25	Pearl Gulf Blue
738	25	Fishing Blue
739	25	Greek Holiday
740	25	Light Laguna
741	25	Emerald Ice
742	25	Pearl Jade
743	25	Riverbend
744	25	Green Mint
745	25	Hunter Green
746	25	Chameleon Green
747	25	Green Aspen
748	25	Weeping Green
749	25	Grass Snake

Slat Reference	Slat Width (mm)	Slat Description
750	25	Absinthe
751	25	Aztec
752	25	Saffron
753	25	Naples Cream
754	25	Daffodil
755	25	Maize Yellow
756	25	Light Banana
757	25	Beaverwood
763	25	Fawn
764	25	Fawn
765	25	Spun Gold
766	25	US Beige
767	25	Mud Pie
768	25	Dark Beige
769	25	Diamond Mine
774	25	EL Morocco
775	25	Woodgrain Beech
776	25	Woodgrain Dark Oak
777	25	Woodgrain Abbey



# Venetian Blinds

## System 8110 (16mm)

Mono control Venetian Blind System.  
 Slats 16mm.  
 Maximum System Width: 2.5m  
 Minimum System Width: 28cm  
 Maximum System Drop: 2.5m  
 Maximum Surface Area: 5m<sup>2</sup>

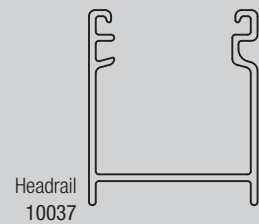
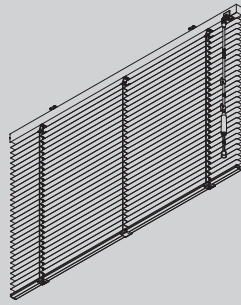

The prices in the tables below comprise the complete system made-to-measure with 16mm slats ready to hang. If sizes lie between the measurements shown, the price for the next size larger will apply. White control wands as standard (other colours available). The following wand sizes are available 225mm, 385mm, 585mm, 785mm, 985mm, 1185mm, 1385mm, 1585mm and 1800mm. For side guided version please add 20% to prices below.

### Price Group 1

Price Category C

Width Drop cm	60cm	80cm	100cm	120cm	140cm	160cm	180cm	200cm	220cm	240cm	250cm	Width Drop cm
60	144.57	157.99	171.43	184.88	198.32	211.76	225.20	238.64	252.08	265.55	272.24	60
80	148.88	163.72	178.56	193.39	208.24	223.07	237.91	252.74	267.56	282.42	289.82	80
100	153.20	169.43	185.66	201.92	218.13	234.36	250.59	266.83	283.06	299.29	307.41	100
120	157.53	175.15	192.78	210.41	228.04	245.68	263.30	280.92	298.54	316.17	325.00	120
140	161.84	180.86	199.88	218.89	237.93	256.96	275.98	295.02	314.02	333.07	342.58	140
160	166.16	186.56	207.00	227.40	247.83	268.25	288.68	309.11	329.53	349.94	360.16	160
180	170.47	192.30	214.11	235.91	257.73	279.56	301.37	323.18	345.01	366.83	377.72	180
200	174.77	198.01	221.21	244.43	267.66	290.86	314.08	337.28	360.50	383.71	395.31	200
220	179.11	203.71	228.30	252.93	277.54	302.16	326.78	351.37	375.99			220
240	183.42	209.42	235.45	261.42	287.46	313.45	339.45	365.46				240
260	185.59	212.28	238.99	265.68	292.40	319.11	345.80	372.51				260

### Price Group 2

Price Category C

Width Drop cm	60cm	80cm	100cm	120cm	140cm	160cm	180cm	200cm	220cm	240cm	250cm	Width Drop cm
60	149.32	164.34	183.14	194.40	209.41	224.45	239.46	254.48	269.52	284.54	292.05	60
80	155.22	172.17	189.11	206.05	223.02	239.97	256.91	273.86	290.82	307.76	316.25	80
100	161.12	179.99	198.88	217.74	236.62	255.51	274.35	293.24	312.10	330.98	340.42	100
120	167.02	187.81	208.64	229.41	250.20	271.03	291.81	312.60	333.41	354.21	364.60	120
140	172.92	195.65	218.38	241.09	263.81	286.53	309.26	331.96	354.69	377.41	388.79	140
160	178.82	203.48	228.12	252.76	277.41	302.05	326.71	351.35	376.01	400.65	412.95	160
180	184.74	211.30	237.88	264.43	291.00	317.59	344.15	370.71	397.29	423.87	437.16	180
200	190.63	219.14	247.62	276.11	304.61	333.10	361.60	390.10	418.59	447.08	461.35	200
220	196.54	226.95	257.38	287.81	318.20	348.63	379.06	409.47	439.89			220
240	202.42	234.77	267.11	299.47	331.81	364.14	396.50	428.82				240
260	205.37	238.68	271.99	305.30	338.61	371.90	405.22	438.52				260

### Price Group 3

Price Category C

Width Drop cm	60cm	80cm	100cm	120cm	140cm	160cm	180cm	200cm	220cm	240cm	250cm	Width Drop cm
60	160.65	177.38	194.10	210.83	227.55	244.27	260.98	277.70	294.43	311.16	319.52	60
80	167.72	186.74	205.75	224.79	243.81	262.85	281.85	300.89	319.91	338.94	348.44	80
100	174.75	196.10	217.42	238.75	260.09	281.42	302.74	324.07	345.40	366.73	377.39	100
120	181.80	205.44	229.07	252.72	276.35	299.99	323.62	347.26	370.90	394.53	406.35	120
140	188.87	214.81	240.74	266.67	292.62	318.56	344.51	370.45	396.39	422.32	435.29	140
160	195.90	224.18	252.39	280.64	308.90	337.13	365.39	393.62	421.86	450.11	464.24	160
180	202.95	233.51	264.05	294.61	325.14	355.70	386.24	416.80	447.35	477.91	493.19	180
200	210.00	242.87	275.72	308.57	341.43	374.27	407.15	439.99	472.85	505.70	522.13	200
220	217.06	252.23	287.37	322.54	357.70	392.85	428.01	463.18	498.34			220
240	215.29	261.60	299.06	336.51	373.98	411.43	448.89	486.35				240
260	227.64	266.25	304.88	343.48	382.11	420.71	459.33	497.93				260

All prices shown exclude VAT



# Venetian Blinds

## System 8110PC (25mm)

Mono control Venetian Blind System.  
 Slats 25mm.  
 Maximum System Width: 3m  
 Minimum System Width: 28cm  
 Maximum System Drop: 5m  
 Maximum Surface Area: 7m<sup>2</sup>

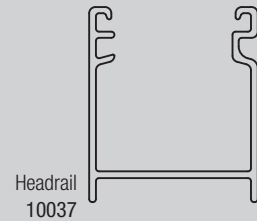
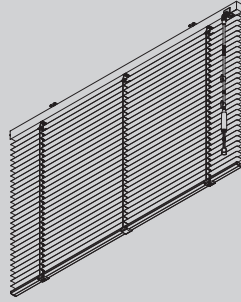

The prices in the tables below comprise the complete system made-to-measure with 25mm slats ready to hang. If sizes lie between the measurements shown, the price for the next size larger will apply. White control wands as standard (other colours available). The following wand sizes are available 225mm, 385mm, 585mm, 785mm, 985mm, 1185mm, 1385mm, 1585mm and 1800mm. For side guided version please add 20% to prices below.

### Price Group 1

### Price Category C

Width Drop cm	60cm	80cm	100cm	120cm	140cm	160cm	180cm	200cm	220cm	240cm	260cm	280cm	300cm	Width Drop cm
60	146.57	160.60	174.64	188.65	202.67	216.69	230.72	244.76	258.76	272.80	286.83	300.86	314.87	60
80	151.10	166.54	182.00	197.43	212.87	228.31	243.77	259.20	274.66	290.10	305.56	321.03	336.45	80
100	155.61	172.48	189.35	206.23	223.09	239.97	256.82	273.68	290.55	307.42	324.28	341.16	358.03	100
120	160.13	178.41	196.71	215.00	233.30	251.57	269.88	288.16	306.44	324.71	343.01	361.31	379.61	120
140	164.64	184.37	204.07	223.79	243.51	263.19	282.91	302.63	322.33	342.05	361.75	381.48	401.16	140
160	169.18	190.30	211.43	232.55	253.70	274.83	295.95	317.10	338.24	359.35	380.48	401.60	422.75	160
180	173.71	196.25	218.80	241.36	263.90	286.44	309.02	331.55	354.12	376.69	399.21	421.77	444.31	180
200	178.23	202.19	226.16	250.13	274.12	298.08	322.06	346.03	370.00	393.98	417.94	441.93	465.89	200
220	182.73	208.11	233.52	258.92	284.31	309.71	335.09	360.50	385.89	411.29	436.67	462.06	487.46	220
240	187.25	214.07	240.89	267.71	294.51	321.32	348.14	374.97	401.77	428.61	455.40	482.22	509.04	240
260	191.77	220.02	248.25	276.50	304.73	332.94	361.21	389.43	417.67	445.90	474.12	502.38		260
280	196.29	225.96	255.61	285.29	314.93	344.57	374.23	403.88	433.57	463.21	492.86			280
300	200.81	231.89	262.97	294.04	325.11	356.21	387.30	418.36	449.45	480.52				300
320	205.34	237.86	270.34	302.82	335.34	367.84	400.33	432.82	465.34					320
340	209.87	243.77	277.70	311.63	345.54	379.46	413.36	447.31						340
360	214.40	249.72	285.06	320.40	355.73	391.09	426.43	461.77						360
380	218.89	255.65	292.43	329.20	365.95	402.70	439.48							380
400	223.42	261.62	299.76	337.96	376.14	414.33	452.52							400
420	227.93	267.53	307.14	346.77	386.35	425.95								420
440	232.47	273.49	314.52	355.54	396.56	437.59								440
460	236.97	279.42	321.88	364.32	406.77									460
480	241.51	285.38	329.24	373.11	416.97									480
500	246.06	291.31	336.61	381.89	427.18									500

### Price Group 2

### Price Category C

Width Drop cm	60cm	80cm	100cm	120cm	140cm	160cm	180cm	200cm	220cm	240cm	260cm	280cm	300cm	Width Drop cm
60	151.47	167.12	182.81	198.45	214.11	229.77	245.43	261.07	276.74	292.40	308.06	323.72	339.36	60
80	157.62	175.25	192.86	210.50	228.12	245.75	263.37	280.99	298.61	316.25	333.87	351.49	369.12	80
100	163.77	183.37	202.95	222.54	242.14	261.72	281.31	300.89	320.46	340.08	359.66	379.24	398.83	100
120	169.93	191.49	213.03	234.59	256.16	277.70	299.24	320.80	342.36	363.92	385.48	407.02	428.59	120
140	176.09	199.61	223.11	246.63	270.17	293.67	317.18	340.71	364.23	387.75	411.27	434.79	458.31	140
160	182.23	207.72	233.22	258.69	284.17	309.67	335.15	360.62	386.12	411.61	437.07	462.56	488.06	160
180	188.38	215.83	243.29	270.74	298.18	325.64	353.07	380.53	408.00	435.44	462.88	490.33	517.79	180
200	194.55	223.95	253.39	282.80	312.20	341.63	371.04	400.46	429.87	446.92	488.70	518.11	547.52	200
220	200.70	232.08	263.46	294.83	326.20	357.60	388.98	420.36	451.74	483.12	514.49	545.87	577.26	220
240	206.86	240.19	273.54	306.90	340.22	373.59	406.92	440.28	473.60	506.98	540.31	573.66	607.01	240
260	213.00	248.33	283.63	318.94	354.24	389.56	424.86	460.18	495.48	530.80	566.11	601.42		260
280	219.17	256.43	293.71	330.99	368.26	405.55	442.82	480.10	517.36	554.63	591.91			280
300	225.31	264.55	303.79	343.02	382.26	421.50	460.75	499.99	539.24	578.48				300
320	231.47	272.67	313.89	355.10	396.28	437.47	478.70	519.91	561.10					320
340	237.60	280.78	323.96	367.13	410.30	453.46	496.65	539.82						340
360	243.76	288.91	334.04	379.17	424.32	469.43	514.58	559.71						360
380	249.92	297.01	344.13	391.24	438.33	485.44	532.54							380
400	256.06	305.15	354.21	403.27	452.35	501.41	550.46							400
420	262.23	313.26	364.30	415.34	466.36	517.39								420
440	268.38	321.38	374.37	427.35	480.38	533.37								440
460	274.54	329.50	384.46	439.43	494.38									460
480	280.68	337.61	394.54	451.47	508.39									480
500	286.84	345.74	404.63	463.52	522.42									500

All prices shown exclude VAT



# Venetian Blinds

## System 8110PC (25mm)

Mono control Venetian Blind System.  
 Slats 25mm.  
 Maximum System Width: 3m  
 Minimum System Width: 28cm  
 Maximum System Drop: 5m  
 Maximum Surface Area: 7m<sup>2</sup>

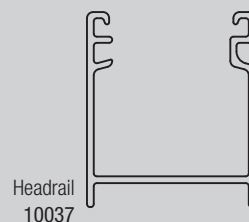
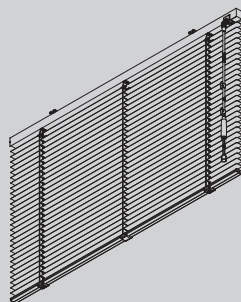

The prices in the table below comprise the complete system made-to-measure with 25mm slats ready to hang. If sizes lie between the measurements shown, the price for the next size larger will apply. White control wands as standard (other colours available). The following wand sizes are available 225mm, 385mm, 585mm, 785mm, 985mm, 1185mm, 1385mm, 1585mm and 1800mm. For side guided version please add 20% to prices below.

### Price Group 3 – 25mm slat size

Price Category C

Width Drop cm	60cm	80cm	100cm	120cm	140cm	160cm	180cm	200cm	220cm	240cm	260cm	280cm	300cm	Width Drop cm
60	165.44	185.72	206.04	226.37	246.67	266.97	287.29	307.62	327.94	348.23	368.54	388.86	409.16	60
80	176.23	200.06	223.89	247.71	271.53	295.38	319.19	343.02	366.85	390.66	414.51	438.34	462.17	80
100	187.04	214.40	241.74	269.07	296.44	323.77	351.11	378.44	405.79	433.14	460.48	487.82	515.16	100
120	197.84	228.70	259.56	290.42	321.29	352.15	383.01	413.87	444.74	475.60	506.44	537.32	568.18	120
140	208.67	243.04	277.41	311.78	346.15	380.53	414.93	449.30	483.68	518.03	552.42	586.78	621.17	140
160	219.46	257.37	295.25	333.15	371.04	408.93	446.81	484.70	522.60	560.49	598.40	636.28	674.17	160
180	230.28	271.68	313.10	354.49	395.90	437.31	478.72	520.12	561.53	602.94	644.35	685.77	727.17	180
200	241.06	286.00	330.93	375.84	420.78	465.70	510.63	555.57	600.46	645.39	690.33	735.24	780.18	200
220	251.88	300.33	348.76	397.20	445.66	494.11	542.51	590.96	639.40	687.86	736.29	784.74	833.18	220
240	262.68	314.65	366.62	418.56	470.51	522.47	574.43	626.40	678.34	730.30	782.25	834.24	886.17	240
260	273.49	328.97	384.43	439.93	495.39	550.85	606.33	661.80	717.29	772.76	828.23	883.70		260
280	284.30	343.28	402.28	461.27	520.26	579.25	638.23	697.22	756.22	815.21	874.20			280
300	295.11	357.61	420.12	482.62	545.20	607.62	670.14	732.65	795.14	857.67				300
320	305.91	371.92	437.96	503.98	570.00	636.01	702.06	768.08	834.08					320
340	316.72	386.24	455.78	525.34	594.88	664.40	733.94	803.48						340
360	327.53	400.59	473.63	546.68	619.76	692.80	765.86	838.91						360
380	338.33	414.91	491.47	568.05	644.61	721.18	797.75							380
400	349.14	429.23	509.31	589.41	669.48	749.56	829.67							400
420	359.94	443.54	527.15	610.76	694.35	777.96								420
440	370.73	457.88	544.98	632.09	719.24	806.34								440
460	381.55	472.20	562.83	653.47	744.08									460
480	392.35	486.53	580.66	674.82	768.96									480
500	403.17	500.83	598.50	696.18	793.85									500

All prices shown exclude VAT



# Venetian Blinds

## System 8250 (16mm)

Electrically operated Venetian Blind System.

System with 24v motor 8060.

Maximum System Width: 300cm

Minimum System Width: 65cm\*

Maximum System Drop: 340cm

Maximum Surface Area: 5m<sup>2</sup>

\* Please refer to Catalogue pages

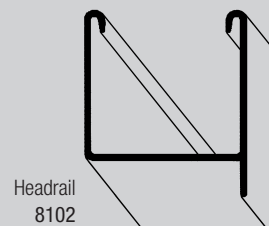
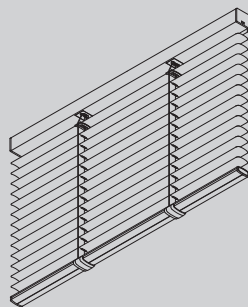

The prices in the tables below and on the following page comprise the complete system made-to-measure with 16mm and 25mm slats ready to hang with universal snap bracket 8201. If sizes lie between the measurements shown, the price for the next size larger will apply. For multicoloured blinds add 20% to prices below for each colour. For side-guided/sloping version add 20% to prices below.

### Price Group 1

### Price Category C

Width Drop cm	80cm	100cm	120cm	140cm	160cm	180cm	200cm	220cm	240cm	260cm	280cm	300cm	Width Drop cm
60	582.90	610.84	638.76	666.68	694.64	722.55	750.47	778.41	806.34	834.28	862.19	890.13	60
80	589.49	618.88	648.21	677.60	706.97	736.30	765.67	795.05	824.38	853.78	883.12	912.49	80
100	596.09	626.89	657.66	688.49	719.27	750.07	780.90	811.66	842.48	873.25	904.05	934.86	100
120	602.67	634.88	667.12	699.37	731.59	763.84	796.06	828.27	860.53	892.73	924.97	957.22	120
140	609.26	642.89	676.60	710.25	743.91	777.56	811.24	844.94	878.59	912.23	945.91	979.57	140
160	615.87	650.96	686.01	721.14	756.26	791.35	826.43	861.54	896.64	931.75	966.84	1001.93	160
180	622.41	658.97	695.49	732.05	768.57	805.09	841.63	878.18	914.72	951.25			180
200	629.02	666.99	704.95	742.94	780.91	818.86	856.82	894.81	932.78				200
220	635.59	674.99	714.43	753.80	793.22	832.61	872.00	911.41					220
240	642.19	683.05	723.86	764.68	805.51	846.39	887.24						240
260	648.77	691.05	733.31	775.60	817.86	860.14							260
280	655.37	699.07	742.77	786.46	830.18								280
300	661.95	707.10	752.22	797.36	842.53								300
320	668.51	715.11	761.67	808.25									320
340	675.13	723.11	771.12	819.17									340

### Price Group 2

### Price Category C

Width Drop cm	80cm	100cm	120cm	140cm	160cm	180cm	200cm	220cm	240cm	260cm	280cm	300cm	Width Drop cm
60	592.12	622.31	652.54	682.77	712.98	743.20	773.43	803.68	833.89	864.09	894.31	924.54	60
80	599.83	631.77	663.71	695.66	727.62	759.55	791.50	823.44	855.37	887.33	919.25	951.22	80
100	607.56	641.26	674.89	708.58	742.22	775.88	809.57	843.21	876.89	910.55	944.20	977.91	100
120	615.30	650.67	686.05	721.47	756.85	792.23	827.60	862.97	898.38	933.78	969.14	1004.56	120
140	623.04	660.14	697.23	734.34	771.42	808.54	845.68	882.81	919.92	956.99	994.11	1031.22	140
160	630.75	669.59	708.40	747.26	786.07	824.90	863.74	902.57	941.41	980.23	1019.05	1057.88	160
180	638.48	679.05	719.61	760.16	800.70	841.24	881.79	922.33	962.92	1003.44			180
200	646.23	688.50	730.78	773.04	815.31	857.58	899.84	942.11	984.42				200
220	653.96	697.95	741.93	785.96	829.92	873.93	917.92	961.94					220
240	661.70	707.42	753.12	798.84	844.55	890.26	935.99						240
260	669.45	716.87	764.28	811.76	859.16	906.61							260
280	677.18	726.34	775.52	824.65	873.80								280
300	684.90	735.77	786.68	837.52	888.42								300
320	692.64	745.26	797.81	850.42									320
340	700.37	754.70	809.00	863.34									340

### Price Group 3

### Price Category C

Width Drop cm	80cm	100cm	120cm	140cm	160cm	180cm	200cm	220cm	240cm	260cm	280cm	300cm	Width Drop cm
60	615.81	647.21	678.64	710.08	741.50	772.94	804.35	835.84	867.23	898.67	930.08	961.53	60
80	623.82	657.04	690.24	723.49	756.72	789.96	823.14	856.37	889.60	922.83	956.05	989.28	80
100	631.89	666.91	701.88	736.92	771.92	806.90	841.94	876.93	911.97	946.96	981.97	1017.02	100
120	639.91	676.71	713.49	750.32	787.13	823.90	860.72	897.50	934.32	971.12	1007.90	1044.74	120
140	647.94	686.55	725.13	763.73	802.31	840.89	879.51	918.11	956.70	995.25	1033.87	1072.47	140
160	656.00	696.39	736.74	777.15	817.54	857.89	898.31	938.66	979.06	1019.45	1059.83	1100.20	160
180	664.02	706.20	748.37	790.55	832.74	874.91	917.07	959.24	1001.43	1043.58			180
200	672.07	716.02	760.02	803.97	847.95	891.89	935.83	979.80	1023.79				200
220	680.12	725.85	771.62	817.37	863.13	908.88	954.62	1000.41					220
240	688.18	735.72	783.26	830.81	878.35	925.87	973.43						240
260	696.21	745.52	794.86	844.20	893.53	942.87							260
280	704.28	755.38	806.52	857.62	908.73								280
300	712.31	765.19	818.13	871.05	923.94								300
320	720.34	775.05	829.72	884.43									320
340	728.39	784.89	841.37	897.90									340

Supplied with standard rocker switch. Programmable rocker switch (0937) available as an optional accessory.

All prices shown exclude VAT





# Venetian Blinds

## System 8250 (25mm)

Electrically operated Venetian Blind System.

System with 24v motor 8060.

Maximum System Width: 300cm

Minimum System Width: 65cm\*

Maximum System Drop: 340cm

Maximum Surface Area: 5m<sup>2</sup>

\* Please refer to Catalogue pages

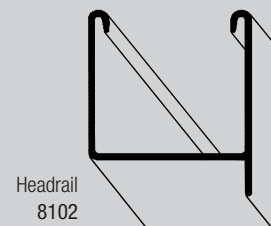
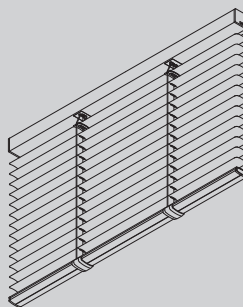

### Price Group 1

### Price Category C

Width Drop cm	80cm	100cm	120cm	140cm	160cm	180cm	200cm	220cm	240cm	260cm	280cm	300cm	Width Drop cm
60	572.17	597.77	623.39	649.04	674.61	700.23	725.87	751.49	777.12	802.73	828.33	853.97	60
80	577.16	603.90	630.61	657.34	684.08	710.82	737.55	764.28	791.03	817.76	844.50	871.20	80
100	582.13	610.00	637.86	665.68	693.56	721.40	749.25	777.11	804.92	832.81	860.61	888.52	100
120	587.14	616.11	645.08	674.05	703.00	731.98	760.92	789.92	818.86	847.81	876.80	905.77	120
140	592.16	622.21	652.29	682.37	712.45	742.53	772.61	802.71	832.79	862.86	892.96	923.01	140
160	597.12	628.33	659.52	690.74	721.92	753.11	784.29	815.49	846.71	877.89	909.08	940.29	160
180	602.12	634.43	666.73	699.07	731.38	763.70	795.99	828.28	860.60	892.93			180
200	607.10	640.56	674.00	707.41	740.85	774.26	807.65	841.10	874.52				200
220	612.11	646.67	681.21	715.74	750.29	784.83	819.36	853.90					220
240	617.07	652.75	688.43	724.10	759.74	795.41	831.03						240
260	622.08	658.89	695.66	732.42	769.20	805.98							260
280	627.07	665.01	702.88	740.78	778.66								280
300	632.09	671.10	710.12	749.12	788.11								300
320	637.10	677.23	717.32	757.44									320
340	642.06	683.32	724.54	765.82									340

### Price Group 2

### Price Category C

Width Drop cm	80cm	100cm	120cm	140cm	160cm	180cm	200cm	220cm	240cm	260cm	280cm	300cm	Width Drop cm
60	579.30	606.69	634.10	661.53	688.92	716.30	743.73	771.11	798.54	825.93	853.32	880.73	60
80	585.19	613.95	642.64	671.44	700.15	728.89	757.64	786.39	815.12	843.85	872.62	901.34	80
100	591.08	621.15	651.23	681.30	711.38	741.48	771.58	801.61	831.73	861.80	891.87	921.93	100
120	596.97	628.39	659.79	691.22	722.64	754.06	785.47	816.90	848.35	879.74	911.16	942.59	120
140	602.85	635.59	668.39	701.11	733.88	766.64	799.40	832.15	864.91	897.67	930.44	963.20	140
160	608.74	642.83	676.92	711.02	745.12	779.21	813.33	847.39	881.51	915.61	949.70	983.80	160
180	614.62	650.04	685.47	720.94	756.35	791.81	827.23	862.66	898.11	933.52			180
200	620.50	657.28	694.02	730.83	767.62	804.37	841.12	877.93	914.71				200
220	626.38	664.50	702.61	740.73	778.83	816.96	855.09	893.18					220
240	632.27	671.70	711.19	750.65	790.05	829.54	868.98						240
260	638.17	678.93	719.74	760.55	801.32	842.09							260
280	644.05	686.22	728.31	770.46	812.55								280
300	649.95	693.41	736.89	780.32	823.82								300
320	655.81	700.65	745.44	790.27									320
340	661.71	707.84	753.99	800.15									340

### Price Group 3

### Price Category C

Width Drop cm	80cm	100cm	120cm	140cm	160cm	180cm	200cm	220cm	240cm	260cm	280cm	300cm	Width Drop cm
60	593.57	624.57	655.54	686.52	717.48	748.45	779.39	810.36	841.38	872.34	903.32	934.29	60
80	601.24	634.00	666.74	699.53	732.29	765.05	797.79	830.56	863.33	896.10	928.85	961.59	80
100	608.92	643.46	678.01	712.55	747.09	781.65	816.20	850.71	885.22	919.84	954.33	988.89	100
120	616.58	652.95	689.25	725.58	761.91	798.26	834.56	870.87	907.18	943.56	979.88	1016.21	120
140	624.27	662.39	700.48	738.58	776.72	814.83	852.95	891.06	929.19	967.27	1005.38	1043.51	140
160	631.95	671.85	711.72	751.64	791.53	831.40	871.35	911.23	951.12	990.99	1030.93	1070.81	160
180	639.62	681.29	722.97	764.65	806.34	848.03	889.71	931.39	973.08	1014.73			180
200	647.26	690.76	734.22	777.68	821.16	864.61	908.07	951.55					200
220	654.94	700.21	745.45	790.69	835.98	881.22	926.47	971.70					220
240	662.61	709.66	756.69	803.74	850.75	897.82	944.86						240
260	670.31	719.11	767.95	816.74	865.60	914.41							260
280	677.96	728.57	779.18	829.77	880.39								280
300	685.65	738.02	790.41	842.81	895.21								300
320	693.28	747.47	801.66	855.86									320
340	700.98	756.95	812.87	868.88									340

All prices shown exclude VAT



# Venetian Blinds

## System 8300 (16mm)

Mono control Venetian Blind System.  
 Slats 16mm.  
 Maximum System Width: 3m  
 Minimum System Width: 50cm  
 Maximum System Drop: 3m  
 Maximum Surface Area: 4.5m<sup>2</sup>

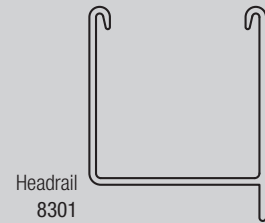
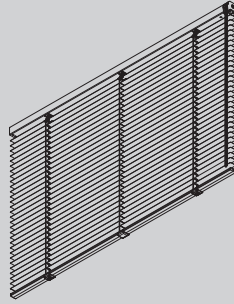

The prices in the tables below comprise the complete system made-to-measure with 16mm slats ready to hang. If sizes lie between the measurements shown, the price for the next size larger will apply. For side-guide or sloping add 20%.

### Price Group 1

Price Category C

Width Drop cm	60cm	80cm	100cm	120cm	140cm	160cm	180cm	200cm	220cm	240cm	260cm	280cm	300cm	Width Drop cm
60	149.84	164.70	179.57	194.45	209.34	224.21	239.07	253.97	268.82	283.69	298.58	313.45	328.34	60
80	154.15	170.47	186.78	203.10	219.42	235.74	252.04	268.38	284.70	301.00	317.33	333.64	349.95	80
100	158.47	176.23	194.01	211.76	229.51	247.28	265.04	282.81	300.55	318.30	336.07	353.84	371.58	100
120	162.80	182.03	201.20	220.42	239.62	258.81	278.02	297.23	316.42	335.62	354.83	374.03	393.23	120
140	167.12	187.78	208.41	229.07	249.71	270.35	291.00	311.64	332.28	352.95	373.59	394.22	414.86	140
160	171.47	193.56	215.64	237.71	259.82	281.89	303.99	326.07	348.14	370.25	392.32	414.40	436.49	160
180	175.78	199.32	222.84	246.36	269.91	293.43	316.95	340.49	364.01	387.54	411.08			180
200	180.12	205.10	230.04	255.02	279.99	304.96	329.94	354.90	379.87	404.84				200
220	184.43	210.87	237.27	263.70	290.09	316.50	342.92	369.34	395.76					220
240	188.76	216.63	244.47	272.34	300.20	328.03	355.92	383.75						240
260	193.11	222.40	251.69	280.99	310.29	339.58	368.89							260
280	197.43	228.17	258.91	289.64	320.38	351.13								280
300	201.76	233.94	266.11	298.31	330.49	362.67								300

### Price Group 2

Price Category C

Width Drop cm	60cm	80cm	100cm	120cm	140cm	160cm	180cm	200cm	220cm	240cm	260cm	280cm	300cm	Width Drop cm
60	154.57	171.03	187.51	203.96	220.42	236.86	253.33	269.80	286.26	302.72	319.17	335.64	352.10	60
80	160.49	178.92	197.35	215.79	234.21	252.65	271.08	289.49	307.93	326.37	344.78	363.22	381.64	80
100	166.40	186.81	207.21	227.60	248.01	268.40	288.78	309.20	329.61	349.99	370.39	390.81	411.19	100
120	172.32	194.68	217.05	239.43	261.78	284.15	306.54	328.90	351.26	373.65	396.01	418.38	440.76	120
140	178.24	202.58	226.91	251.24	275.59	299.93	324.27	348.62	372.95	397.29	421.63	445.97	470.34	140
160	184.14	210.45	236.76	263.08	289.38	315.67	342.00	368.31	394.62	420.92	447.26	473.55	499.87	160
180	190.05	218.34	246.60	274.90	303.16	331.45	359.73	388.01	416.29	444.60	472.86			180
200	195.94	226.20	256.46	286.72	316.97	347.22	377.49	407.72	437.97	468.23				200
220	201.86	234.08	266.32	298.53	330.76	362.97	395.20	427.44	459.66					220
240	207.80	241.96	276.17	310.35	344.55	378.75	412.92	447.12						240
260	213.69	249.85	286.01	322.18	358.34	394.50	430.67							260
280	219.61	257.73	295.85	334.01	372.13	410.27								280
300	225.51	265.62	305.72	345.84	385.92	426.05								300

### Price Group 3

Price Category C

Width Drop cm	60cm	80cm	100cm	120cm	140cm	160cm	180cm	200cm	220cm	240cm	260cm	280cm	300cm	Width Drop cm
60	166.24	184.49	202.71	220.95	239.21	257.44	275.69	293.93	312.15	330.41	348.66	366.88	385.14	60
80	173.31	193.89	214.48	235.10	255.66	276.28	296.89	317.46	338.06	358.65	379.24	399.85	420.45	80
100	180.36	203.31	226.28	249.21	272.16	295.11	318.06	341.00	363.95	386.90	409.86	432.78	455.74	100
120	187.43	212.72	238.01	263.33	288.63	313.93	339.26	364.53	389.83	415.13	440.44	465.76	491.04	120
140	194.48	222.12	249.80	277.46	305.11	332.78	360.41	388.06	415.74	443.39	471.03	498.70	526.35	140
160	201.55	231.56	261.59	291.56	321.57	351.58	381.58	411.62	441.62	471.63	501.64	531.65	561.66	160
180	208.62	240.96	273.33	305.70	338.06	370.41	402.78	435.14	467.49	499.87	532.22			180
200	215.67	250.38	285.10	319.82	354.53	389.24	423.96	458.69	493.40	528.12				200
220	222.73	259.81	296.88	333.94	371.01	408.07	445.15	482.21	519.29					220
240	229.79	269.21	308.62	348.06	387.47	426.90	466.33	505.73						240
260	236.84	278.62	320.39	362.17	403.95	445.73	487.49							260
280	243.92	288.05	332.18	376.31	420.44	464.57								280
300	250.97	297.44	343.94	390.43	436.91	483.38								300

Child safety device (10482) – add on £8.83.

All prices shown exclude VAT



# Venetian Blinds

## System 8300 (25mm)

Mono control Venetian Blind System.  
 Slats 25mm.  
 Maximum System Width: 3m  
 Minimum System Width: 50cm  
 Maximum System Drop: 3m  
 Maximum Surface Area: 4.5m<sup>2</sup>

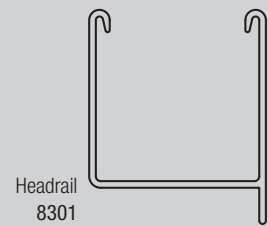
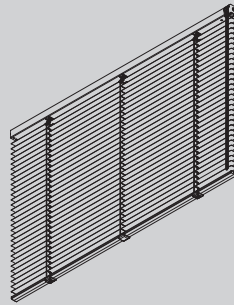

The prices in the tables below comprise the complete system made-to-measure with 25mm slats ready to hang. If sizes lie between the measurements shown, the price for the next size larger will apply. For side-guide or sloping add 20%.

### Price Group 1

### Price Category C

Width Drop cm	60cm	80cm	100cm	120cm	140cm	160cm	180cm	200cm	220cm	240cm	260cm	280cm	300cm	Width Drop cm
60	139.91	154.49	169.06	183.66	198.21	212.79	227.38	241.96	256.55	271.12	285.71	300.30	314.87	60
80	143.64	159.45	175.28	191.11	206.92	222.75	238.58	254.40	270.22	286.03	301.86	317.69	333.53	80
100	147.36	164.42	181.48	198.57	215.64	232.67	249.75	266.83	283.89	300.95	318.03	335.09	352.15	100
120	151.10	169.41	187.71	206.02	224.31	242.63	260.95	279.26	297.57	315.88	334.16	352.50	370.79	120
140	154.83	174.36	193.91	213.49	233.02	252.58	272.14	291.69	311.24	330.78	350.33	369.89	389.45	140
160	158.53	179.33	200.14	220.93	241.73	262.52	283.31	304.10	324.91	345.69	366.48	387.30	408.08	160
180	162.27	184.32	206.35	228.41	250.44	272.44	294.50	316.52	338.57	360.61	382.65			180
200	166.01	189.28	212.57	235.84	259.12	282.41	305.69	328.98	352.25	375.53				200
220	169.73	194.25	218.79	243.30	267.82	292.35	316.86	341.40	365.93					220
240	173.46	199.25	224.99	250.75	276.53	302.28	328.04	353.83						240
260	177.19	204.18	231.20	258.22	285.21	312.22	339.26							260
280	180.93	209.16	237.44	265.66	293.93	322.17								280
300	184.64	214.14	243.64	273.13	302.63	332.12								300

### Price Group 2

### Price Category C

Width Drop cm	60cm	80cm	100cm	120cm	140cm	160cm	180cm	200cm	220cm	240cm	260cm	280cm	300cm	Width Drop cm
60	143.98	159.92	175.88	191.81	207.76	223.69	239.64	255.58	271.51	287.46	303.41	319.34	335.29	60
80	149.08	166.71	184.36	201.99	219.63	237.26	254.90	272.55	290.18	307.82	325.45	343.07	360.72	80
100	154.16	173.49	192.83	212.16	231.50	250.82	270.18	289.49	308.83	328.16	347.50	366.84	386.17	100
120	159.24	180.29	201.32	222.36	243.38	264.40	285.44	306.46	327.50	348.52	369.54	390.58	411.62	120
140	164.35	187.09	209.79	232.52	255.24	277.99	300.69	323.43	346.15	368.89	391.61	414.33	437.04	140
160	169.43	193.85	218.27	242.71	267.11	291.54	315.97	340.40	364.81	389.24	413.64	438.09	462.50	160
180	174.52	200.63	226.76	252.88	279.00	305.12	331.24	357.36	383.46	409.58	435.71			180
200	179.59	207.43	235.23	263.05	290.87	318.66	346.50	374.33	402.14	429.95				200
220	184.70	214.21	243.73	273.22	302.74	332.26	361.76	391.28	420.80					220
240	189.78	220.98	252.22	283.38	314.62	345.84	377.02	408.24						240
260	194.88	227.78	260.68	293.59	326.49	359.39	392.30							260
280	199.97	234.57	269.18	303.77	338.36	372.96								280
300	205.05	241.36	277.64	313.94	350.25	386.55								300

### Price Group 3

### Price Category C

Width Drop cm	60cm	80cm	100cm	120cm	140cm	160cm	180cm	200cm	220cm	240cm	260cm	280cm	300cm	Width Drop ft.ins.
60	165.06	184.88	204.71	224.54	244.35	264.16	283.98	303.80	323.62	343.43	363.25	383.06	402.90	60
80	174.04	196.84	219.65	242.46	265.26	288.07	310.89	333.68	356.50	379.30	402.11	424.91	447.73	80
100	182.99	208.78	234.59	260.38	286.21	311.99	337.77	363.58	389.36	415.15	440.95	466.76	492.54	100
120	191.96	220.74	249.54	278.32	307.09	335.88	364.67	393.47	422.25	451.03	479.82	508.60	537.39	120
140	200.92	232.71	264.47	296.25	328.02	359.79	391.59	423.34	455.12	486.90	518.68	550.44	582.20	140
160	209.91	244.65	279.42	314.19	348.97	383.71	418.48	453.23	488.01	522.75	557.52	592.28	627.06	160
180	218.86	256.62	294.37	332.12	369.88	407.62	445.38	483.13	520.87	558.63	596.39			180
200	227.83	268.57	309.30	350.04	390.80	431.52	472.27	513.03	553.77	594.51				200
220	236.80	280.53	324.26	367.98	411.71	455.44	499.18	542.89	586.64					220
240	245.77	292.48	339.20	385.92	432.63	479.37	526.08	572.79						240
260	254.74	304.45	354.15	403.84	453.58	503.28	552.95							260
280	263.72	316.40	369.08	421.80	474.47	527.19								280
300	272.66	328.36	384.03	439.72	495.40	551.09								300

Child safety device (10482) – add on £8.83.

All prices shown exclude VAT



# Wooden Slat Venetian Blinds

## System 8910

Mono control wooden slat Venetian Blind System.  
Bass wood slat 50mm.

## System 8960

Electrically operated Venetian Blind System.  
Average operating speed 3cm/sec.

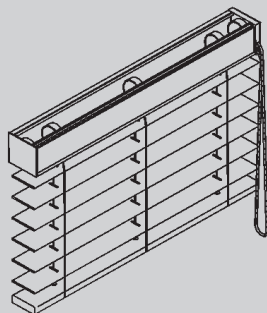

The prices in the table below comprise the complete system made-to-measure with 50mm slats ready to hang with universal bracket 8920. If sizes lie between the measurements shown, the price for the next size larger will apply. Headrail covered with actual slat to match. For F.R. treated wood please add £106.95/m<sup>2</sup> to prices below.

## System 8910 – 50mm Slat size

Max. system width: 243cm      Min. system width: 65cm  
Max. system drop: 275cm      Max. surface area: 4.6m<sup>2</sup>

Price Category C

Width ► Drop ▼ cm	80cm	100cm	120cm	140cm	160cm	180cm	200cm	220cm	245cm	◀ Width ▼ Drop cm
80	259.04	319.47	339.15	420.18	505.80	505.80	553.02	574.65	623.87	80
90	265.19	326.52	347.08	431.03	449.40	518.57	568.70	591.39	641.67	90
100	271.33	333.56	354.97	441.86	461.19	531.36	584.36	608.12	659.45	100
110	280.55	344.14	366.87	458.04	478.88	550.53	607.89	633.17	686.05	110
120	296.87	387.73	387.73	468.85	490.71	563.30	623.57	649.90	703.84	120
130	313.18	382.27	408.61	479.66	502.51	576.08	639.25	666.63	721.61	130
140	326.96	398.04	426.31	501.35	526.13	601.65	670.56	700.06	757.12	140
150	332.13	403.94	432.98	509.45	535.00	611.25	682.35	712.60	770.46	150
160	337.28	409.83	439.62	517.55	543.84	620.88	694.10	725.14	783.79	160
170	351.06	425.60	457.28	539.18	567.40	646.43	709.76	758.55	819.32	170
180	365.57	442.44	475.89	561.32	591.30	672.70	725.47	775.29	837.06	180
190	380.08	459.27	494.52	583.44	615.18	698.96	756.79	792.03	854.82	190
200	391.02	471.84	508.65	600.72	633.98	719.33	780.31	817.12		200
210	398.36	480.20	518.05	612.22	646.52	732.91	796.01			210
220	405.70	488.55	527.45	623.72	659.07	746.47	811.68			220
230	420.29	505.25	546.25	646.66	684.16	773.66	843.00			230
240	425.80	511.54	553.30	655.31	693.56	782.80				240
250	431.30	517.83	560.34	663.94	702.96	794.04				250
260	445.90	534.54	579.16	686.94	728.05	821.22				260
275	462.51	548.96	593.54	701.34	740.85					275

## 50mm Slat (standard/premium colours)

Slat Description

Standard Colours – Use above price chart

Alabaster	Light Oak	Sandwash
Alpine	Linen	Soft White
Cloud	Natural	Stark
Eggshell	New Walnut	Sugar Maple
Golden Oak	New Wenge	Yarrin
Holstein	Pecan	

Slat Description

Premium Colours – Use above price chart plus 20%

Acid	Envy	Hypnosis	Matumi	Zura
Astro	Exquis	Icon	Nata	
Caroba	Feline	Isiro	Orali	
Cassia	Fizz	Koli	Pardo	
Cirrus	Gravity	Koto	Poison	
Electric	Halti	Lulu	Vamp	

**Note:** Premium Colours are supplied with white headbox and accessories as standard. Silver, bronze and vanilla are also available on request.

Wooden slat Venetian blinds are made with natural wood. It is therefore an inherent feature of the product that variation in shade and graining as well as slight warping may occur.

For Premium colour/finishes as detailed above: an additional cost of 20% applies.

TAPED VENETIAN System 8910 is available with fabric tapes at an additional cost of 7.5%.

Please enquire at Silent Gliss for information about the colours available.

## System 8960 – Electrically Operated Venetian Blind System (50mm wooden slat)

Max. system width: 243cm      Min. system width: 75cm  
Max. system drop: 275cm      Max. surface area: 4.6m<sup>2</sup>

Electrically operated with integral 230v motor no. 0611. Supplied with special recess switch 0613 as standard. For pricing, add to relevant price in table above the sum of £726.71

System 8960 is available with fabric tapes at an additional cost of 7.5%.

SIDE-GUIDES are available for both systems at an additional cost of £24.93

All prices shown  
exclude VAT



# Aluminium Slat Venetian Blind

## System 8910

Mono control Venetian Blind System.  
Aluminium slat 50mm.

## System 8960

Electrically operated Venetian Blind System.  
Average operating speed 3cm/sec.

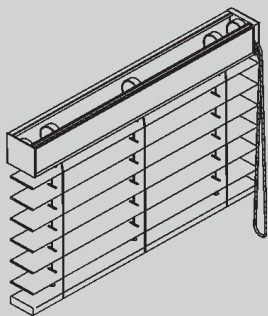

The prices in the table below comprise the complete system made-to-measure with 50mm slats ready to hang with universal bracket 8920. If sizes lie between the measurements shown, the price for the next size larger will apply. Headrail covered with actual slat to match. Plus coordinating or contrasting component options. Please refer to 8910 catalogue for recommended (standard) colour combinations. Multicoloured blinds please add 20% to prices below.

## System 8910 – 50mm Slat size

Max. system width: 360cm  
Max. system drop: 360cm  
Min. system width: 65cm  
Max. surface area: 10m<sup>2</sup>

Width ▶ Drop ▼ cm	Price Category C																Width ▼ Drop cm
	60cm	80cm	100cm	120cm	140cm	160cm	180cm	200cm	220cm	240cm	260cm	280cm	300cm	320cm	340cm	360cm	
60	106.65	134.73	162.84	190.87	218.98	247.01	275.16	303.28	331.33	359.39	387.42	415.56	443.64	471.70	499.81	527.87	60
70	109.63	137.74	165.75	193.86	221.97	250.04	278.10	306.17	334.26	362.41	390.47	418.54	446.61	474.64	502.78	530.83	70
80	112.64	140.74	168.75	196.86	224.90	253.03	281.12	309.16	337.22	365.32	393.40	421.53	449.60	477.62	505.69	533.85	80
90	115.58	143.66	171.76	199.84	227.92	255.98	284.10	312.13	340.22	368.30	396.41	424.48	452.53	480.64	508.68	536.79	90
100	118.56	146.63	174.72	202.83	230.88	258.96	287.08	315.14	343.18	371.32	399.35	427.46	455.52	483.60	511.69	539.76	100
110	121.51	149.59	177.71	205.76	233.87	261.92	290.01	318.13	346.16	374.30	402.34	430.40	458.44	486.57	514.69	542.77	110
120	124.48	152.62	180.65	208.73	236.87	264.90	293.01	321.08	349.15	377.06	405.32	433.41	461.46	489.52	517.63	545.70	120
130	127.48	155.60	183.65	211.70	239.77	267.86	295.96	324.07	352.14	380.21	408.29	436.35	464.49	492.57	520.62	548.66	130
140	130.46	158.55	186.66	214.68	242.79	270.85	298.92	326.99	355.12	383.17	411.24	439.40	467.43	495.51	523.62	551.67	140
150	133.42	161.52	189.61	217.67	245.76	273.85	301.93	330.02	358.07	386.13	414.16	442.34	470.39	785.11	526.58	554.61	150
160	136.41	164.48	192.58	220.65	248.73	276.80	304.91	332.98	361.03	389.14	417.18	445.31	473.37	501.44	529.56	557.58	160
170	139.38	167.50	195.49	223.61	251.74	279.79	307.90	335.95	363.97	392.09	420.19	448.30	476.35	504.38	532.49	560.57	170
180	142.36	170.49	198.48	226.55	254.64	282.77	310.86	338.93	366.99	395.08	423.14	451.24	479.31	507.38	535.46	563.57	180
190	145.36	173.40	201.51	229.60	257.66	285.69	313.82	341.89	369.96	398.08	426.14	454.25	482.30	510.35	538.43	566.49	190
200	148.30	176.38	204.48	232.52	260.64	288.67	316.75	344.85	372.92	401.07	429.10	457.19	485.26	513.36	541.49	569.53	200
210	151.27	179.33	207.46	235.52	263.62	291.71	319.71	347.78	375.90	403.98	432.11	460.18	488.20	516.29	544.41	572.51	210
220	154.22	182.35	210.38	238.50	266.57	294.63	322.77	350.85	378.91	406.95	435.04	463.13	491.23	519.28	547.40	575.42	220
230	157.21	185.30	213.38	241.47	269.54	297.60	325.71	353.81	381.90	409.95	438.03	466.08	494.16	522.26	550.36	578.43	230
240	160.22	188.31	216.38	244.44	272.50	300.58	328.67	356.80	384.85	412.93	440.98	469.08	497.16	525.21	553.35	581.37	240
250	163.16	191.27	219.43	247.39	275.46	303.57	331.64	359.75	387.82	415.92	443.95	472.06	500.10	528.22	556.32	584.36	250
260	166.17	194.23	222.30	250.39	278.47	306.55	334.66	362.70	390.76	418.88	446.94	475.07	503.15	531.18	559.25	587.34	260
270	169.12	197.22	225.27	253.34	281.42	309.53	337.64	365.68	393.73	421.83	449.90	478.04	506.09	534.18	562.26	590.33	270
280	172.08	200.20	228.24	256.32	284.41	312.46	340.63	368.68	396.73	424.80	452.88	480.99	509.06	537.13	565.19	593.32	280
290	175.07	203.14	231.23	259.30	287.43	315.45	343.57	371.64	399.69	427.81	455.87	483.91	512.03	540.08	568.22	596.27	290
300	178.00	206.14	234.20	262.24	290.39	318.45	346.52	374.62	402.66	430.78	458.90	486.95	515.00	543.06	571.16		300
310	181.00	209.12	237.16	265.24	293.35	321.41	349.49	377.56	405.66	433.72	461.86	489.94	517.97	546.05	574.13		310
320	183.96	212.09	240.15	268.24	296.35	324.37	352.45	380.56	408.63	436.71	464.77	492.89	520.98	549.06			320
330	186.96	215.01	243.13	271.23	299.27	327.36	355.44	383.46	411.61	439.71	467.75	495.86	523.91	552.03			330
340	189.93	218.02	246.08	274.18	302.24	330.35	358.44	386.52	414.57	442.66	470.73	498.81	526.89				340
350	192.92	220.98	249.08	277.16	305.24	333.30	361.40	389.50	417.55	445.66	473.71	501.83	529.85				350
360	195.89	224.03	252.06	280.11	308.20	336.29	364.39	392.44	420.53	448.59	476.70	504.77	532.85				360

## System 8960 – Electrically Operated Venetian Blind System (50mm aluminium slat)

Max. system width: 360cm  
Max. system drop: 360cm  
Min. system width: 75cm  
Max. surface area: 10m<sup>2</sup>

Electrically operated integral 230v motor no. 0611. Supplied with special recess switch 0613 as standard. For pricing, add to relevant price in table above the sum of £726.71

System 8960 is available with fabric tapes at additional cost of 7.5%.

SIDE-GUIDES are available for both systems at an additional cost of £24.93

All prices shown exclude VAT



# Leather Slat Venetian Blinds

## System 8910

Mono control leather slat Venetian Blind System with low descent mechanism (50mm).

## System 8960

Electrically operated Venetian Blind System. Average operating speed 3cm/sec.

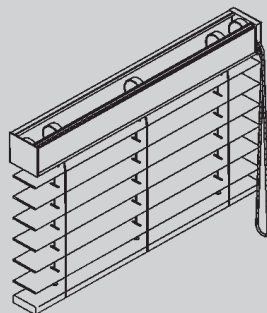

The prices in the table below comprise the complete system made-to-measure with 50mm slats ready to hang with universal bracket 8920. If sizes lie between the measurements shown, the price for the next size larger will apply. Headrail covered with actual slat to match. Plus coordinating or contrasting component options. Please refer to 8910 catalogue for recommended (standard) colour combinations. Leather venetian slats are a natural product, therefore slight variations in colour and texture are an inherent feature. Headrails are sprayed to match system colour as standard.

## System 8910 – 50mm Slat size

Max. system width: 243cm  
 Max. system drop: 275cm  
 Min. system width: 65cm  
 Max. surface area: 4.6m<sup>2</sup>

Price Category C

Width ► Drop ▼ cm	80cm	100cm	120cm	140cm	160cm	180cm	200cm	220cm	245cm	◀ Width ▼ Drop cm
80	592.45	706.36	835.00	948.86	1075.58	1188.94	1302.80	1419.60	1532.96	80
90	646.30	773.64	916.27	1043.57	1183.18	1310.48	1437.83	1567.52	1694.87	90
100	700.69	840.92	997.00	1137.74	1291.29	1432.07	1572.31	1715.99	1856.74	100
110	754.53	908.71	1078.22	1232.45	1399.44	1553.12	1707.30	1864.42	2018.65	110
120	808.37	976.00	1158.95	1326.61	1507.04	1674.67	1842.33	2014.36	2181.98	120
130	862.76	1043.83	1240.22	1421.28	1615.19	1796.26	1978.79	2162.83	2343.89	130
140	916.61	1111.11	1320.94	1515.44	1722.80	1919.27	2113.82	2311.26	2505.80	140
150	970.45	1178.39	1402.21	1610.15	1830.91	2040.32	2248.30	2459.73	2667.67	150
160	1024.80	1246.22	1482.89	1704.32	1940.53	2161.91	2383.29	2608.16	2829.58	160
170	1078.64	1313.51	1564.16	1799.03	2048.13	2283.50	2518.32	2756.08	2991.45	170
180	1132.49	1381.30	1644.89	1895.17	2156.24	2404.54	2653.35	2927.11	3175.91	180
190	1186.88	1448.58	1726.16	1989.33	2264.39	2526.09	2788.34	3075.53		190
200	1240.72	1515.86	1808.35	2084.04	2371.99	2647.68	2945.38	3224.00		200
210	1294.57	1583.69	1889.58	2178.20	2480.10	2769.27	3080.41	3372.47		210
220	1348.91	1650.98	1970.30	2272.87	2588.25	2912.83	3215.39			220
230	1402.76	1720.24	2051.57	2367.04	2695.85	3034.42	3350.42			230
240	1456.60	1787.52	2132.30	2461.75	2826.56	3156.01				240
250	1510.45	1854.80	2213.02	2555.91	2934.16	3277.05				250
260	1564.84	1922.63	2294.25	2650.58	3042.27					260
275	1620.15	1989.92	2374.97	2767.84	3150.42					275

## System 8960 – Electrically Operated Venetian Blind System (50mm leather slat)

Max. system width: 243cm  
 Max. system drop: 275cm  
 Min. system width: 75cm  
 Max. surface area: 4.6m<sup>2</sup>

Electrically operated with integral 230v motor no. 0611. Supplied with special recess switch 0613 as standard. For pricing, add to relevant price in table above the sum of £726.71

**SIDE-GUIDES** are available for both systems at an additional cost of £24.93

Leather covered headrail available for both systems at an additional cost of £472.50 per blind

All prices shown exclude VAT



# Plissée Pleated Blinds

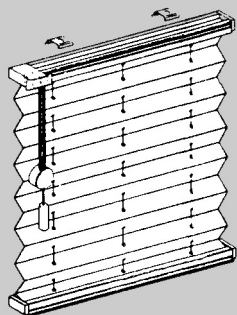

## System 8500

Plissée Pleated Blind System supplied complete ready made.  
White aluminium head and bottom rail. Pleats 20mm.

Plissée Pleated Blind Systems are supplied made-to-measure, ready to install. White aluminium headrail and components are standard and brown is also available.

Please use our technical information leaflet to determine the required Plissée model and contact Silent Gliss for a price.

Choose from following model types:

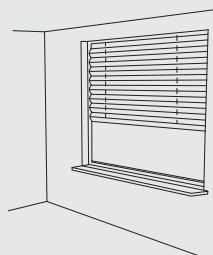

### Model Type 'A' – Vertical Freehanging

Electric Operation: AE10

Chain Operation: AK10

Pull Cord Operation: A010, A013, A020, A030, A040, A070

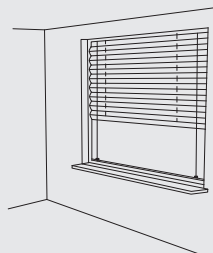

### Model Type 'B' – Vertical Side-Guide

Electrical Operation: BE10

Handle Operation: BB10, BB10U, BB20, BB20U, BB24, BB30, BB80, BB81, BB85

Chain Operation: BK10

Pull Chord Operation: B010, B020, B060, B061, B075

Fixed: BF50, BF51, BF52, BF55, BF56

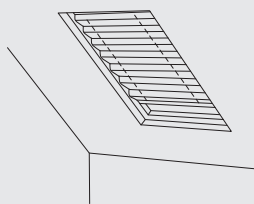

### Model Type 'D' – Inclined

Handle Operation: DB10, DB10U, DB20, DB30

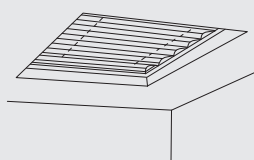

### Model Type 'P' – Horizontal

Handle Operation: PB10, PB15, PB30, PB35, PB40, PB41, PB45, PB46, PB60, PB61, PB65, PB66, PB70, PB71, PB75, PB76, PB80, PB81, PB85, PB86

Electrical Operation: PE10, PE15, PE60, PE61, PE65, PE66, PE70, PE71, PE75, PE76

Crank Operation: PR10, PR15, PR60, PR61, PR65, PR66, PR70, PR71, PR75, PR76

PRICING: Price on application – please contact Silent Gliss

All prices shown exclude VAT



## Logo and Digital Printing

We are able to print logos and images on a wide variety of fabrics, including Screens, Visiotex, Element, Mercurio B and Colorama. It is important to note that the denser the fabric, the better the quality of the image transfer.

Suitable artwork must be provided with a reasonable size and high d.p.i. (dots per inch). Prices on application.

For more information please see Digital Printing brochure.

## Special Colours – Profile and Components

Standard stock colours are indicated and priced accordingly on the relevant system page.

In addition, any UK powder manufacturer's standard/stock RAL or BS colour may also be matched by spraying (delivery 4 weeks).

For Dim-Out blinds, please refer to pricing on page 53. For all other systems, the following charges apply:

	Price Ctg.
<b>Set-up charge (1 per colour)</b>	<b>E</b>
Standard/stock RAL or BS colours: £220.48	
Standard Silent Gliss colours (excluding gold/chrome): £105.00	
Non-standard RAL or BS colours: POA	
<b>Plus add the following prices to the relevant assembled system price (use silver finish):</b>	
£6.21 per metre of profile	
£8.28 per set of endcovers/wall supports/endpieces/cord guides	
For tracks with sprayable brackets please use bracket spraying cost below.	
Note:	
Profile should not be bent once sprayed.	
Maximum sprayed profile length is 6 metres.	
Nylon components sprayed to colour match may sustain damage in the future.	
<b>Metropole Coloured Extension Brackets</b>	<b>E</b>
Set up charge: £105.00 (Chrome and Gold only)	
Spray charge: £6.81 per bracket and bracket cover	
Drilling charge: £3.41 per bracket	
Lead time approx. 6 weeks.	





# Made-to-measure Curtains

# Wave®

## CURTAIN HEADING SYSTEM

Curtain prices need to be added to the hardware prices.

Prices are for unlined curtains.

For standard lining add 10% or for blackout lining add 15%.

### Price Category A

#### Price Group 1 Fabrics

Colorama 1  
Someo  
Sunset

Width ► Drop ▼	150cm	200cm	250cm	300cm	350cm	400cm	450cm	500cm	◀ Width ▼ Drop
Up to 300cm	334.26	445.68	557.10	668.51	779.94	891.35	1002.77	1114.19	Up to 300cm
301-350cm	500.83	668.51	836.19	1003.87	1171.55	1339.23	1506.91	1674.59	301-350cm
351-400cm	575.85	768.91	961.95	1155.01	1348.06	1541.11	1734.16	1927.22	351-400cm

#### Price Group 2 Fabrics

Breeze  
Freshtex Light  
Freshtex Ultralight  
Colorama 2  
Natural  
Colorama 1 Alu  
Colorama 2 Bioactive

Freshtex Linlook  
Twist  
Freshtex Vision  
Reflex  
Silente 20

Width ► Drop ▼	150cm	200cm	250cm	300cm	350cm	400cm	450cm	500cm	◀ Width ▼ Drop
Up to 300cm	458.91	611.15	763.38	915.62	1067.86	1220.09	1372.33	1524.56	Up to 300cm
301-350cm	688.37	916.73	1145.08	1373.43	1601.78	1830.14	2058.49	2286.85	301-350cm
351-400cm	792.07	1054.62	1317.17	1579.72	1842.27	2104.82	2367.37	2629.92	351-400cm

#### Price Group 3 Fabrics

Deep  
Freshtex Dimout  
Linea  
Newlife 1/2  
Silente 10

Width ► Drop ▼	150cm	200cm	250cm	300cm	350cm	400cm	450cm	500cm	◀ Width ▼ Drop
Up to 300cm	895.76	1193.62	1491.47	1789.32	2087.17	2385.02	2682.88	2980.73	Up to 300cm
301-350cm	1343.64	1790.43	2237.20	2683.98	3130.76	3577.54	4024.31	4471.10	301-350cm
351-400cm	1544.42	2058.49	2572.56	3086.63	3600.70	4114.77	4628.84	5142.91	351-400cm

#### Fabric Joining Information

By reducing the number of joins the overall curtain appearance improves. The table below indicates the maximum drop available **without joins** for each fabric.

Max drop 210cm	Max drop 265cm	Max drop 285cm	Max drop 290cm		Max drop 300cm	
Colorama 1 Alu	Somnia*	Leviso*	Freshtex Ultralight Freshtex Vision Freshtex Light Newlife 1/2 Silente 10	Deep Freshtex Dimout Linea Sevena Silente 20	Breeze Colorama 2 Colorama 1	Twist Colorama 2 Bioactive

\*For Wave XL only.

All prices shown exclude VAT



# Made-to-measure Curtains

## Wave XL

### CURTAIN HEADING SYSTEM

Curtain prices need to be added to the hardware prices.

Prices are for unlined curtains.

For lined curtains add 5%.

For blackout lined curtains add 10%.

Fabrics included in Price Group 1 are: Breeze Colorama 1 Someo Sunset

Price Category C

Width ► Drop ▼ cm	150cm	200cm	250cm	300cm	350cm	400cm	450cm	500cm	◀ Width ▼ Drop cm
100	314.75	419.71	524.59	629.52	734.47	839.36	944.30	1,049.22	100
150	409.30	545.72	682.16	818.60	955.02	1,091.44	1,227.87	1,364.32	150
200	503.82	671.76	839.69	1,007.66	1,175.57	1,343.50	1,511.47	1,679.39	200
250	598.35	797.79	997.25	1,196.72	1,396.15	1,595.59	1,795.04	1,994.48	250
300	692.90	923.83	1,154.78	1,385.74	1,616.71	1,847.66	2,078.62	2,309.60	300
350	787.41	1,049.87	1,312.33	1,574.80	1,837.28	2,099.75	2,362.19	2,624.68	350
400	881.94	1,175.88	1,469.88	1,763.86	2,057.85	2,351.82	2,645.77	2,939.78	400

Fabrics included in Price Group 2 are: Colorama 1 Alu  
Freshtex Light  
Leviso  
Somnia  
Colorama 2  
Freshtex Linlook  
Natural  
Twist  
Colorama 2 Bioactive  
Freshtex Ultralight  
Silente 20

Price Category C

Width ► Drop ▼ cm	150cm	200cm	250cm	300cm	350cm	400cm	450cm	500cm	◀ Width ▼ Drop cm
100	465.75	621.01	776.22	931.49	1,086.74	1,241.97	1,397.23	1,552.49	100
150	610.61	814.13	1,017.67	1,221.20	1,424.73	1,628.28	1,831.80	2,035.35	150
200	755.46	1,007.28	1,259.10	1,510.91	1,762.73	2,014.53	2,266.37	2,518.17	200
250	900.32	1,200.42	1,500.52	1,800.61	2,100.73	2,400.82	2,700.93	3,001.03	250
300	1,045.17	1,393.55	1,741.93	2,090.35	2,438.73	2,787.10	3,135.48	3,483.89	300
350	1,190.01	1,586.69	1,983.35	2,380.04	2,776.73	3,173.39	3,570.05	3,966.74	350
400	1,334.87	1,779.83	2,224.80	2,669.75	3,114.72	3,559.67	4,004.62	4,449.59	400

Fabrics included in Price Group 3 are: Deep  
Linea  
Newlife 2  
Silente 10  
Freshtex Dimout  
Linea Alu  
Reflex  
Freshtex Vision  
Newlife 1

Price Category C

Width ► Drop ▼ cm	150cm	200cm	250cm	300cm	350cm	400cm	450cm	500cm	◀ Width ▼ Drop cm
100	587.87	783.87	979.79	1,175.75	1,371.74	1,567.66	1,763.62	1,959.62	100
150	773.46	1,031.28	1,289.06	1,546.90	1,804.69	2,062.52	2,320.34	2,578.16	150
200	959.03	1,278.69	1,598.37	1,918.03	2,237.71	2,557.38	2,877.05	3,196.69	200
250	1,144.59	1,526.10	1,907.62	2,289.16	2,670.66	3,052.22	3,433.75	3,815.27	250
300	1,330.13	1,773.53	2,216.90	2,660.30	3,103.68	3,547.06	3,990.43	4,433.81	300
350	1,515.72	2,020.94	2,526.18	3,031.44	3,536.66	4,041.90	4,547.12	5,052.37	350
400	1,701.28	2,268.37	2,835.44	3,402.53	3,969.65	4,536.74	5,103.83	5,670.94	400

All prices shown exclude VAT



## Made-to-measure Curtains

# Snake Wave®

Supplied ready assembled complete with curtain.  
 Prices are for unlined curtains.  
 1060 available in anodised or white powder coated finish.  
 6465 available in white powder coated as standard.  
 Top fix only.  
 Standard hem is with overlapped stitching.  
 Single stack only.

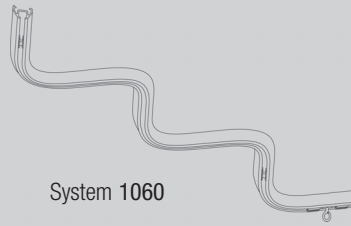

System 1060

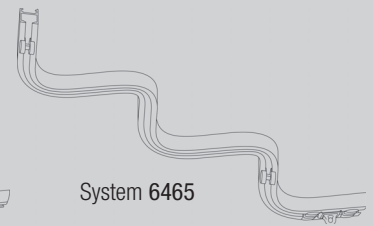

System 6465

### Silent Gliss 1060

Hardware including fabric up to 3 meter drop.

Price Category C

Width ►	71cm	111cm	151cm	191cm	231cm	271cm	311cm	351cm	391cm	431cm	471cm
Price Group 1	435.07	499.30	565.35	631.40	890.05	956.10	1022.15	1063.08	1108.19	1149.12	1374.27
Price group 2	548.11	612.35	678.40	744.45	1116.14	1182.19	1248.24	1293.36	1334.29	1375.22	1713.42
Price group 3	707.22	775.64	841.69	903.55	1438.54	1504.59	1566.45	1611.57	1656.68	1697.61	2194.92
Price group 4	841.20	905.43	971.48	1037.53	1702.32	1768.37	1834.42	1879.53	1920.46	1961.39	2592.68
Optional Deep Hem	16.75	25.12	33.50	41.87	50.24	58.62	66.99	96.30	125.61	159.10	200.97

### Silent Gliss 6465

Hardware including fabric up to 3 meter drop.

Price Category C

Width ►	86cm	134cm	182cm	230cm	278cm	326cm	374cm	422cm	470cm
Price group 1	442.53	510.05	581.72	845.98	913.46	980.94	1052.65	1099.19	1334.15
Price group 2	559.77	623.10	694.77	1072.08	1139.56	1211.22	1278.74	1325.29	1673.29
Price group 3	718.87	786.39	853.87	1394.48	1461.95	1529.43	1601.14	1647.68	2154.79
Price group 4	852.86	916.19	987.85	1658.25	1725.73	1797.40	1864.92	1911.46	2552.50
Optional Deep Hem	20.93	33.50	41.87	50.24	62.80	71.18	79.55	113.05	150.73

Price Group 1	Price Group 2	Price Group 3	Price Group 4
Breeze Colorama 1 Someo	Colorama 1 Alu Colorama 2 Colorama 2 Bioactive Freshtex Light Freshtex Linlook Freshtex UltraLight Freshtex Vision Natural Sunset Twist	Leviso Newlife 1 Reflex Silente 20 Somnia	Deep Freshtex Dimout Linea Newlife 2 Silente 10

All prices shown exclude VAT

# Price Index for Rails & Parts

All prices shown  
exclude V.A.T.

Product	Description	Unit Prices					Per Metre Price				Ctgy
		Each	Per 10	Per 100	Other Qty	Price	1m	100m	Other Lgth	Price	
18R	Round Head Screw No.8, 25mm/1"			14.32							A
28C	Counter Sunk Screw No.8, 50mm/2"			17.78							A
28R	Round Head Screw No.8, 50mm/2"			27.02							A
148C	Counter Sunk Screw No.8, 19mm/3/4"			14.94							A
0222	Screw for 5600 Direct Fix	0.05		4.20							C
0240	Screw for 6243 Profile	0.32		30.38							A
0273	Connecting Bridge for 6140, Antique Bronze, Black, Silver, Steel Grey, Taupe, White	25.20									A
0273	Connecting Bridge for 6140, Oak	29.93									A
0286	Cable Clips	0.11									C
0270	RACUB Module	370.91									C
0304	36mm Wood/Matched Fused Barrel finial pair (all colours except chrome matched)	90.38	831.54								A
0308	23mm Wood/Matched Fused Barrel finial pair (all colours except chrome matched)	82.72	719.67								A
0311	30mm Wood/Matched Fused Barrel finial pair (all colours except chrome, classic gold and oak matched)	97.94	852.08								A
0315	50mm Wood/Matched Fused Barrel finial pair (all colours except oak matched)	159.73	1389.53								A
0318	36mm Wood/Matched Fused Ball finial pair (all colours except chrome matched)	96.68	889.46								A
0321	23mm Wood/Matched Fused Ball finial pair (all colours except chrome matched)	88.45 pair	769.48								A
0324	30mm Wood/Matched Fused Ball finial pair (all colours except chrome, classic gold and oak matched)	104.41 pair	908.44								A
0327	50mm Wood/Matched Fused Ball finial pair (all colours except oak matched)	158.66	1380.35								A
0329	23mm Glass Ball finial clear or frosted (all pole colours)	46.71	406.37								A
0331	30mm Glass Ball finial clear or frosted (all colours except oak - see below)	49.57	431.28								A
0331	30mm Glass Ball finial clear or frosted (for oak poles)	78.91	686.52								A
0333	50mm Glass Ball finial clear or frosted (all colours except oak-see below)	93.95	817.33								A
0333	50mm Glass Ball finial clear or frosted (for oak poles)	97.94	852.07								A
0334	Maxi Adjustable Bracket, silver, black, white, cream, gunmetal, steel grey, bronze, antique bronze, sand, taupe	31.72	271.86								A
0334	Maxi Adjustable Bracket, oak	57.68	501.48								
0335	Top Fix Bracket, silver, black, white, cream, gunmetal, steel grey, bronze, antique bronze, sand, taupe, gold.	16.05	137.54								A
0335	Top Fix Bracket, oak, chrome	29.85	259.56								
0340	30mm Cording Set without endcap, silver, black, white, cream, classic gold, gunmetal, steel grey, bronze, antique bronze, sand, taupe, chrome	43.26	402.50								A
0340	30mm Cording Set without endcap, oak	57.00	530.30								A
0347	50mm Cording Set without endcap, silver, black, white, steel grey, taupe, antique bronze	51.52	489.48								A
0347	50mm Cording Set without endcap, oak	80.77	767.37								A
0339	23mm Flush Endcap, silver, black, white, gunmetal, taupe, chrome	8.72	85.16								A
0346	30mm Flush Endcap, silver, black, white, cream, classic gold, gunmetal, steel grey, bronze, antique bronze, sand, taupe, chrome	7.44	70.54								A
0346	30mm Flush Endcap, oak	12.50	122.00								A
0350	50mm Flush Endcap, white, black, silver	23.16	227.00								A
0350	50mm Flush Endcap, steel grey, oak, taupe	23.73	232.55								A
0351	36mm Flush Endcap, silver, black, white, gunmetal, chrome, bronze, antique bronze, steel grey	7.54	73.98								A
0516	Clearance spacer (for top boards)			60.00							A
0521	Motor lead	90.56									C
0537	Adjustable Metropole bracket, silver, black, gunmetal, white, cream, steel grey, bronze, antique bronze, sand, taupe	7.12									A
0537	Adjustable Metropole bracket, chrome, classic gold, oak	8.13									A
0551	Diagonal fixing support complete including track and wall fixings	75.95			metre drop	11.99					A
0552	Transfer unit for loading device	227.45									A
0553	Connecting bridge for loading device	49.91									A
0554	Loading device access	106.29									A
0556	Ball end, silver, white, cream, black, classic gold, gunmetal, chrome, steel grey, bronze, antique bronze, sand, taupe 30mm poles	25.25	239.90								A
0556	Ball end, oak 30mm poles	28.92	269.88								A
0562	Lead with in-line connector	94.62									C
0565	Non latching recess switch, white, 1 gang	94.48									C
0566	Non latching recess switch, white, 2 gang	163.56									C
0567	Non latching recess switch, white, 3 gang	254.69									C
0568	Non latching recess switch, white, 4 gang	323.78									C

# Price Index for Rails & Parts

All prices shown  
exclude V.A.T.

Product	Description	Unit Prices				Per Metre Price				Qty
		Each	Per 10	Per 100	Other Qty	Price	1m	100m	Other Lgth	
0569	Non latching recess switch, white, 6 gang	488.81								C
0570	Volt free switching module	178.43								C
0593	Gland set for 5682	3.28								C
0595	Swivel plate	125.11								C
0614ST	Wireless switch, white	107.17								C
0616	Latching recess switch, white, 2 gang	68.77								C
0617	Latching recess switch, white, 3 gang	111.76								C
0618	Latching recess switch, white, 4 gang	134.40								C
0619	Latching recess switch, white, 6 gang	186.26								C
0628	Groove cylinder finial for 1003	17.69								A
0629	Groove cylinder finial for 6130	21.49								A
0630	Groove cylinder finial for 6140	49.71								A
0646	50mm intermediate pulley set (for 6160), white, silver, black	60.47								A
0646	50mm intermediate pulley set (for 6160), oak, steel grey, taupe, antique bronze	66.96								A
0652	Screw	0.08								A
0661	Side guide wire						0.82			A
0674	Pillar bracket, white, silver, black, cream	9.88								A
0674	Pillar bracket, chrome, classic gold, , gunmetal, steel grey, bronze, antique bonze, sand, taupe	10.37								A
0674	Pillar bracket, oak, chrome	25.49								A
0686	Bottom weight 89mm/3 1/3" without horns			95.90						C
0687	Bottom weight 127mm/5" without horns			74.82						C
0690	Cord Connector White	2.20	20.90							A
0697	50mm Stata hand clear/ribbed disc, silver, black, white, steel grey, taupe, antique bronze	66.06	614.37							A
0697	50mm Stata hand clear/ribbed disc, , oak	95.54	888.52							A
0697	50mm Stata hand coloured disc, silver, black, white, , steel grey, taupe, antique bronze	76.40	710.55							A
0697	50mm Stata hand coloured disc, , oak	105.88	984.71							A
0700	Profile for 6140 silver, white, black						41.46			A
0700	Profile for 6140 , steel grey, oak, taupe, antique bronze						56.19			A
0701	50mm corded profile, white, silver, black						65.53			A
0701	50mm corded profile, oak, , steel grey, taupe, antique bronze						75.96			A
0706	Stud endcap for 1003, silver, white, black, chrome, gunmetal, taupe	8.72	85.17	792.21						A
0707	Stud endcap for 6130, silver, white, cream, black, gunmetal, classic gold, chrome effect, steel grey, antique bronze, sand, taupe	7.43	70.54	670.15						A
0707	Stud endcap for 6130, oak	12.50	122.00	1161.92						A
0710	Stud endcap for 6101, silver, white, black, gunmetal, chrome, steel grey, bronze, antique bronze (includes grub screw)	7.54	71.70	679.26						A
0714	Stud endcap for 6140 50mm, silver, white, black,	23.16								A
0714	Stud endcap for 6140 50mm, diva gold, steel grey, oak, taupe	23.73								A
0715	Dustcap for 6650 (2.5m length)							1m	5.39	A
0717	Ballend finial 50mm silver, white, black, antique bronze, steel grey, taupe, oak,	74.04								A
0718	Spear finial 50mm silver, white, black, antique bronze, steel grey, taupe, oak,	74.04								A
0719	Spear finial 30mm silver, white, black, antique bronze, steel grey, taupe, oak,	36.53								A
0724	Connecting Bridge with Cover for 6130 All Colours	14.27								A
0766	In line connector for electric Roller blinds	59.48								C
0785	Acrylic disc for use with 6655	6.97								A
0798	M4 x 10 countersunk screw (for 6138P/6141)			22.49						A
0839	Knot Holder	0.43								A
0871	Profile for 6150, white, silver						34.55			A
0871	Profile for 6150, black						42.14			A
0871	Profile for 6150, steel grey, antique bronze, taupe						46.82			A
0873	Design end cap for 6130, black, silver, white, steel grey, bronze, taupe, sand, antique bronze	16.43								A
0873	Design end cap for 6130, oak	22.61								A
0877	Hook & Latch Set	1.37		133.10						A
0878	Breakway Ring Set Sofffold	0.88		85.94						A
0879	Breakway Ring Set Sofffold (per metre)						8.21			A
0884	Crystal 23mm	45.93								A
0886	Crystal 30mm	60.52								A
0894	Crystal cylinder 23mm, base in white, silver, black, cream	52.46	487.84							A
0894	Crystal cylinder 23mm, base in chrome, gunmetal, taupe	56.23	522.98							A
0896	Crystal cylinder 30mm, base in white, silver, black, cream	63.86	593.98							A

# Price Index for Rails & Parts

All prices shown  
exclude V.A.T.

Product	Description	Unit Prices					Per Metre Price				Ctgy
		Each	Per 10	Per 100	Other Qty	Price	1m	100m	Other Lgth	Price	
0896	Crystal cylinder 30mm, base in chrome, bronze, classic gold, gunmetal, steel grey, antique bronze, sand, taupe	68.41	636.16								A
0898	Crystal square 50mm base	78.36									A
0899	Crystal cylinder 50mm base	81.95									A
0900	Timer for 5300/5400/5420 incl remote control	309.02									C
0901	30mm Strata Hand clear/ribbed disc - standard colours	34.16									A
0901	30mm Strata Hand coloured disc - standard colours	46.16									A
0901	30mm Strata Hand clear/ribbed disc - oak/chrome	49.79									A
0901	30mm Strata Hand coloured disc - oak/chrome	61.84									A
0907	Control module (low voltage motor Type A)	293.95									C
0913	Single-channel wall switch, brushed silver, mirror finish	213.24									C
0913	Single-channel wall switch, brass	244.49									C
0914	Eight-channel wall switch, brushed silver, mirror finish	213.24									C
0914	Eight-channel wall switch, brass	244.49									C
0915	Single-channel remote control	202.86									C
0917	White pattress box	19.04									C
0918	Control Module (Motor Type A)	272.28									C
0919	Control Module (Motor Type B)	272.28									C
0921	Booster for 0450 system	378.86									C
0922	Power supply for 0921 booster	109.54									C
0937	Programmable switch for 8250	129.37									C
0938	Black box for 0937	6.91									C
0939	Multi channel transmitter	263.78									C
0985	Groove Ball finial for 1003	39.25									A
0989	Blok Bracket, black, silver, gunmetal, steel grey, bronze, antique bronze, white, cream, classic gold, sand, taupe (for poles)	30.12									A
0989	Blok bracket in chrome, oak	45.19									A
0991 CL	Shard Flat clear finial for 6100	33.43									A
0991 ET	Shard Flat etched finial for 6100	41.15									A
0993 CL	Shard Cylinder clear finial for 1003	36.38									A
0993 ET	Shard Cylinder etched finial for 1003	44.73									A
0995 CL	Shard Cylinder clear finial for 6130	42.69									A
0995 ET	Shard Cylinder etched finial for 6130	52.46									A
1003	Rail, silver, black, white in 6 metre lengths only						18.62				A
1003	Rail, gunmetal, steel grey, taupe, bronze in 6 metre lengths only						25.46				A
1003	Rail, chrome effect in 4 metre lengths only						29.70				A
1011	Rail, silver in 6 metre lengths only						8.42				A
1011	Rail, silver, cut to size						9.19				A
1012	Rail, silver in 6 metre lengths only						8.20				A
1012	Rail, silver, cut to size						8.93				A
1021	Rail, silver in 5 metre or 6 metre lengths only						5.97				A
1021	Rail, silver, cut to size						6.53				A
1021	Rail, white, gold in 6 metre lengths only						12.85				A
1021	Rail, white, gold, cut to size						13.41				A
1025	Rail, silver in 5 metre or 6 metre lengths only						5.97				A
1025	Rail, silver, cut to size						6.53				A
1025	Rail, white, gold in 6 metre lengths only						12.85				A
1025	Rail, white, gold, cut to size						13.41				A
1080	Rail, silver in 5 metre or 6 metre lengths only						7.96				A
1080	Rail, silver, cut to size						8.71				A
1080	Rail, white in 5 metre or 6 metre lengths only						8.39				A
1080	Rail, white, cut to size						9.35				A
1080	Rail, antique bronze, gold, black, cream in 6m. lengths only						17.20				A
1080	Rail, antique bronze, gold, black, cream cut to size						17.99				A
1080	Rail, brushed aluminium in 4 metre lengths only						17.20				A
1080	Rail, brushed aluminium, cut to size						18.00				A
1082	Rail, silver in 5 metre or 6 metre lengths only (System 3000)						13.11				A
1082	Rail, silver, cut to size (System 3000)						14.68				A
1082	Rail, white, in 5 metre or 6 metre lengths only (System 3000)						15.49				A
1082	Rail, white, cut to size (System 3000)						16.00				A
1082	Rail, antique bronze, gold and black in 6 metre lengths only (System 3000)						25.63				A
1082	Rail, antique bronze, gold and black, cut to size (System 3000)						27.16				A
1085	Rail, silver in 4 metre lengths only						17.36				A
1085	Rail, silver, cut to size						20.07				A
1090	Rail, silver in 5 metre or 6 metre lengths only						6.82				A
1090	Rail, silver, cut to size						7.42				A

# Price Index for Rails & Parts

All prices shown  
exclude V.A.T.

Product	Description	Unit Prices					Per Metre Price				Ctgy
		Each	Per 10	Per 100	Other Qty	Price	1m	100m	Other Lgth	Price	
1090	Rail, white in 5 metre or 6 metre lengths only						7.06				A
1090	Rail, white, cut to size						7.78				A
1105	Spacer	0.71	6.75	63.93							A
11210C	Counter sunk screw No.10, 37mm/1 1/2"			20.09							A
1128C	Counter sunk screw No.8, 37mm/1 1/2"			22.99							A
1128R	Round head screw No.8, 37 mm/1 1/2"			22.99							A
1148C	Counter sunk screw No.8, 31mm/1 1/4"			17.38							A
1148R	Round head screw No.8, 31mm/1 1/4"			20.61							A
1200	Rail, white, in 5/6 metre lengths, outers of 10 lengths only						7.23				A
1200	Rail, silver in 6m lengths only						6.84				A
1200	Rail, black, gunmetal, in 6m lengths only, anthracite brushed aluminium and chrome effect in 4m lengths only						12.72				A
1280	Rail, white, in 5/6 m lengths, outers of 10 lengths only						11.35				A
1348R	Round head screw No.8, 44mm/1 3/4"			25.32							A
2004	Bottom weight bar (4 metre length max) 40mm						18.49				A
2006	Aluminium weight bar (4 metre length max) 28mm						13.21				A
2032	Tape spool cassette	10.69	101.81	967.26	250	2290.92					A
2046	Drive pulley	1.95									A
2047	Drive sleeve	3.47									A
2048	Bead chain							257.28			A
2049	Gear drive	25.40	241.99	2199.21							A
2059	Safety clip		9.11								A
2075	Rod cover with ring	1.31	12.53	119.21							A
2081	Take up reel, 2120/2050 systems	11.33	101.67								A
2091	Endcover (for 2135 steel rod)	1.05	9.74	92.72							A
2093	Ring		2.40	22.73							A
2094	Small cord guide/endstop	0.94	8.51								A
2101	Cord guide		22.85	209.04							A
2101	Cord guide, Euroslot sachet of 2	5.39									A
2103T	Transparent loop tape							147.37			A
2104	Cleat, white nylon	3.14	28.57								A
2109	Bottom ring		6.55	59.62							A
2109	Bottom ring, Euroslot sachet of 2	2.15									A
2111	Hexagonal bar								6m	85.51	A
2111	Hexagonal bar, outer of 50 lengths								6m	64.11	A
2116	Velcro profile								5m	89.06	A
2116	Velcro profile, outer of 40 lengths								5m	80.15	A
2131	Short end-cover	1.71	15.30								A
2135	Steel rod								3m	7.87	A
2136	Tubular tape (for 2135 steel rod)							171.63			A
2136CR	Tubular tape, cream							176.25			A
2143	Cord connector	1.68	15.11								A
2144	Cross rail								4m	50.55	C
2145	Glider, wide channel for side rails	1.26	12.08								C
2147	Cord lock	7.54	71.64								A
2151	Rail, silver in 6 metre lengths only						99.14				C
2151	Rail, silver, cut to size						109.09				C
2156	Drive shaft						12.82		6m	69.88	C
2160	Motor	1023.62									C
2162	Tape diverter	3.83									C
2163	Flat drawing tape 6mm							204.01			C
2164	Ring tape								200m	562.57	A
2164T	Transparent ring tape								50m	140.64	A
2179	Endcover for 2211	1.45	13.67								A
2182	Sleeve and pin, pair				2	12.85					C
2187	Connector	41.34									C
2189	Gear, system 2190	166.96									C
2191	Rail, silver, 6 metre lengths only						20.93				C
2191	Rail, silver, cut to size						23.02				C
2191	Rail, white, 6 metre lengths only						22.25				C
2191	Rail, white, cut to size						24.46				C
2191	Rail, bronze, and black in 6 metre lengths only						32.87				C
2191	Rail, bronze, and black cut to size						36.13				C
2192	Belt drive endpiece set	11.89									C
2192W	Belt drive endpiece set, white	12.44									C

# Price Index for Rails & Parts

All prices shown  
exclude V.A.T.

Product	Description	Unit Prices				Per Metre Price				Ctgy
		Each	Per 10	Per 100	Other Qty	Price	1m	100m	Other Lgth	
2193	Belt return set	11.89								C
2193W	Belt return set, white	12.15								C
2196	Lead weight tape							50m	137.53	A
2197	Wooden acorn	2.34								A
2198	Pencil pleat tape							50m	276.32	A
2199	Oval wooden weight section							3m	15.04	A
2211	Velcro profile						32.75	6m	178.54	A
2216	Cord							1000m	254.25	A
2221	Velcro tape							100m	508.52	A
2230	Set, white, grey	24.97								C
2242	Connector	31.86								C
2248	Cross rod							6m	81.77	C
2255	Adjustable brake	16.33	146.91							C
2265	Cord lock system	12.75	115.84							A
2321	Profile, white in 6 metre lengths only						24.15			A
2322	Pin	1.11								A
2323	Shell	1.28								A
2325	Cover	10.07								A
2326	Drive Case 4.1	38.05								A
2327	Adaptor	1.18								A
2328	Adaptor	1.18								A
2329	Adaptor	1.86								A
2333	Wheel for plastic chain	1.78								A
2334	White sleeve for plastic chain	1.78								A
2335	Drive Case 1:1	8.14								A
2336	Support	1.53								A
2337	Endcover	2.37								A
2338	Wire Guides	1.78								A
2339	Cover	2.96								A
2341	Wheel for steel chain	1.79								A
2343	Wall/Ceiling bracket	3.72								A
2344	Grey sleeve for metal chain	1.86								A
2363	Wall/ceiling bracket for 2350	3.80								A
2471	Bottom weight 5"/127mm	1.00		95.90						C
2473	Bottom weight 3½"/89mm	0.80		74.82						C
2479	Link chain 5"/127mm					0.94		500m	417.91	C
2481	Link chain 3½"/89mm					0.94		500m	417.91	C
2539	Touch and close pile section						170.61	25m	47.40	A
2601	Profile only,white					23.75				C
2601	Profile only, silver					23.18				C
2604	Guide	5.20								
2605	Top clip 127mm each, white	0.39		33.84						C
2606	Reducing Top clip 127mm for 2810	0.74		69.69						C
2607	Reducing Top clip 89mm for 2810	0.74		69.69						C
2608	Endstop for 2601	12.26								C
2610	Endstop	1.88								C
2611	Stopper	1.70								C
2612	Brake	3.11								C
2613	Connector	13.99								C
2614	Recess Profile (suspended ceilings)						23.00			C
2615	Recess profile						18.19			C
2616	Bracket, white	3.84								C
2616	Bracket, silver	2.11								C
2618	Shaft	0.93								C
2620	Pilot Runner	6.48								C
2623	Rotation element (123mm)	2.28								C
2624	Rotation element (101mm)	2.28								C
2625	Rotation element (89mm)	2.28								C
2645	Face Fix bracket for 2640/2650	21.88								C
2759	Crossrail, 0.13mm							4m	32.04	C
2813	Top clip 89mm, white	0.39		33.84						C
2821	Spacer (65mm)	0.75								C
2826	Chain connector	1.19	11.45							A
2849	PVC top clip			43.56						C
2865	Twin connector	1.57								C



# Price Index for Rails & Parts

All prices shown  
exclude V.A.T.

Product	Description	Unit Prices				Per Metre Price				Ctgy	
		Each	Per 10	Per 100	Other Qty	Price	1m	100m	Other Lgth		Price
2872	Operating chain, white						2.90		250m reel	716.97	C
3003	Clamp		41.08	369.71							C
3004	Clamp		12.88	116.03							A
3008	Connecting bridge	10.44									A
3016	Endstop	0.45		34.00							A
3016	Endstop, Euroslot sachet of 2	1.77									A
3017	Endstop	0.90		81.36							A
3019	Special 1011/12 screw 12mm/ 1/2"			21.27							A
3020	Hook			40.43							A
3021	Raised head No.6 for 1012 concrete fixing supprt 31mm/1 1/4"			21.91							A
3025	Special 1011/12 screw 19mm/ 3/4"			30.37							A
3030	Pilot runner	1.87		164.22							A
3032	Spring stop		7.48	67.21							A
3033	Clamp for 2900	2.44	21.98								C
3041	Clamp	6.57	65.70								A
3045	Metal overlap	3.86	34.78								A
3055	Hook	0.55	5.31								A
3056	Tape centralizer		10.42								A
3060	Clamp for 1012	0.56	5.62	56.18							A
3062	Connecting bridge for 6243	2.50	25.07	231.97							A
3063	Connecting bridge 1011	2.76	22.72								A
3064	Connecting bridge 1012	2.76	22.72								A
3065	L' bracket A, silver, white with 1 rivetted clamp	8.09									C
3066A	T' bracket A, silver, white with 1 rivetted clamp	38.51									C
3066B	T' bracket A, silver, white with 2 rivetted clamps	38.83									C
3067	Connecting bridge for 6243 profile	3.64									A
3068A	Loop tape							250mtr Reel		577.04	A
3070	Twist eye endstop	0.68	6.04	53.95							A
3071	Screw twist endstop	0.87	8.32								A
3073	Bottom tape adjuster	0.36	2.66								A
3090	Cord						127.23				A
3090A	Cord							500m		603.17	A
3091	Cord, black						178.39				A
3096	Connecting bridge 1090	5.77	51.95								A
3112	Clamp for 1012			55.21							A
3113	5cm spacer 1090		19.21	172.88							A
3133	Plastic bracket cover, black, white, silver, cream, gunmetal, classic gold, steel grey, bronze, antique bronze, sand, taupe	2.42	22.23	204.31							A
3133	Plastic bracket cover, chrome and oak	4.53	42.04	386.13							A
3133L	Long Extension Bracket Cover White	3.24	29.12	275.08							A
3134	2" Extension brackets, silver, white and brown for std systems	3.43	31.57	299.86							A
3134/2	2" Extension brackets, silver, white, cream, classic gold, , gunmetal, black, steel grey, bronze, antique bronze, sand, taupe (for poles)	4.47	41.42	380.72							A
3134 B2	2" Extension brackets, top fix for silver, white, cream, classic gold, gunmetal, black, steel grey, bronze, antique bronze, sand, taupe (for poles)	7.53	73.92								A
3134 B2	2" Extension brackets, top fix for chrome effect and oak (for poles)	10.63	104.86								A
3134/2	2" Extension brackets, chrome effect and oak (for poles)	7.57	73.81	686.59							A
3135	3" Extension brackets, silver, white and brown for standard systems	3.93	38.37	364.49							A
3135/2	3" Extension brackets, silver, white, cream, classic gold, , gunmetal, black, steel grey, bronze, antique bronze, sand, taupe (for poles)	5.32	49.26	452.64							A
3135/2	3" Extension brackets, chrome effect and oak (for poles)	8.03	78.44	729.50							A
3136	4" Extension brackets, silver or white for standard systems	4.04	38.87	369.25							A
3136/2	4" Extension brackets, silver, white, cream, classic gold, , gunmetal, black, steel grey, bronze, antique bronze, sand, taupe (for poles)	6.26	57.96	532.70							A
3136/2	4" Extension brackets, chrome effect and oak (for poles)	10.19	99.54	925.91							A
3137	5" Extension brackets, silver or white for standard systems	6.64	63.13								A
3137	5" Extension brackets, brown for standard systems	9.87	93.66								A
3138	6" Extension brackets, silver or white for standard systems	6.79	64.52								A
3138	6" Extension brackets, brown for standard systems	10.19	97.55								A
3139	8" Extension brackets, silver or white for standard systems	7.52	71.46								A
3139	8" Extension brackets, brown for standard systems	13.11	124.35								A
3135/2616	Extension bracket complete with 2616 bracket and M4 screw silver	6.06	57.58								A
3135/2616	Extension bracket complete with 2616 bracket and M4 screw white	7.80	74.12								A
3136/2616	Extension bracket complete with 2616 bracket and M4 screw silver	6.36	60.49								A
3136/2616	Extension bracket complete with 2616 bracket and M4 screw white	8.10	77.01								A
3137/2616	Extension bracket complete with 2616 bracket and M4 screw silver	8.77	83.37								A
3137/2616	Extension bracket complete with 2616 bracket and M4 screw white	10.51	99.91								A

# Price Index for Rails & Parts

All prices shown  
exclude V.A.T.

Product	Description	Unit Prices					Per Metre Price				Ctgy
		Each	Per 10	Per 100	Other Qty	Price	1m	100m	Other Lgth	Price	
3138/2616	Extension bracket complete with 2616 bracket and M4 screw silver	8.92	84.77								A
	Extension bracket complete with 2616 bracket and M4 screw white	10.67	101.30								A
3139/2616	Extension bracket complete with 2616 bracket and M4 screw silver	9.65	91.70								A
	Extension bracket complete with 2616 bracket and M4 screw white	11.40	108.23								A
3175	Universal nylon bracket for 1090/1200 system	1.23	11.35	67.88							A
3176	Top fix bracket 1090/1200, white	1.23	11.35	67.88							A
3208A	Intermediate pulley, 3000, grey and white	34.68	315.69								A
3208A	Intermediate pulley, 3000, Antique Bronze, black, gold	39.35	365.48								A
3213	Adjustable carrier 3000	2.63		232.47							A
3231	Endfix bracket 3000	9.11	86.42								A
3239	Extension bracket, silver or white	14.56									C
3242	Nylon overlap	2.83	25.00	200.32							A
3242	Nylon overlap, Euroslot sachet of 1	3.63									A
3271	Adjustable bracket base, silver	10.96									A
3271	Adjustable bracket base, white	17.31									A
3271	Adjustable bracket base, brown	12.64									A
3272	Adjustable bracket arm, silver	3.65									A
3272	Adjustable bracket arm, white	10.44									A
3272	Adjustable bracket arm, brown	5.33									A
3273	Adjustable bracket arm, silver	4.75									A
3273	Adjustable bracket arm, white	11.98									A
3273	Adjustable bracket arm, brown	6.43									A
3274	Adjustable bracket arm, silver	4.75									A
3274	Adjustable bracket arm, white	11.40									A
3274	Adjustable bracket arm, brown	6.43									A
3275	7.7cm - 10.7cms, adjustable extension brackets, silver	14.76									A
3275	7.7cm - 10.7cms, adjustable extension brackets, white	27.90									A
3275	7.7cm - 10.7cms, adjustable extension brackets, brown	16.43									A
3276	10cm - 13cm adjustable extension brackets, silver	15.84									A
3276	10cm - 13cm adjustable extension brackets, white	29.44									A
3276	10cm - 13cm adjustable extension brackets, brown	19.21									A
3277	13cm - 16cm adjustable extension brackets, silver	16.11									A
3277	13cm - 16cm adjustable extension brackets, white	28.84									A
3277	13cm - 16cm adjustable extension brackets, brown	19.52									A
3275/3044	Extension bracket, with clamp, silver	14.24									C
3275/3044	Extension bracket, with clamp, white	25.20									C
3276/3044	Extension bracket, with clamp, silver	15.15									C
3276/3044	Extension bracket, with clamp, white	26.48									C
3277/3044	Extension bracket, with clamp, silver	15.15									C
3277/3044	Extension bracket, with clamp, white	25.99									C
3275/3825	Extension bracket, with clamp, silver	13.02									C
3275/3825	Extension bracket, with clamp, white	23.98									C
3275/3825	Extension bracket, with clamp, brown	14.42									C
3276/3825	Extension bracket, with clamp, silver	13.94									C
3276/3825	Extension bracket, with clamp, white	25.26									C
3276/3825	Extension bracket, with clamp, brown	16.74									C
3277/3825	Extension bracket, with clamp, silver	14.22									C
3277/3825	Extension bracket, with clamp, white	24.76									C
3277/3825	Extension bracket, with clamp, brown	17.08									C
3288	Endpiece set 3000, grey	26.38			25	609.53					A
3288	Endpiece set 3000, white	29.11			25	649.18					A
3288	Endpiece set 3000, gold/black/antique bronze	32.31			25	746.44					A
3289	Endpiece set, grey	30.16									A
3289	Endpiece set, white	32.08									A
3311	Cord				100m	75.00					A
3511	Glider			11.06	25000	2219.74					A
3532	Glider			23.45	5000	939.76					A
3533	Glider			12.40	25000	2480.04					A
3533	Glider, sachets of 25 x 25	76.62									A
3533	Glider, Euroslot sachets of 25	4.06									A
3533/6146	Glider with hook				20	9.63					A
3534	Glider in strip form				1000	106.09					A
3548	Retrofit glider				25	5.73					A
3548	Retrofit glider			20.90	1000	208.54					A
3562	Standard tape						214.99				A
3570	Rotating glider		2.72	23.83							A

# Price Index for Rails & Parts

All prices shown  
exclude V.A.T.

Product	Description	Unit Prices					Per Metre Price				Ctgy
		Each	Per 10	Per 100	Other Qty	Price	1m	100m	Other Lgth	Price	
3571	Hook			10.92	35000	3208.16					A
3571	Hook, sachet of 25 x 25	72.93									A
3571	Hook, Euroslot sachet of 25	3.70									A
3579	Glider/hook	0.23	2.07	19.82							A
3579	Glider/hook, Euroslot sachet of 25	6.05									A
3580	Glider/hook			44.05	5000	2101.35					A
3582	Plastic hook			9.70							A
3582	Plastic hook, sachets of 25 x 25	81.45			625	81.44					A
3582	Plastic hook, outer 20000				20000	1722.67					A
3582	Plastic hook, outer 1000				1000	90.67					A
3582	Plastic hook, Euroslot sachets of 25				25	3.41					A
3599	2 prong hook			15.21	25000	2896.79					A
3599	2 prong hook, sachets of 25 x 25	116.22									A
3599	2 prong hook, Euroslot sachets of 25	5.00									A
3600	Picture hanging set	20.51									A
3602	Wall support 1080, grey	4.43	42.02								A
3602	Wall support 1080, white	4.65	42.19								A
3603	Top fix bracket, white	1.65	14.98	136.43							A
3603	Top fix bracket, Euroslot sachets of 2, white	4.28									A
3604	Nylon Corner Piece (White Only)	3.18									A
3605	Endcover 1080, white	2.29	20.87	198.78							A
3606	Snap fastener 1080	1.16	9.11								A
3610S	Hanger rod assembly 2'	22.37									A
3610S	Hanger rod assembly 3'	24.89									A
3610S	Hanger rod assembly 4'	30.09									A
3611	Ceiling stud 1085	2.03									A
3612	Sleeve for 3610	4.49									A
3615	Clamp/insert for pelmet system	1.00									A
3618	Metal wall support	6.46	58.12								A
3620	Connecting bridge	12.20	114.38								A
3626	Return fixing bracket	3.89	34.94								A
3630	White universal nylon bracket	1.58	12.57	114.42							A
3630	Universal nylon bracket, white, black Euroslot sachet of 2	4.12									A
3630	Universal nylon bracket, black, gold	1.77	15.87								A
3634	Height adjuster	3.56									A
3637	Cord						64.66				A
3637A	Cord							500m	291.06		A
3638	Re-inforced corner piece, grey, white	2.67	24.36	221.90							A
3639	Hanger rod assembly complete	20.61									A
3639	Hanger rod assembly complete, per extra foot	2.40									A
3648	Eyelet for 3638	0.44	3.83	34.40							A
3652	Wall support, grey	5.55									A
3655	Long universal bracket	2.69	25.58	232.79							A
3657	Connecting bridge 3600	4.05									A
3660	Extra long universal bracket	3.35									A
3660	Extra long universal bracket, Euroslot sachet of 1	4.37									A
3663	Profile hook	3.09									A
3666	Cord Tidy	1.09	9.90	90.00							A
3667	Endcover/stop, white, grey	1.25	12.04	114.83							A
3667	Endcover/stop, white, grey, Euroslot sachets of 2	3.50									A
3802	Connecting bridge	13.46									A
3825	Clamp		19.12	183.01							A
3826	Top fix bracket	1.26	11.47	103.29							C
3832	Twist clamp	2.41									A
3833A	Intermediate pulley (White)	49.56									A
3833A	Intermediate pulley - Black, Antique Bronze, Gold, Grey	54.20									A
3836	Face fix bracket, White	2.60									A
3841	Rail, silver in 6 metre lengths only						15.33				A
3841	Rail, silver, cut to size						17.03				A
3841	Rail, white in 6 metre lengths only						17.00				A
3841	Rail, white, cut to size						18.89				A
3841	Rail, antique bronze, gold and black in 6 metre lengths only						30.22				A
3841	Rail, antique bronze, gold and black, cut to size						31.91				A
3842	Endcap for 3840 Hand, white.	4.17									A
3842	Endcap for 3840 Hand, silver, gold, black, antique bronze	5.84									A

# Price Index for Rails & Parts

All prices shown  
exclude V.A.T.

Product	Description	Unit Prices				Per Metre Price				Ctgy
		Each	Per 10	Per 100	Other Qty	Price	1m	100m	Other Lgth	
3845	Endpiece set, white/grey	16.52								A
3845	Endpiece set, gold	20.37								A
3845	Endpiece set, black/antique bronze	22.95								A
3846	Endpiece set, white, grey	22.85								A
3914	Bracket for return profile	13.66								A
3915	Endpiece set				20	373.99				A
3915	Endpiece set				50	841.84				A
3916	Pilot runner for multi-stack system	1.58	14.10							A
3917	Pilot runner	2.16		206.02						A
3922	Roller gliders in strip form, outer of 1000				1000	427.72				A
3922	Roller gliders in strip form, outer of 8000				8000	2955.29				A
3929A	Intermediate pulley	53.65	510.77							A
3932	Spring stop	0.77	7.35							A
3933	Click glider in strip form, outer of 1000				1000	271.75				A
3935	Overlap arm (System 3900)	20.19	192.42							A
3936	Overlap arm (System 3900)				20	203.73				A
3936A	Combination overlap with 'S' hook attachment 3949	13.67	130.14							A
3939	Pilot runner	1.84		176.58						A
3942	Intermediate stop	3.09	30.01							A
3947	Pair of magnetic gliders		87.50							A
3949	Combination for overlap 3936A and 3935A	2.92	27.78							A
3975	Overlap for pulling by hand (1280)	18.52	176.34							A
3982	Rail, white, available in 5 metre or 6 metre lengths in outers of 10 lengths only (System 3900)						17.78			A
3985	Endcover in white 1280			197.20						A
3986	Endcover for 1200, white, grey, dark grey, black			119.31						A
4221	Bottom weight bar, white, silver or black						17.72			C
4223	Plastic strip with adhesive 12mm						3.12			C
4226	Standard adhesive tape, 30mm						5.11			C
4245	Extension bracket	12.01								C
4845	Metal bead chain (2020/2120)							125m	456.17	A
4845BR	Metal bead chain, brass (2020/2120)							125m	857.98	A
5118	Wedge	4.89								C
5130	Drive belt for 2190/2195						11.37			C
5190	Motor 100-250V AC with 5 Metre lead	231.59								A
5301	Rail, silver in 6 metre lengths only						45.54			C
5301	Rail, white in 6 metre lengths only						47.96			C
5302	Drive belt						18.30			C
5304	Drive set, white, grey	101.68								C
5310	Endset, return, white, grey	87.93								C
5312	Endstop	11.99								C
5317	Master carrier set	42.45								C
5318	Motor support	14.21								C
5319	Connecting bridge	31.86								C
5320	Clamp	4.37								C
5321	Master pilot	47.75								C
5360	Motor	2438.74								C
5670	Overlap	59.20								C
5682	Hood	13.99								C
5684	Connector	30.00								C
5736	Surface relay socket	137.53								C
5778	Special plug for cable 5779, pair	3.29			2	6.59				C
5779	4 core low voltage connecting cable						4.50			C
5782ST	Single Channel radio handset white	95.76								C
5784ST	Multi channel radio handset white	126.21								C
5805	Motor for 5800	9254.70								C
5806	Pilot runner	29.09								C
5809	Roller glider		98.39							C
5810	Profile						102.78			C
5811	Overlap	199.68								C
5813	Floor frame	1252.24								C
5814	Cable						31.14			C
5815	Cord guide return	294.20								C
5816	Cord guide	384.87								C
5824	Endstop	31.64								C

# Price Index for Rails & Parts

All prices shown  
exclude V.A.T.

Product	Description	Unit Prices					Per Metre Price				Qty
		Each	Per 10	Per 100	Other Qty	Price	1m	100m	Other Lgth	Price	
5829	2 hole fixing plate	9.09									C
5834	Double pilot	213.30									C
6007	Endstop, silver	0.64	6.09								A
6007	Endstop, white	0.82	7.78								A
6021	Rail, white, in 5/6 metre lengths, outers of 10 lengths only						10.76				C
6024	Panel glide connecting bridge	11.61									C
6053	Spring stop	1.26	11.67								A
6063	Overlap	10.00	90.92	849.79							A
6063R	Overlap arm with rollers for 6120	17.30									A
6064	Screw twist endstop	1.22	10.32								A
6065	Twist eye endstop	1.07	9.79	90.06							A
6070	Cord 6200/6370							356.72			C
6079	Overlap	32.54									C
6083	Glider			20.90							A
6083	Glider, sachets of 25 x 25	147.37									A
6083	Glider, Euroslot sachets of 25	6.02									A
6086	Spring stop	1.78	16.70	151.71							A
6094	Roller glider with hook		29.27	278.50							A
6096	Strip gliders, outer 1000				1000	168.12					A
6098	Roller glider with eye		24.69	234.21							A
6098W	Wave roller glider (80mm)								50m	2561.64	A
6101	Rail, white in 4.5m, 4.75m, 5m, 5.25m, 5.5m, 6m, 6.75m lengths only						29.64				A
6101	Rail, silver in 4.5m, 4.75m, 5m, 5.25m, 5.5m, 6m, 6.75m, 7.5m lengths only						26.36				A
6101	Rail, black, 6m lengths only						26.10				A
6101	Rail, gunmetal, steel grey, bronze, antique bronze 6m lengths only						38.25				A
6101	Rail, chrome, 4m lengths only						55.98				A
6103	Rail, gunmetal, , steel grey, bronze, antique bronze, sand, taupe in 6 metre lengths only Classic Gold max (4m)						41.18				A
6103	Rail, silver, white, cream, black in 6 metre lengths only						28.13				A
6103	Rail, chrome effect (4m max), , oak, (5m max.)						61.07				A
6106	Rail, silver, white, cream, black in 6 metre lengths only						36.92				A
6106	Rail, gunmetal, , steel grey, bronze, antique bronze, sand, taupe in 6 metre lengths only, classic gold (4m max)						50.73				A
6106	Rail, chrome effect (4m max), oak, (5m max.)						68.50				A
6110	Dustcover, white						2.93				A
6122	Endstop			259.99							A
6124	Twist fixing plate	4.63									A
6137	Ceiling fix plate, single, silver	6.44									A
6137	Ceiling fix plate, single, white	7.06									A
6138	Ceiling fix plate, double, silver	7.17									A
6138	Ceiling fix plate, double, white	7.87									A
6138P	Ceiling support, black, white, cream, silver, gunmetal, classic gold, chrome effect, diva gold, steel grey, bronze, antique bronze, sand, taupe and oak	8.00	71.99								A
6138P/2	Ceiling support, black, white, silver, cream, gunmetal, classic gold, chrome effect, diva gold, steel grey, bronze, antique bronze, sand, taupe and oak for 6120	15.97	143.99								A
6141	Insert		22.63	208.50							A
6143	Glider			16.62	1000	155.16					A
6146	Hook			17.54	12	2.59					A
6147	Glider hook				20	11.21					A
6147	Glider hook				500	224.44					A
6147	Glider hook				8000	3006.78					A
6148	Glider (yellow)				1000	249.59					A
6149	Lead glider (blue)			61.36							A
6160	Track insert	15.21									A
6165	Intermediate Pulley for 6120, black, cream, silver, classic gold, gunmetal, chrome, white, diva gold, steel grey, bronze, antique bronze, sand, taupe, oak	58.96	589.60								A
6175	Mini hanger, silver	22.01									A
6175	Mini hanger, white	24.33									A
6187	Dummy ceiling support sleeve, silver	8.00									A
6187	Dummy ceiling support sleeve, white	9.23									A
6188	Ceiling support	13.43									A
6188	Ceiling support	14.84									A
6188	Ceiling support	16.61									A
6188	Ceiling support	21.03									A

# Price Index for Rails & Parts

All prices shown  
exclude V.A.T.

Product	Description	Unit Prices					Per Metre Price				Ctgy
		Each	Per 10	Per 100	Other Qty	Price	1m	100m	Other Lgth	Price	
6190	Hanger rod assembly, complete including 6192 ceiling support and 6191 rod 61 cm (2') silver	28.56									A
6190	Hanger rod assembly, complete including 6192 ceiling support and 6191 rod 61 cm (2') gold	34.40									A
6190	Hanger rod assembly, complete including 6192 ceiling support and 6191 rod 61 cm (2') white	31.60									A
6190	Hanger rod assembly, complete including 6192 ceiling support and 6191 rod 61 cm (2') chrome effect	45.18									A
6190	Hanger rod assembly, complete including 6192 ceiling support and 6191 rod 91 cm (3') silver	32.85									A
6190	Hanger rod assembly, complete including 6192 ceiling support and 6191 rod 91 cm (3') gold	39.60									A
6190	Hanger rod assembly, complete including 6192 ceiling support and 6191 rod 91 cm (3') white	35.44									A
6190	Hanger rod assembly, complete including 6192 ceiling support and 6191 rod 91 cm (3') chrome effect	55.80									A
6191	Hanger tube, silver						14.20				A
6191	Hanger tube, gold						17.83				A
6191	Hanger tube, chrome effect						35.42				A
6191	Hanger tube, white						15.78				A
6192A	Ceiling support, 50mm complete with stud 6193 and 2 grub screws, silver	17.52									A
6192A	Ceiling support, 50mm complete with stud 6193 and 2 grub screws, gold	21.70									A
6192A	Ceiling support, 50mm complete with stud 6193 and 2 grub screws, white	19.21									A
6192A	Ceiling support, 50mm complete with stud 6193 and 2 grub screws, chrome effect	27.33									A
6192B	Ceiling support, 100mm complete with stud 6193 and 2 grub screws, silver	25.34									A
6192B	Ceiling support, 100mm complete with stud 6193 and 2 grub screws, white	27.78									A
6193	Stud for ceiling support	2.60									A
6194	Insert	2.41									A
6197	Hanger joint sleeve, silver	16.17									A
6197	Hanger joint sleeve, white	17.78									A
6199	Internal connecting bridge	11.06									A
6203	Connecting bridge	24.78									C
6206	Endpiece set, grey	134.76									C
6209	Clamp	7.36	69.88								C
6210	Rail, silver in 4 metre, 5 metre and 6 metre lengths only						34.77				C
6210	Rail, silver, cut to size						37.93				C
6214	Adjustable pilot	10.44									C
6224	Nylon clamp	12.71									C
6226	End support	5.65									C
6227	Master runner	10.44									C
6228	Double fixing plate	5.75									C
6230	Mask	17.19									C
6243	Rail White in 6 metre lengths only						10.73				A
6268	Hanger for recess profile 2748 or profile 2948	9.97									C
6283	Roller glider		15.33	145.37							A
6288	Plastic overlap arm	3.17	28.63	257.50							A
6290	Rail, White, in 5/6m lengths, outers of 10 lengths only						6.55				A
6345	Wave glider-cord, 60mm pitch, 50m rolls only								50	767.01	A
6346	Wave glider-cord, 80mm pitch, 50m rolls only								50	583.92	A
6349	Wave curtain tape, 50m, 100m rolls only							256.33	50	131.28	A
6354	Pilot runner for set 6119 (System 6120)	5.49	52.22								A
6363	Wave Iron-on hemming tape							182.50			A
6364	Extension arm	4.46	40.13								A
6365	Hanger	3.71	33.45								A
6366	Draw rod carrier	7.04	63.37								A
6367	Master carrier	2.23	20.07								A
6368	Carrier	2.23	20.07								A
6369	Insert for face fixing 6370	4.50									C
6371	Rail, silver in 4 metre, 5 metre and 6 metre lengths only						28.76				C
6371	Rail, silver, cut to size						33.23				C
6376	Connecting bridge	14.97	142.23								C
6377	Endpiece set, grey	35.99	342.73								C
6398	Clip	0.87	7.86								C
6501	V-hanger, silver	66.86			metre drop	24.85					A
6501	V-hanger, white	73.56			metre drop	27.33					A
6471	Endcover White	1.12									A
6471	Endcover Grey	1.04									A

# Price Index for Rails & Parts

All prices shown  
exclude V.A.T.

Product	Description	Unit Prices				Per Metre Price				Qty
		Each	Per 10	Per 100	Other Qty	Price	1m	100m	Other Lgth	
6503	Wall bracket complete, white, 25mm long with 50mm projection	13.88								A
6503	Wall bracket complete, silver, 25mm long with 50mm projection	12.60								A
6503	Wall bracket complete, white, 50mm long with 50mm projection	18.49								A
6503	Wall bracket complete, silver, 50mm long with 50mm projection	16.33								A
6503	Wall bracket complete, white, 100mm long with 50mm projection	22.92								A
6503	Wall bracket complete, silver, 100mm long with 50mm projection	20.41								A
6503	Wall bracket complete, white, 200mm long with 50mm projection	32.07								A
6503	Wall bracket complete, silver, 200mm long with 50mm projection	28.92								A
6503	Wall bracket complete, white, 50mm long with 100mm projection	27.28								A
6503	Wall bracket complete, silver, 50mm long with 100mm projection	24.30								A
6503	Wall bracket complete, white, 100mm long with 100mm projection	37.80								A
6503	Wall bracket complete, silver, 100mm long with 100mm projection	34.36								A
6503	Wall bracket complete, white, 75mm long with 150mm projection	66.23								A
6503	Wall brackets complete, silver 75mm long with 150mm projection	60.21								A
6511W	White cover for 6527	15.65								A
6512	Connecting bridge, silver	22.12								A
6512	Connecting bridge, white	25.17								A
6514M	T-junction, single, silver	10.21								A
6514M	T-junction, single, white	12.12								A
6519	Silver V-hanger rod						10.05			A
6521	External bridge 6103, silver	64.22								A
6521	External bridge 6103, white	68.44								A
6524A	Diagonal fixing support, silver	40.97								A
6524A	Diagonal fixing support, white	49.21								A
6525A	Double T-junction, silver	14.07								A
6525A	Double T-junction, white	16.26								A
6575	Cord tensioner	239.66								C
6578	Floor plate	156.65								C
6609	Wall support, white	7.30								A
6609	Wall support, grey,	7.30								A
6611	Endcover, grey	5.65								A
6611	Endcover, white	6.37								A
6620	Wall bracket 6103, grey	13.12	118.66							A
6625A	Fixing sleeve complete for V-hanger/diagonal support, silver	27.16								A
6625A	Fixing sleeve complete for V-hanger/diagonal support, white	30.66								A
6628	V-hanger track insert	20.59								A
6630	Endcover, white, black, grey, gold, chrome effect	4.34	40.05	367.97						A
6630	Endcover, gunmetal	7.51	71.23	676.71						A
6632	Internal connecting bridge 6103	8.65								A
6635	Internal connecting bridge	17.94								A
6639	Track insert	2.56								A
6655	Wall Support	29.69								A
6663	Wall brackets connector plate complete	35.90								A
6666	Safety connecting bridge	45.81								A
6671	Washer insert for countersunk screw	1.79								A
6672	Cover for 6671	2.26								A
6675	Safety Device	37.51								A
6677	V-Hanger safety device	57.50								A
6739	Machine screw M4 6mm/ 1/4"			14.71						A
6748	Machine screw M4 8mm/ 5/16"			20.50						A
6770	Locking pin	1.45								A
6771	Vine eye	1.68								A
6784	Machine screw for 6639			15.26						A
6789	Grub screw	0.25								A
6798	Machine screw M4 12mm/ 1/2"			21.50						A
6835A	Round head No. 4 screw 12mm/ 1/2"			8.23						A
6835B	Round head No. 4 screw 25mm/ 1"			14.21						A
6952	Magnetic handle holder	11.16								C
7002	Rail protector	5.33								A
8003	Bottom bar (16mm)					37.59		5m		C
8004	Bottom bar (25mm)					38.88		5m		C
8013	Bottom bar clip (25mm)	1.29	11.76							C
8235	Wire base short	2.03								C
8236	Wire base long	2.12								C
8237	Wire holder	2.03								C

# Price Index for Rails & Parts

All prices shown  
exclude V.A.T.

Product	Description	Unit Prices				Per Metre Price				Ctgy
		Each	Per 10	Per 100	Other Qty	Price	1m	100m	Other Lgth	
8249A	Locking ring	0.59								C
8920	Universal bracket for 8910	6.73								C
9060	Motor, white, grey	720.04								C
9063	Radio module set, white, grey (compatible with 0450)	157.04								C
9063EL	Radio module set, white, grey (compatible with 9940)	157.04								C
9068	Single channel receiver	362.74								C
9090	Motor for 2650/2950	662.88								C
9091	Motor with receiver for 2650/2950	753.56								C
9944	Single channel receiver, non latching	278.15								C
9945	Single channel receiver, latching	251.49								C
9946	Single channel wall switch	146.40								C
9947	Control unit DC 24V	164.35								C
9948	Single channel programmable wall switch with timer	366.02								C
9952	Hard wired timer switch	221.91								C
9960	Move server set (includes 1 x transmitter stick)	964.00								C
9961	Move transmitter stick	352.67								C
10040	Power supply set for 2650, 2950	115.63								C
10048	Power cable with plug for 5090, 2650 and 2950	6.76								C
10075	Lead weight						3.24			A
10076	Fabric weight white	7.98								A
10076/1	Fabric weight s/steel	7.59								A
10122	Profile cut to size, white, (for System 2700, 2 channel)						33.64			C
10123	Profile cut to size, white, (for System 2700, 3 channel)						54.29			C
10124	Profile cut to size, white, (for System 2700, 4 channel)						57.81			C
10125	Profile cut to size, white, (for System 2700, 5 channel)						62.79			C
10132	Profile cut to size, white (for System 2730, 2 channel)						26.53			C
10133	Profile cut to size, white (for System 2730, 3 channel)						41.65			C
10134	Profile cut to size, white (for System 2730, 4 channel)						56.76			C
10135	Profile cut to size, white (for System 2730, 5 channel)						71.88			C
10136	Top fix bracket for 2700, 2 channel profile only	3.28	31.22							C
10137	Top fix bracket for 2700, 3, 4 and 5 channel profiles	3.83	36.43							C
10140	Angle with screw	1.38								C
10142	Cover for 2 channel 2700 profile	2.02								C
10143	Cover for 3 channel 2700 profile	2.03								C
10144	Cover for 4 channel 2700 profile	2.08								C
10145	Cover for 5 channel 2700 profile	2.91								C
10146	Angle with screw	1.38								C
10148	Eyelet with screw	1.82								C
10150	Pilot runner with screw for 2700	3.62								C
10153	cord guide for 3 channel 2700 profile	7.34								C
10154	cord guide for 4 channel 2700 profile	7.40								C
10155	cord guide for 5 channel 2700 profile	8.72								C
10156	End stop with screw for 2700	2.86								C
10157	Wedge for 2700 recess profiles	1.94	18.39							C
10172	Recess profile, 2 channel, (for System 2700)						29.53			C
10173	Recess profile, 3 channel, (for System 2700)						29.53			C
10174	Recess profile, 4 channel, (for System 2700)						29.53			C
10175	Recess profile, 5 channel, (for System 2700)						29.53			C
10177	Connecting bridge for 2730	5.27								C
10180	Carrier assembled, flexible, (for system 2730)						38.10			C
10200	Roller for 2700 carrier	1.28								C
10230	Carrier assembled, white, (for system 2700)						35.48			C
10234	Glass weight bar 16mm	1.46								C
10252	2700 carrier end cover left	0.72								C
10253	2700 carrier end cover right	0.72								C
10269	Face fix bracket, 60mm, white, (for System 2730)	4.10	39.06							C
10270	Face fix bracket, 80mm, white, (for System 2730)	4.62	43.84							C
10271	Face fix bracket, 100mm, white, (for System 2730)	5.12	48.62							C
10272	Face fix bracket, 60mm, white, (for System 2730)	5.62	53.41							C
10281	Slot nut (for System 2730)		15.12							C
10297	Solar Sensor	343.85								C
10298	Sensor	310.71								C
10300	Single channel hand held remote	204.48								C
10302	5 + 1 channel hand held remote	204.48								C
10303	10 + 2 + 1 channel hand held remote	249.22								C



# Price Index for Rails & Parts

All prices shown  
exclude V.A.T.

Product	Description	Unit Prices				Per Metre Price				Ctgy	
		Each	Per 10	Per 100	Other Qty	Price	1m	100m	Other Lgth		Price
10399	Design Fascia for 2730, white				per system	3.65	22.33				C
10400	Cord retainer	0.38									E
10430	Draw rod 50cm aluminium	8.64									C
10430	Draw rod 50cm white	9.37									C
10431	Draw rod 75cm aluminium	10.06									C
10431	Draw rod 75cm white	11.23									C
10432	Draw rod 100cm aluminium	11.40									C
10432	Draw rod 100cm white	12.82									C
10433	Draw rod 125cm aluminium	12.42									C
10433	Draw rod 125cm white	14.07									C
10434	Draw rod 150cm aluminium	13.33									C
10434	Draw rod 150cm white	15.19									C
10530	Chain for 4910 roller blind								150m	340.20	A
10530BR	Brass chain for 4910 roller blind								125m	299.25	A
10534	Continuous headrail profile for 4900, 4910, 4960 silver, white (per m width)	17.69									A
10539	Optional click bracket for fixing continuous headrail 10534	4.21									C
10542	Drive side bracket for 4910 white	3.57									C
10543	Click side bracket for 4910 white	3.34									C
10545	Spring clutch set for 4910 system	59.55									C
10546	Spring clutch set for 4910 system	59.55									C
10547	Spring clutch set for 4910 system	66.57									C
10548	Spring clutch set for 4910 system	66.57									C
10549	Spring clutch set for 4910 system	80.90									C
10551	Spring clutch set for 4910 system	59.55									C
10552	Spring clutch set for 4910 system	59.55									C
10553	Spring clutch set for 4910 system	66.57									C
10554	Spring clutch set for 4910 system	66.57									C
10555	Spring clutch set for 4910 system	80.90									C
10574	Bracket cover for 4900, 4910, 4960 white	2.10									C
10575	Bracket cover for 4910, 4960 white	2.11									C
10632	Intermediate bracket cover for 4900, 4910, 4960 white	5.04									C
10633	Rectangular bottom bar for 4900, 4910, 4960 silver, white (per m width)	11.17									C
10634	Oval bottom bar for 4900, 4910, 4960 silver, white (per m width)	11.17									C
10635	End cover for rectangular bottom bar 10633 silver, white	1.23									C
10637	End cover for oval bottom bar 10634 silver, white	1.23									C
10639	End cover for round bottom bar 4221 silver, white	0.94									C
10645	Pull grip set	11.88									C
10697	Spring clutch set for 4910 system	80.90									C
10698	Spring clutch set for 4910 system	80.90									C
10699	Spring clutch set for 4910 system	80.90									C
10700	Spring clutch set for 4910 system	80.90									C
10707	Cushion, white 4900/4910	1.46									C
10815	Cover, white, grey	1.38									A
10816	Motor cover, white, grey	1.05									C
10817	Motor case holder, white, grey	7.30									C
10819	Belt return set, white, grey	11.66									C
10820	Overlap arm, straight	4.41									C
10821L	Overlap arm, bent	4.73									C
10821	Overlap arm, bent	4.73									C
10822	Master carrier set	5.04									C
10823	Belt connector arm	1.62									A
10824	Belt connector pin	1.62									A
10825	Drive belt						4.98	498.00			A
10826	Overlap support set	5.57									C
10831	Connecting bridge 5600	12.23									C
10836	Mask pair stack	1.56									A
10837	Pilot runner arm	2.10									C
10838	Pilot runner set	23.73									C
10840	Roller Glider	2.63	25.73	240.45							C
10844	Wave endstop (motor), white, grey	1.47									C
10845	Wave master carrier, single stack (80mm)	13.13									C
10850	Rail, silver, 6 metre lengths only						15.17				C
10850	Rail, white, 6 metre lengths only						15.33				C
10850	Rail, silver, cut to size						16.70				C
10850	Rail, white, cut to size						16.85				C
10852	Wave roller glider cord (80mm), 6.5mm channel								56m	2743.02	C

# Price Index for Rails & Parts

All prices shown  
exclude V.A.T.

Product	Description	Unit Prices				Per Metre Price				Ctgy
		Each	Per 10	Per 100	Other Qty	Price	1m	100m	Other Lgth	
10854	Wave overlap support arm	2.14								A
10856	Wave end stop (return end), white, grey	2.36								C
10862	Recess profile for 5600, white, 6 metre lengths only						16.96			C
10862	Recess profile for 5600, white, cut to size						18.64			C
10863	Recess mask, motor, white	4.04								C
10864	Recess mask, belt return, white	3.52								C
10865	Mounting support plate	1.73								C
10867	M4 X 16 Pan Head Screw for 5100	0.07								A
10869	Wave roller glider cord (60mm), 6.5mm channel							43m	2668.37	C
10886	Wave overlap arm, pilot runner set	6.62								C
10887	Wave overlap arm set	6.77								C
10905	Wave glider cord (80mm), 6.5mm channel							50m	1371.00	A
10906	Wave glider cord (60mm), 6.5mm channel							50m	1644.93	A
10924	Wave glider support	1.70								A
10925	Rail, white 5.7 metre lengths only (System 5100)							5.7m	57.46	C
10925	Rail, white, cut to size (System 5100)						10.08			C
10926	Clamp	2.45								C
10931	Roller Glider for 10925	0.37								A
10933	Belt return & Motor Holder Set	6.92								A
10936	Overlap Arm Set	10.65								A
10940	Belt Return for 5100	5.81								A
10943	Connecting bridge for 5100	13.79								A
10945	Endstop for 5100	1.50								A
10946	1 Channel Transmitter White	46.85								A
10947	2+1 Channel Transmitter White	57.49								A
10948	6+1 Channel Transmitter White	57.49								A
10949	1 Channel Wall Transmitter White	38.86								A
10950	2+1 Channel Wall Transmitter White	57.49								A
10951	5+1 Channel Wall Transmitter White	57.49								A
11092	Timer White	113.40								A

# Tools & Packaging

All prices shown  
exclude V.A.T.

Product	Description	Unit Prices					Per Metre Price				Ctgy
		Each	Per 10	Per 100	Other Qty	Price	1m	100m	Other Lgth	Price	
0513	Bending kit for 7103/7109 incl. fillers, blocks, arms and rings for system 1012	256.53									E
0538	Bending Kit for 7103/7109 incl fillers, blocks, arms and rings for system 3840	149.23									E
0539	Crimping tool	284.00									E
0545	Bending Kit for 7103/7109 incl. fillers, blocks, arms and rings for system 3900	301.45									E
0547	Bending block set (6103)	322.39									E
0548	Bending block set (2191)	332.31									E
0587	2.5mm Allen Key for Metropole	0.08									E
0650	Bending kit for 7103/9 including filler set, rings and blocks for 1200	164.10									E
0679	Joining pliers for bead chain 4845	113.80									E
0722	2mm Allen Key	0.47									E
0997	Limit setting lead	26.25									E
5651	Programming Cable for 5400	73.32									E
7004	Cording needle	1.68									E
7037	Bending fillers 6100	34.06									E
7099	Hook for 2147	0.37									E
7103	Portable hand operated bending tool for 1080, 1200, 3000, 1280 and 3900, complete with sets of fillers	1105.28									E
7109	Portable electrically operated bending tool for 1080, 3000, 1280 and 3900 complete with sets of fillers	1299.80									E
7223	Tongs for connector 2865	357.83									E
7230	Slotting tool for wide channel profiles	105.11									E
7432	Bending ring 15cm 1003 for 7103/9	57.95									E
7550	Centre tool	75.14									E
7802	Filler set 3840 for 7103/9, 200 cm	137.23									E
7803	Filler set 3900 for 7103/9, 200 cm	154.16									E
7803A	Filler set 3900 for 7103/9, 70 cm	80.60									E
7805	Filler set 3000 for 7103/9, 200 cm	244.05									E
7805A	Filler set 3000 for 7103/9, 70 cm	126.69									E
7806	Filler set 1080 for 7103/9, 200 cm	70.16									E
7806A	Filler set 1080 for 7103/9, 70 cm	34.16									E
7809	Filler set 1012 at 200cm for 7103/9 and 7100	68.87									E
7844	Filler set 1280 for 7103/9, 70cm	107.88									E
7844A	Filler set 1280 for 7103/9, 200cm	198.65									E
7845	Filler set 1200	71.40									E
7848	Filler set 1003 for 7103/9, 70cm	39.39									E
10480	Child safety device (metal chain) for 2320/2330	8.83									E
10481	Child safety device (plastic chain) for 2320/2330/2810 (127mm only)	8.83									E
10482	Child safety device (metal chain) for 4905/4910/8300	8.83									E
10536	Joining pliers for 10530 chain (4910) also require 10537	61.23									E
10537	Joining pliers for 10530 chain (4910) also require 10536	61.23									E
80018	Slotting tool	414.69									E
B5	Bending block for 6100	387.54									E
SF	Silicone fluid, litre	49.50									E
SL1080	Sleeving 1080, reel	26.49									E
SL1080W	Sleeving 1080W, reel	38.13									E
SL1090	Sleeving 1090, reel	33.17									E
SL1090W	Sleeving 1090W, reel	37.30									E
SL3000	Sleeving 3000, reel	41.75									E
SL3000W	Sleeving 3000W, reel	48.34									E
SLP	Sleeving plain 2" x 300 gauge, reel	17.90									E
HTSAL	Top s/a label			41.66							E
HBSAL	Bottom s/a label			29.77							E
CIAL	Colour indication s/a label (mixed - please specify)			4.46							E
CSIAL	Size indication s/a label (mixed - please specify)			4.46							E
HINL	Instruction leaflet			13.44							E
HCPA	38mm x 38mm acetate sleeving, roll										E
HWPE	White plastic endcaps				pair	1.76					E
CTSAL	Top s/a label			41.66							E
CBSAL	Bottom s/a label			36.70							E
CINL	Instruction leaflet			13.44							E
CCPA	35mm x 50mm acetate sleeving, roll										E
CWPE	White plastic endcaps				pair	1.76					E

## Application Chart for Silent Gliss® Switches, Remote Control and Multiple Operation of Motorised Systems

Motor Number	Fixed Switch (Hard wired)	Radio Control System 0450		Radio Control System 9940			Timer and Controls	System
		Hand Held Remotes	Wall Switches	Move Server Set	Hand Held Remotes	Wall Switches & Light Sensors		
2160	0615/6/7/8/9 Latching	Remote 0915/0939 Receiver 0919	Wall Switch 0913/0914 Receiver 0919	9960, 9961	Remote 10300/10302/10303 Receiver 9068/9944/9945	Wall Switch 9943/9946/9948 Light Sensor 10297 Receiver 9068/9944/9945	9952 0570	2195
10322/10323/10522/10523	Motor 10522/10322 0615/6/7/8/9 Latching	Motor 10322/10522 Remote 0915/0939 Receiver 0919	Motor 10322/10522 Wall Switch 0913/0914 Receiver 0919	9960, 9961	Motor 10323/10523 Remote 10300/10302/10303 Receiver Integrated	Motor 10323/10523 Wall Switch 9943/9946/9948 Light Sensor 10297 Receiver Integrated	9952 0570	2350
9090/9091/9091EL	Motor 9090 0613 5 Position	Motor 9091 Remote 0915/0939 Receiver Integrated	Motor 9091 Wall Switch 0913/0914 Receiver Integrated	9960, 9961	Motor 9091EL Remote 10300/10302/10303 Receiver Integrated	Motor 9091EL Wall Switch 9943/9946/9948 Light Sensor 10297 Receiver Integrated	n/a	2650
9090/9091/9091EL	Motor 9090 0613 5 Position	Motor 9091 Remote 0915/0939 Receiver Integrated	Motor 9091 Wall Switch 0913/0914 Receiver Integrated	9960, 9961	Motor 9091EL Remote 10300/10302/10303 Receiver Integrated	Motor 9091EL Wall Switch 9943/9946/9948 Light Sensor 10297 Receiver Integrated	n/a	2950
10522/10523	Motor 10522 0615/6/7/8/9 Latching	Motor 10522 Remote 0915/0939 Receiver 0919	Motor 10522 Wall Switch 0913/0914 Receiver 0919	9960, 9961	Motor 10523 Remote 10300/10302/10303 Receiver Integrated	Motor 10523 Wall Switch 9943/9946/9948 Light Sensor 10297 Receiver Integrated	9952 0570	4760
10522/10523	Motor 10522 0615/6/7/8/9 Latching	Motor 10522 Remote 0915/0939 Receiver 0919	Motor 10522 Wall Switch 0913/0914 Receiver 0919	9960, 9961	Motor 10523 Remote 10300/10302/10303 Receiver Integrated	Motor 10523 Wall Switch 9943/9946/9948 Light Sensor 10297 Receiver Integrated	9952 0570	4770
10522/10523	Motor 10522 0615/6/7/8/9 Latching	Motor 10522 Remote 0915/0939 Receiver 0919	Motor 10522 Wall Switch 0913/0914 Receiver 0919	9960, 9961	Motor 10523 Remote 10300/10302/10303 Receiver Integrated	Motor 10523 Wall Switch 9943/9946/9948 Light Sensor 10297 Receiver Integrated	9952 0570	4780
10322/10323	Motor 10322 0615/6/7/8/9 Latching	Motor 10322 Remote 0915/0939 Receiver 0919	Motor 10322 Wall Switch 0913/0914 Receiver 0919	9960, 9961	Motor 10323 Remote 10300/10302/10303 Receiver Integrated	Motor 10323 Wall Switch 9943/9946/9948 Light Sensor 10297 Receiver Integrated	9952 0570	4595
4960 LV	0631	n/a	n/a	n/a	n/a	n/a	n/a	4960 LV
10320/10321	Motor 10320 0615/6/7/8/9 Latching	Motor 10320 Remote 0915/0939 Receiver 0919	Motor 10320 Wall Switch 0913/0914 Receiver 0919	9960, 9961	Motor 10321 Remote 10300/10302/10303 Receiver Integrated	Motor 10321 Wall Switch 9943/9946/9948 Light Sensor 10297 Receiver Integrated	9952 0570	4960
10523/10522	Motor 10522 0615/6/7/8/9 Latching	Motor 10522 Remote 0915/0939 Receiver 0919	Motor 10522 Wall Switch 0913/0914 Receiver 0919	9960, 9961	Motor 10523 Remote 10300/10302/10303 Receiver Integrated	Motor 10523 Wall Switch 9943/9946/9948 Light Sensor 10297 Receiver Integrated	9952 0570	4870
10326/10327	Motor 10326 0615/6/7/8/9 Latching	Motor 10326 Remote 0915/0939 Receiver 0919	Motor 10326 Wall Switch 0913/0914 Receiver 0919	9960, 9961	Motor 10327 Remote 10300/10302/10303 Receiver Integrated	Motor 10327 Wall Switch 9943/9946/9948 Light Sensor 10297 Receiver Integrated	9952 0570	4880
5190	n/a	n/a	n/a	n/a	n/a	n/a	10949	5100B
5190	n/a	n/a	n/a	n/a	n/a	n/a	10949 11092	5100R
5190	n/a	n/a	n/a	n/a	n/a	n/a	10949 11092	5100T

## Application Chart for Silent Gliss® Switches, Remote Control and Multiple Operation of Motorised Systems

Motor Number	Fixed Switch (Hard wired)	Radio Control System 0450		Radio Control System 9940			Timer and Controls	System
		Hand Held Remotes	Wall Switches	Move Server Set	Hand Held Remotes	Wall Switches & Light Sensors		
5190	n/a	n/a	n/a	n/a	n/a	n/a	10949 11092 10946	<b>5100TC</b>
5360	0565/6/7/8/9 Non latching	Remote 0915/0939 Receiver 0918	Wall Switch 0913/0914 Receiver 0918	9960, 9961	Remote 10300/10302/10303 Receiver 9068	Wall Switch 9943/9946/9948 Light Sensor 10297 Receiver 9068	9952	<b>5300</b>
9060	Motor 9060 0615/6/7/8/9	Motor 9060 Remote 0915/0939 Receiver Integrated	Motor 9060 Wall Switch 0913/0914 Receiver Integrated	9960, 9961	Motor 9060 Remote 10300/10302/10303 Receiver Integrated	Motor 9060 Wall Switch 9943/9946/9948 Light Sensor 10297 Receiver Integrated	9952	<b>5600</b>
5805	0615/6/7/8/9 Latching	Remote 0915/0939 Receiver 0919	Wall Switch 0913/0914 Receiver 0919	9960, 9961	Remote 10300/10302/10303 Receiver 9068/9944/9945	Wall Switch 9943/9946/9948 Light Sensor 10297 Receiver 9068/9944/9945	n/a	<b>5800</b>
8060	0928/0937 5 Position	Remote 0915/0939 Receiver 0907 (Pulse enabled)	Wall Switch 0913/0914 Receiver 0907 (Pulse Enabled)	9960, 9961	Remote 10300/10302/10303 Receiver 9068/9947	Wall Switch 9943/9946/9948 Light Sensor 10297 Receiver 9068/9947	n/a	<b>8250</b>
8060				9960, 9961	Remote 10300/10302/10303 Receiver 9068/9947	Wall Switch 9943/9946/9948 Light Sensor 10297 Receiver 9068/9947	n/a	<b>8500</b>
8605	0615/6/7/8/9 Latching	Remote 0915/0939 Receiver 0919	Wall Switch 0913/0914 Receiver 0919	9960, 9961	Remote 10300/10302/10303 Receiver 9068/9944/9945	Wall Switch 9943/9946/9948 Light Sensor 10297 Receiver 9068/9944/9945	9952 0570	<b>8600</b>
9009	0613 5 Position	Remote 0915/0939 Receiver 0919 (Pulse enabled)	Wall Switch 0913/0914 Receiver 0919 (Pulse enabled)	9960, 9961	Remote 10300/10302/10303 Receiver 9068/9944/9945	Wall Switch 9943/9946/9948 Light Sensor 10297 Receiver 9068/9944	0570	<b>8800</b>
11095 11096	0613 5 Position	Remote 0915/0939 Receiver 0919 (Pulse enabled)	Wall Switch 0913/0914 Receiver 0919 (Pulse enabled)	9960, 9961	Remote 10300/10302/10303 Receiver integrated	Wall Switch 9943/9946/9948 Light Sensor 10297 Receiver integrated	0570	<b>8960</b>



For motor types and connections see wiring diagrams.

# Terms & Conditions of Trading with Silent Gliss Ltd

The buyer's attention is in particular drawn to the provisions of condition 12.4.

## 1. INTERPRETATION

- 1.1 The definitions and rules of interpretation in this condition apply in these conditions.
- Buyer:** the person, firm or company who purchases the Goods and/or Services from the Company.
- Company:** Silent Gliss Ltd.
- Contract:** any contract between the Company and the Buyer for the sale and purchase of the Goods and/or provision of Services, incorporating these conditions.
- Delivery Point:** the place where delivery of the Goods is to take place under condition 4.
- Goods:** any goods agreed in the Contract to be supplied to the Buyer by the Company (including any part or parts of them).
- Services:** any installation services agreed in the Contract to be supplied to the Buyer by the Company.
- 1.2 A reference to a particular law is a reference to it as it is in force for the time being taking account of any amendment, extension, application or re-enactment and includes any subordinate legislation for the time being in force made under it.
- 1.3 Words in the singular include the plural and in the plural include the singular.
- 1.4 A reference to one gender includes a reference to the other gender.
- 1.5 Condition headings do not affect the interpretation of these conditions.

## 2. APPLICATION OF TERMS

- 2.1 Subject to any variation under condition 2.3 the Contract shall be on these conditions to the exclusion of all other terms and conditions (including any terms or conditions which the Buyer purports to apply under any purchase order, confirmation of order, specification or other document).
- 2.2 No terms or conditions endorsed on, delivered with or contained in the Buyer's purchase order, confirmation of order, specification or other document shall form part of the Contract simply as a result of such document being referred to in the Contract.
- 2.3 These conditions apply to all the Company's sales and any variation to these conditions and any representations about the Goods and/or Services shall have no effect unless expressly agreed in writing and signed by the Sales Director of the Company. The Buyer acknowledges that it has not relied on any statement, promise or representation made or given by or on behalf of the Company which is not set out in the Contract. Nothing in this condition shall exclude or limit the Company's liability for fraudulent misrepresentation.
- 2.4 Each order or acceptance of a quotation for Goods and/or Services from the Company shall be deemed to be an offer by the Buyer to buy Goods and/or Services subject to these conditions.
- 2.5 No order placed by the Buyer shall be deemed to be accepted by the Company until a written acknowledgement of order is issued by the Company or (if earlier) the Company delivers the Goods to and/or carries out the Services for the Buyer.
- 2.6 The Buyer shall ensure that the terms of its order and any applicable specification are complete and accurate.
- 2.7 Any quotation is given on the basis that no Contract shall come into existence until the Company despatches an acknowledgement of order to the Buyer. Any quotation is valid for a period of 60 days only from its date, provided that the Company has not previously withdrawn it.

## 3. DESCRIPTION

- 3.1 The quantity and description of the Goods and/or Services shall be as set out in the Company's quotation or acknowledgement of order.
- 3.2 All samples, drawings, descriptive matter, specifications and advertising issued by the Company and any descriptions or illustrations contained in the Company's catalogues or brochures are issued or published for the sole purpose of giving an approximate idea of the Goods described in them. They shall not form part of the Contract and this is not a sale by sample.

## 4. DELIVERY

- 4.1 Unless otherwise agreed in writing by the Company, delivery of the Goods shall take place at the time the Goods have been unloaded at the delivery address nominated by the Buyer.

- 4.2 The Buyer shall take delivery of the Goods within 30 days of the Company giving it notice that the Goods are ready for delivery.
- 4.3 Any dates specified by the Company for delivery of the Goods or commencement or duration for performance of the Services are intended to be an estimate and time for delivery and/or performance shall not be made of the essence by notice. If no dates are so specified, delivery and/or performance shall be within a reasonable time.
- 4.4 Subject to the other provisions of these conditions the Company shall not be liable for any direct, indirect or consequential loss (all three of which terms include, without limitation, pure economic loss, loss of profits, loss of business, depletion of goodwill and similar loss), costs, damages, charges or expenses caused directly or indirectly by any delay in the delivery of the Goods or performance of the Services (even if caused by the Company's negligence), nor shall any delay entitle the Buyer to terminate or rescind the Contract unless such delay exceeds 60 days.
- 4.5 If for any reason the Buyer fails to accept delivery of any of the Goods when they are ready for delivery, or the Company is unable to deliver the Goods on time because the Buyer has not provided appropriate instructions, documents, licences or authorisations:
- (a) risk in the Goods shall pass to the Buyer (including for loss or damage caused by the Company's negligence);
  - (b) the Goods shall be deemed to have been delivered; and
  - (c) the Company may store the Goods until delivery, whereupon the Buyer shall be liable for all related costs and expenses (including, without limitation, storage and insurance).

- 4.6 If the Company delivers to the Buyer a quantity of Goods of up to 5% more or less than the quantity accepted by the Company, the Buyer shall not be entitled to object to or reject the Goods or any of them by reason of the surplus or shortfall and shall pay for such goods at the pro rata Contract rate.
- 4.7 The Company may deliver the Goods by separate instalments. Each separate instalment shall be invoiced and paid for in accordance with the provisions of the Contract.
- 4.8 Each instalment shall be a separate Contract and no cancellation or termination of any one Contract relating to an instalment shall entitle the Buyer to repudiate or cancel any other Contract or instalment.

## 5. CANCELLATIONS AND RETURNS

The Buyer shall not be entitled to cancel any Contract or return Goods for refund without the prior written consent of the Company (which will be the absolute discretion of the Company) and payment of a handling charge of 20% of the Price in respect of ex stock items and in the case of made-to-measure items a percentage of the Price dependent upon the stage of manufacture reached at the point of cancellation.

## 6. NON-DELIVERY

- 6.1 The quantity of any consignment of Goods as recorded by the Company upon despatch from the Company's place of business shall be conclusive evidence of the quantity received by the Buyer on delivery unless the Buyer can provide conclusive evidence proving the contrary.
- 6.2 The Company shall not be liable for any non-delivery of Goods (even if caused by the Company's negligence) unless the Buyer gives written notice to the Company of the non-delivery within 7 days of the date when the Goods would in the ordinary course of events have been received.
- 6.3 Any liability of the Company for non-delivery of the Goods shall be limited to replacing the Goods within a reasonable time or issuing a credit note at the pro rata Contract rate against any invoice raised for such Goods.

## 7. INSTALLATION

- 7.1 All costs in relation to Installation by the Company shall be payable by the Buyer in addition to the price of the Goods. The following standard charges apply (duration of each installation is dependent on the type of work being carried out):
- £350 + VAT per day (per engineer)
  - £250 + VAT per ½ day (per engineer)
  - £220 + VAT Service Callout (parts not included)
- 7.2 The Buyer shall be solely responsible for ensuring that its site and adequate and safe access thereto is ready for installation of the Goods. Fixing points must be adequate for the proper and secure installation of the Goods. The Buyer must pay for the cost of any modification to its site or the Goods that is required to enable the Goods to be properly installed.

- 7.3 The Buyer shall be solely responsible for all ancillary work required and costs incurred in connection with installation of Goods, including (without limitation) access, scaffolding hire, electrical work, decorating, or making good.
- 7.4 The Buyer shall advise the Company of any hidden obstruction (including without limitation, electricity, telephone and other communications cables and water, gas and drainage pipes) that may be encountered during installation of the Goods. The Company will not be liable for any damage to any structure, surface or service. The Buyer will pay all costs incurred by the Company in consequence of any damage to any hidden obstruction and will indemnify the Company against all liability, loss, cost and expense that it incurs arising out of or in consequence of installation of the Goods or damage to any structure, surface or service.
- 7.5 At all times, suppliers must comply with the Regulations. The Regulations provide that the Suppliers performing the installation services must fit any safety device supplied with the Goods.
- (a) In the event that the Customer should refuse to allow the Supplier to fit any such safety device accompanying the Goods, then the Supplier will be at liberty to refuse to carry out the Services. In such instance, the Customer will still be liable to pay the Supplier the Price in full under the Contract.
- (b) The Customer shall not be entitled to treat the Suppliers refusal to carry out any Services in relation to the Goods for the reasons set out in this clause 7.4 as a fundamental or any breach of contract. The Customer will still be bound under the Contract to take delivery of the Goods.
- 7.6 The parties to the contract consider the provisions of this clause 7.4 to be reasonable under all the circumstances given the Supplier's obligations under the Regulations.
- 8. RISK/TITLE**
- 8.1 The Goods are at the risk of the Buyer from the time of delivery.
- 8.2 Ownership of the Goods shall not pass to the Buyer until the Company has received in full (in cash or cleared funds) all sums due to it in respect of:
- (a) the Goods; and
- (b) all other sums which are or which become due to the Company from the Buyer on any account.
- 8.3 Until ownership of the Goods has passed to the Buyer, the Buyer shall:
- (a) hold the Goods on a fiduciary basis as the Company's bailee;
- (b) store the Goods (at no cost to the Company) separately from all other goods of the Buyer or any third party in such a way that they remain readily identifiable as the Company's property;
- (c) not destroy, deface or obscure any identifying mark or packaging on or relating to the Goods; and
- (d) maintain the Goods in satisfactory condition and keep them insured on the Company's behalf for their full price against all risks to the reasonable satisfaction of the Company. On request the Buyer shall produce the policy of insurance to the Company.
- 8.4 The Buyer may resell the Goods before ownership has passed to it solely on the following conditions:
- (a) any sale shall be effected in the ordinary course of the Buyer's business at full market value; and
- (b) any such sale shall be a sale of the Company's property on the Buyer's own behalf and the Buyer shall deal as principal when making such a sale.
- 8.5 The Buyer's right to possession of the Goods shall terminate immediately if:
- (a) the Buyer has a bankruptcy order made against him or makes an arrangement or composition with his creditors, or otherwise takes the benefit of any statutory provision for the time being in force for the relief of insolvent debtors, or (being a body corporate) convenes a meeting of creditors (whether formal or informal), or enters into liquidation (whether voluntary or compulsory) except a solvent voluntary liquidation for the purpose only of reconstruction or amalgamation, or has a receiver and/or manager, administrator or administrative receiver appointed of its undertaking or any part thereof, or documents are filed with the court for the appointment of an administrator of the Buyer or notice of intention to appoint an administrator is given by the Buyer or its directors or by a qualifying floating charge holder (as defined in paragraph 14 of Schedule B1 to the Insolvency Act 1986), or a resolution is passed or a petition presented to any court for the winding-up of the Buyer or for the granting of an administration order in respect of the Buyer, or any proceedings are commenced relating to the insolvency or possible insolvency of the Buyer; or
- (b) the Buyer suffers or allows any execution, whether legal or equitable, to be levied on his/its property or obtained against him/it, or fails to observe or perform any of his/its obligations under the Contract or any other contract between the Company and the Buyer, or is unable to pay its debts within the meaning of section 123 of the Insolvency Act 1986 or the Buyer ceases to trade; or
- (c) the Buyer encumbers or in any way charges any of the Goods.
- 8.6 The Company shall be entitled to recover payment for the Goods notwithstanding that ownership of any of the Goods has not passed from the Company.
- 8.7 The Buyer grants the Company, its agents and employees an irrevocable licence at any time to enter any premises where the Goods are or may be stored in order to inspect them, or, where the Buyer's right to possession has terminated, to recover them.
- 8.8 Where the Company is unable to determine whether any Goods are the goods in respect of which the Buyer's right to possession has terminated, the Buyer shall be deemed to have sold all goods of the kind sold by the Company to the Buyer in the order in which they were invoiced to the Buyer.
- 8.9 On termination of the Contract, howsoever caused, the Company's (but not the Buyer's) rights contained in this condition 8 shall remain in effect.
- 9. PRICE**
- 9.1 Unless otherwise agreed by the Company in writing, the price for the Goods and/or Services shall be the price set out in the Company's price list published on the date of delivery or deemed delivery.
- 9.2 The price for the Goods and/or Services shall be exclusive of any value added tax.
- 9.3 All costs or charges in relation to carriage and insurance during transit shall be payable by the Buyer in addition to the price of the Goods when it is due to pay for the Goods where the price of the Goods in any Contract is less than £150 before value-added tax, and in all other cases such costs or charges shall be borne by the Company.
- 9.4 For shipments outside UK mainland, i.e. Highlands, Channel Islands, the Company reserves the right to charge a delivery supplement.
- 10. PAYMENT**
- 10.1 Subject to condition 10.4, payment of the price for the Goods is due in pounds sterling on the last working day of the month following the month in which the Goods are delivered or deemed to be delivered and/or the services are performed.
- 10.2 Time for payment shall be of the essence.
- 10.3 No payment shall be deemed to have been received until the Company has received cleared funds.
- 10.4 All payments payable to the Company under the Contract shall become due immediately on its termination despite any other provision.
- 10.5 The Buyer shall make all payments due under the Contract in full without any deduction whether by way of set-off, counterclaim, discount, abatement or otherwise unless the Buyer has a valid court order requiring an amount equal to such deduction to be paid by the Company to the Buyer.
- 10.6 If the Buyer fails to pay the Company any sum due pursuant to the Contract, the Buyer shall be liable to pay interest to the Company on such sum from the due date for payment at the annual rate of 1.5% per month, accruing on a daily basis until payment is made, whether before or after any judgment.
- 11. QUALITY**
- 11.1 The Company warrants that (subject to the other provisions of these conditions):
- (a) upon delivery, and for a period of five years from the date of delivery the Goods shall
- (i) be of satisfactory quality within the meaning of the Sale of Goods Act 1979;
- (ii) be reasonably fit for purpose; and
- (b) the Services shall be performed with reasonable skill and care.
- (c) This warranty applies to hardware only. Fabric is subject to suppliers' guarantees.
- 11.2 The Company shall not be liable for a breach of any of the warranties in condition 11.1 unless:
- (a) the Buyer gives written notice of the defect to the Company, and, if the defect is as a result of damage in transit to the carrier, within 7 days of the time when the Buyer discovers or ought to have discovered the defect;
- (b) where the contract is for supply only of Goods the Company is given a reasonable opportunity after receiving the notice of

- examining the Goods and the Buyer (if asked to do so by the Company) returns such Goods to the Company's place of business at the Company's cost for the examination to take place there; and
- (c) where the Contract is for supply and installation of Goods the Company is given a reasonable opportunity after receiving notice of examining the Goods and their installation on site.
- 11.3 The Company shall not be liable for a breach of any of the warranties in condition 11.1 if:
- the Buyer makes any further use of such Goods after giving such notice; or
  - the defect arises because the Buyer failed to follow the Company's oral or written instructions as to the storage, installation, commissioning, use or maintenance of the Goods or (if there are none) good trade practice; or
  - the Buyer alters or repairs such Goods without the written consent of the Company.
- 11.4 Subject to condition 11.2 and condition 11.3, if any of the Goods and/or Services do not conform with any of the warranties in condition 11.1 the Company shall
- if the Contract is for supply only of Goods, at its option repair or replace such Goods (or the defective part) or refund the price of such Goods at the pro rata Contract rate provided that, if the Company so requests, the Buyer shall, at the Company's expense, return the Goods or the part of such Goods which is defective to the Company;
  - if the Contract includes installation of Goods by the Company, the Services shall be re-performed by the Company on site until such Services are in conformity or at the Company's option it may pay for the Services to be performed again.
- 11.5 If the Company complies with condition 11.4 it shall have no further liability for a breach of any of the warranties in condition 11.1 in respect of such Goods and/or Services.
- 11.6 Any Goods replaced shall belong to the Company and any repaired or replacement Goods shall be guaranteed on these terms for the unexpired portion of the five year period.
- 11.7 The Buyer is responsible for ensuring the suitability of and absence from manufacturing flaws in any fabric supplied by the Buyer and for marking any such flaws. The Company is not responsible for the performance of any fabric supplied by the Buyer, including (without limitation) its adhesive capabilities when attaching bond cloth, shrinkage, matching of patterns and manufacture into roller blinds. The Buyer is responsible for all fabric and labour costs of remedying fabric flaws discovered by the Company in the course of manufacturing the Goods.
- 12. LIMITATION OF LIABILITY**
- 12.1 Subject to condition 4, condition 6 and condition 11, the following provisions set out the entire financial liability of the Company (including any liability for the acts or omissions of its employees, agents and sub-contractors) to the Buyer in respect of:
- any breach of these conditions;
  - any use made or resale by the Buyer of any of the Goods, or of any product incorporating any of the Goods; and
  - any representation, statement or tortious act or omission including negligence arising under or in connection with the Contract.
- 12.2 All warranties, conditions and other terms implied by statute or common law (save for the conditions implied by section 12 of the Sale of Goods Act 1979) are, to the fullest extent permitted by law, excluded from the Contract.
- 12.3 Nothing in these conditions excludes or limits the liability of the Company:
- for death or personal injury caused by the Company's negligence; or
  - under section 2(3), Consumer Protection Act 1987; or
  - for any matter which it would be illegal for the Company to exclude or attempt to exclude its liability; or
  - for fraud or fraudulent misrepresentation.
- 12.4 Subject to condition 12.2 and condition 12.3:
- the Company's total liability in contract, tort (including negligence or breach of statutory duty), misrepresentation, restitution or otherwise, arising in connection with the performance or contemplated performance of the Contract shall be limited to the Contract price; and
  - the Company shall not be liable to the Buyer for any pure economic loss, loss of profit, loss of business, depletion of goodwill or otherwise, in each case whether direct, indirect or consequential, or any claims for consequential compensation whatsoever (howsoever caused) which arise out of or in connection with the Contract.
- 13. ASSIGNMENT**
- 13.1 The Company may assign the Contract or any part of it to any person, firm or company.
- 13.2 The Buyer shall not be entitled to assign the Contract or any part of it without the prior written consent of the Company.
- 14. FORCE MAJEURE**
- The Company reserves the right to defer the date of delivery or to cancel the Contract or reduce the volume of the Goods ordered by the Buyer (without liability to the Buyer) if it is prevented from or delayed in the carrying on of its business due to circumstances beyond the reasonable control of the Company including, without limitation, acts of God, governmental actions, war or national emergency, acts of terrorism, protests, riot, civil commotion, fire, explosion, flood, epidemic, lock-outs, strikes or other labour disputes (whether or not relating to either party's workforce), or restraints or delays affecting carriers or inability or delay in obtaining supplies of adequate or suitable materials, provided that, if the event in question continues for a continuous period in excess of 60 days, the Buyer shall be entitled to give notice in writing to the Company to terminate the Contract.
- 15. GENERAL**
- 15.1 Each right or remedy of the Company under the Contract is without prejudice to any other right or remedy of the Company whether under the Contract or not.
- 15.2 If any provision of the Contract is found by any court, tribunal or administrative body of competent jurisdiction to be wholly or partly illegal, invalid, void, voidable, unenforceable or unreasonable it shall to the extent of such illegality, invalidity, voidness, voidability, unenforceability or unreasonableness be deemed severable and the remaining provisions of the Contract and the remainder of such provision shall continue in full force and effect.
- 15.3 Failure or delay by the Company in enforcing or partially enforcing any provision of the Contract shall not be construed as a waiver of any of its rights under the Contract.
- 15.4 Any waiver by the Company of any breach of, or any default under, any provision of the Contract by the Buyer shall not be deemed a waiver of any subsequent breach or default and shall in no way affect the other terms of the Contract.
- 15.5 The parties to the Contract do not intend that any term of the Contract shall be enforceable by virtue of the Contracts (Rights of Third Parties) Act 1999 by any person that is not a party to it.
- 15.6 The formation, existence, construction, performance, validity and all aspects of the Contract shall be governed by English law and the parties submit to the exclusive jurisdiction of the English courts.
- 16. COMMUNICATIONS**
- 16.1 All communications between the parties about the Contract shall be in writing and delivered by hand or sent by pre-paid first class post or sent by fax:
- (in case of communications to the Company) to its registered office or such changed address as shall be notified to the Buyer by the Company; or
  - (in the case of the communications to the Buyer) to the registered office of the addressee (if it is a company) or (in any other case) to any address of the Buyer set out in any document which forms part of the Contract or such other address as shall be notified to the Company by the Buyer.
- 16.2 Communications shall be deemed to have been received:
- if sent by pre-paid first class post, two days (excluding Saturdays, Sundays and bank and public holidays) after posting (exclusive of the day of posting); or
  - if delivered by hand, on the day of delivery; or
  - if sent by fax on a working day prior to 4.00 pm, at the time of transmission and otherwise on the next working day.
- 16.3 Communications addressed to the Company shall be marked for the attention of the Sales Director.









[www.silentgliss.co.uk](http://www.silentgliss.co.uk)

Silent Gliss Ltd  
Head Office and Factory  
Pyramid Business Park  
Poorhole Lane, Broadstairs  
Kent CT10 2PT

Tel: 00 44 (0)1843 863571  
Fax: 00 44 (0)1843 864503  
[sales@silentgliss.co.uk](mailto:sales@silentgliss.co.uk)