

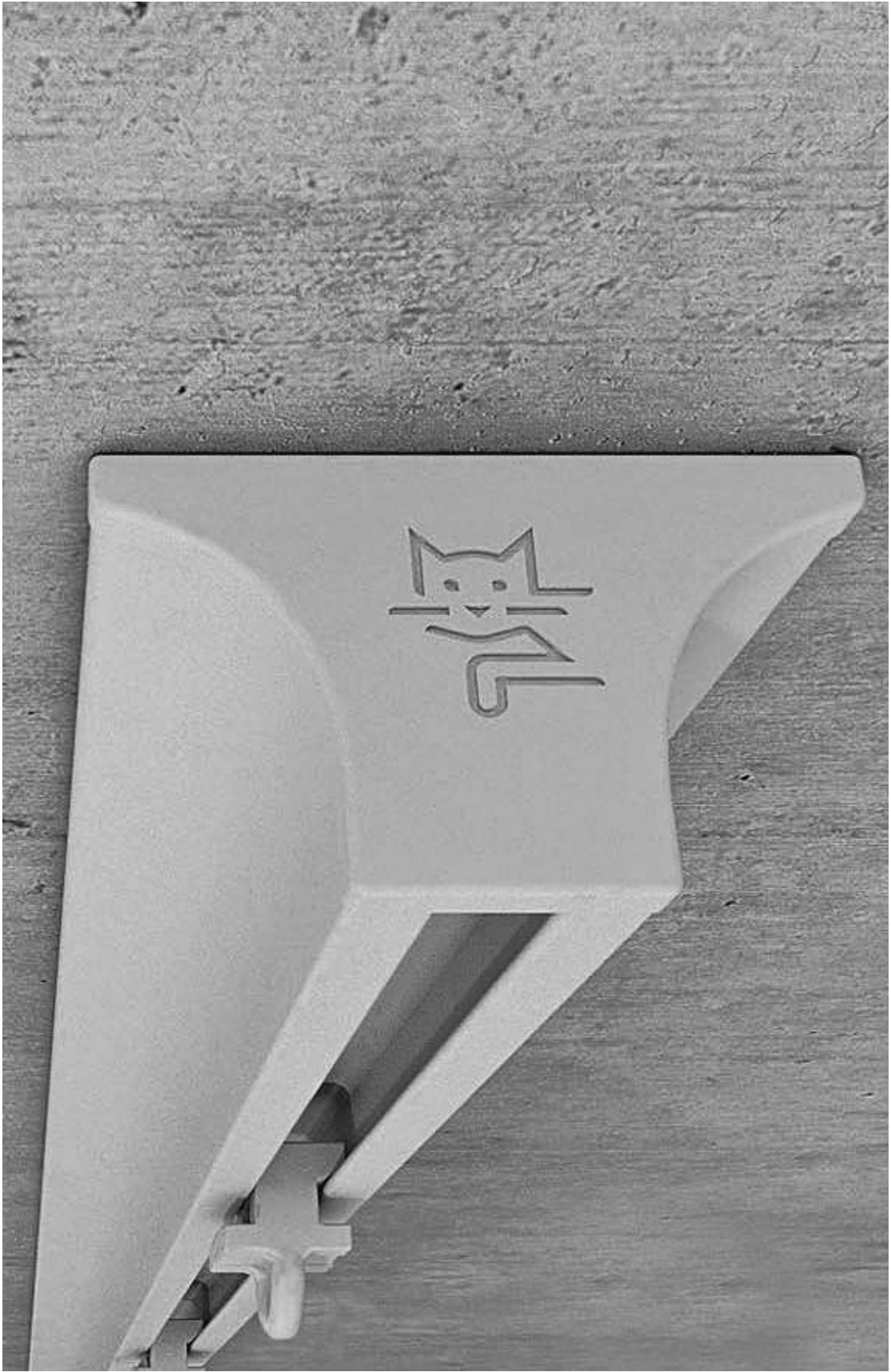

# PRICE LIST



















RECOMMENDED RETAIL PRICES  
EXCLUDING VAT  
APRIL 2019

 **SilentGliss**



This price list is intended to give comprehensive price information on all systems and on all components used with them. Its format follows that of the main Silent Gliss catalogue. Accessories usable with any given system should appear underneath that system.

## Index

	<b>Hand Operated Curtain Tracks, Picture Hanging</b> SG 1020, SG 1021, SG 1025, SG 1070, SG 1080, SG 1090, SG 1280, SG 6010, SG 6290, SG 6021, SG 6243, SG 6293, SG 6380, SG 6465, SG 6820, SG 6840, SG 6870, SG 6970 Pages: 2-9
	<b>Cord Operated Curtain Tracks, Heavy Duty/Stage Curtain Tracks</b> SG 3000, SG 3840, SG 3870, SG 3900, SG 3970, SG 6370 Pages: 10-13
	<b>Pole Systems</b> SG 1003M, SG 6100M, SG 6120M, SG 6130M, SG 6140M, SG 6150M, SG 6160M Pages: 14-22
	<b>Room Divider Systems, Cubicle, Shower, Safety Device System</b> SG 6100, SG 6103, SG 6650 Pages: 23-24
	<b>Electrically Operated Curtain Tracks</b> SG 5100B, SG 5100R, SG 5100T, SG 5100TC, SG 5300, SG 5600, SG 5800 Pages: 25-27
	<b>Switches, Remote Control and Multiple Operation of Motorised Systems</b> SG 0450, SG 9940, Battery Operated Controls, SMART. Page: 28
	<b>Roman, Austrian, Festoon Blind Systems</b> SG 2120, SG 2304, SG 2305, SG 2345, SG 2350, Made-to-measure Roman Blinds Pages: 29-31
	<b>Sliding Panel Systems</b> SG 2700, SG 2730, SG 2740 Page: 32-33
	<b>Skylight Systems</b> SG 2190, SG 2195, SG 8600, SG 8640 Page: 34-36
	<b>Vertical Blinds</b> SG 2810, SG 2900, SG 2950 Pages: 37-43
	<b>Roller Blinds</b> SG 4900, SG 4907, SG 4910, SG 4930, SG 4840, SG 4955, SG 4960, SG 4970, SG 4880, Application chart Pages: 44-56
	<b>Dim-Out Blinds</b> SG 4710, SG 4730, SG 4740, SG 4760, SG 4770, SG 4780 Pages: 57-60
	<b>Venetian Blinds</b> SG 8110 (16mm), SG 8110PC (25mm), SG 8250, SG 8300, SG 8910, SG 8960 Pages: 61-71
	<b>Plissée Pleated Blinds</b> SG 8500 Pages: 72
	<b>Digital Printing/Special Colours (profile/components)</b> Page: 73
	<b>Wave® Standard Curtains</b> Page: 74
	<b>Snake Wave Curtains</b> Page: 75
	<b>Parts Index/Tools &amp; Packaging/Application Chart for switches, remote control and multiple operation of motorised systems/Conditions of Sale</b> Pages: 76-96

## Prices

Prices are maximum recommended Retail Price, not including VAT. Trade discounts applicable vary with product group as detailed below. Each system and item is designated as belonging to one of the following groups:-

**Product Group A** 1003, 1020, 1021, 1025, 1070, 1080, 1090, 1280, 2120, 2304, 2305, 3000, 3600, 3840, 3870, 3900, 5100B, 5100R, 5100T, 5100TC, 6010, 6021, 6100, 6103, 6120, 6130, 6140, 6150\*, 6290, 6243, 6293, 6380, 6465, 6650, 6820, 6840, 6870, 6970 made to measure Roman blinds.

**Product Group C** 0450, 2190, 2195, 2345, 2350, 2700, 2730, 2740, 2810, 2900, 2950, 3970, 4710, 4730, 4740, 4760, 4770, 4780, 4930, 4840, 4970, 4880, 4900, 4907, 4910, 4955, 4960, 5300, 5600, 5800, 6150\*, 6370, 8110, 8250, 8300, 8500, 8600, 8640, 8910, 8960, 9940, SMART.

Silent Gliss Fabrics, Laminated blinds.

**Product Group E** Tools, Promotional material.

\*5100 version + 5600 version.



# Hand Operated Curtain Tracks

## SG 1020

(Available 1st May)

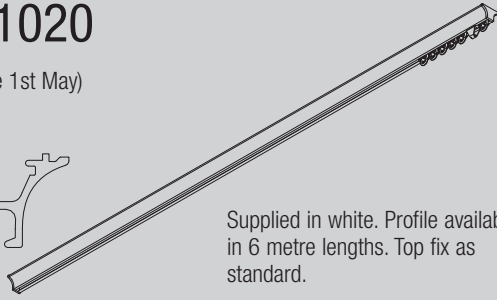
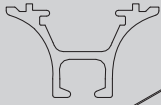

Supplied in white. Profile available in 6 metre lengths. Top fix as standard.

## SG 1021



Supplied in satin silver or white. For special colours see below – special order.

## SG 1025

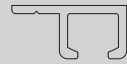

Silver profile available in 5 and 6 metre lengths, white in 6 metre lengths only.

		Price Ctg.
<b>System Prices</b>		<b>A</b>
Specific lengths charged at the nearest 25cm increment above.		
	White	
cm	£	
125	42.32	
150	45.75	
175	52.16	
200	55.59	
225	61.99	
250	65.42	
275	71.83	
300	75.26	
325	81.66	
350	85.09	
375	91.50	
400	94.93	
425	101.34	
450	104.76	
475	111.17	
500	114.60	
525	121.01	
550	124.44	
575	130.84	
600	134.27	
Prices above are for systems ready-assembled. Substantial savings can be made for self-assembly. Rail can be supplied in full lengths or cut-to-size with accessories separately.		

		Price Ctg.
<b>Rail and Standard Accessories</b>		<b>A</b>
6822 Rail, white in 6m.		
6824 Endcover white, each, 10, 100.		
3016 Endstop, each, 100.		
3533 Glider Box, 100.		
Self-service sachets, 25 x 25, Euroslat sachet 25.		
3534 Glider, in strip form, at 16 per m, outer 1000.		
11236 Clip, 100.		

		Price Ctg.
<b>Optional Accessories</b>		<b>A</b>
(additional charges may apply)		
3017 Endstop, each, 100.		
3062 Connecting bridge.		
3070 Twist eye endstop, each, 10.		
3071 Screw twist endstop, each, 10.		
3511 Glider, 100, outer, 25,000.		
3548 Retrofit glider, 25, 100, 1000.		
3570 Rotating glider, 10, 100.		
3582 Hook, Box, 100. Self service sachets, 25x25.Outer,1,000.		
Outer, 20,000.		
3599 Hook, box 100, outer 25,000.		
10430-10434 Draw Rods, white or aluminium.		
<b>Colours</b>		<b>E</b>
Other colours special order - see Page 73.		
<b>Bending</b>		<b>33 1/3%</b>
	Max. trade discount	
Angle bend £29.50 each.		
Semi-circle or gradual curve £38.00 each.		

		Price Ctg.
<b>System Prices</b>		<b>A</b>
Specific lengths charged at the nearest 25cm increment above.		
	Silver	White
cm	£	£
125	15.00	24.45
150	18.04	29.37
175	21.02	34.23
200	24.01	39.08
225	27.03	43.98
250	30.03	48.82
275	33.01	53.72
300	36.05	58.65
325	39.06	63.53
350	42.03	68.40
375	45.00	73.31
400	48.06	78.18
425	51.08	83.05
450	54.04	87.90
475	57.06	92.91
500	60.05	97.74
525	63.07	102.61
550	66.11	107.50
575	69.05	112.41
600	72.07	117.27
Above prices are for systems ready-assembled. Substantial savings can be made for self-assembly. Rail can be supplied in full lengths or cut-to-size with accessories separately.		

		Price Ctg.
<b>Rail and Standard Accessories</b>		<b>A</b>
1021/1025 Rail, silver available in 5m and 6m or cut-to-size.		
White available in 6m or cut-to-size.		
3533 Glider at 16 per metre. Box, 100. Self-service sachets, 25 x 25. Outer, 25,000.		
3534 Glider, in strip form, at 16 per metre.		
Outer, 1,000 gliders,		
6835A Screw, 12mm/1/2" No. 4 round head at 300mm centres, 100.		
3016 Endstop, each, 100.		

		Price Ctg.
<b>Optional Accessories</b>		<b>A</b>
(additional charges may apply)		
3511 Glider, at 16 per metre, 100.		
Outer, 25,000 gliders.		
3532 Glider. 100. Outer, 5,000.		
3570 Rotating glider, 100.		
3582 Hook, Box, 100. Self-service sachets, 25 x 25. Outer, 1,000.		
Outer, 20,000.		
3020 Hook. Metal, 100.		
3599 Hook. Box, 100. Self-service sachets, 25 x 25.		
Outer, 25,000.		
3032 Spring stop, 10, 100.		
3070 Twist eye endstop, each, 10.		
3071 Screw twist endstop, each, 10.		
3562 Standard tape, 100 metres.		
3580 Side mounted glider/hook, 100. Outer, 5,000.		
3571 Hook. Box, 100. Self-service sachets, 25 x 25.		
Outer, 35,000.		
6835B Screw 24mm/1", 100.		
3548 Retrofit glider, 25, 100, 1000.		
3068A Loop tape, 250 metres.		
10430 - 10434 Draw rods, white or aluminium		
<b>Colours</b>		<b>E</b>
Other colours special order - see Page 73.		

		Price Ctg.
<b>Tools</b>		<b>E</b>
80018 Slotting tool		
7809 Filler set at 200cm		
<b>Bending</b>		<b>33 1/3%</b>
	Max. trade discount	
Angle bend £29.50 each		

All prices shown exclude VAT





# Hand Operated Curtain Tracks

## SG 1070

(Available 1st May)

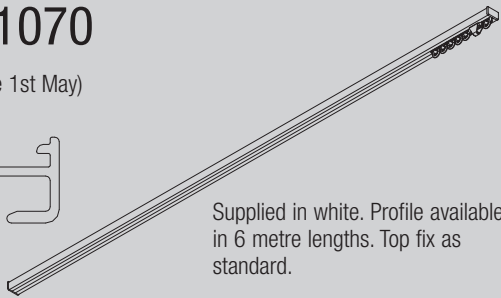
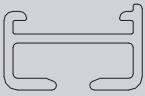

Supplied in white. Profile available in 6 metre lengths. Top fix as standard.

## SG 1080

Supplied in satin silver anodised finish, white, matt white, antique bronze, anodic grey and charcoal. Silver and white profile available in 5 and 6 metre lengths, other coloured profiles 6m only.

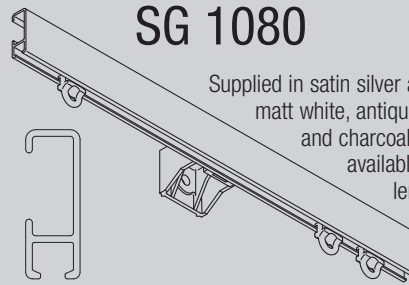
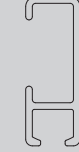

System Prices		Price Ctg.
Specific lengths charged at the nearest 25cm increment above.		<b>A</b>
White		
cm	£	
125	20.53	
150	23.61	
175	27.46	
200	30.54	
225	34.38	
250	37.46	
275	41.31	
300	44.39	
325	48.23	
350	51.31	
375	55.16	
400	58.24	
425	62.08	
450	65.16	
475	69.01	
500	72.09	
525	75.93	
550	79.01	
575	82.86	
600	85.94	
Prices above are for systems ready-assembled. Substantial savings can be made for self-assembly. Rail can be supplied in full lengths or cut-to-size with accessories separately.		

Rail and Standard Accessories		Price Ctg.
1071 Rail, white in 6m Lengths.		<b>A</b>
1072 Endcover white, 10, 100.		
3016 Endstop, each, 100.		
3060 Clamp, each, 10, 100.		
3533 Glider Box, 100.		
Self-service sachets, 25 x 25, Euroslot sachet 25.		
3534 Glider, in strip form, at 16 per m, outer 1000.		

Optional Accessories		Price Ctg.
(additional charges may apply)		<b>A</b>
3017 Endstop.		
3070 Twist eye endstop, each, 10.		
3062 Connecting bridge, each.		
3511 Glider, 100, outer, 25,000.		
3548 Retrofit glider, 25, 100, 1000.		
3570 Rotating glider, 10, 100.		
3582 Hook, box 100, outer 1,000, outer 20,000.		
3599 Hook, box 100, outer 25,000.		
10430-10434 Draw Rods, white or aluminium.		
Colours		<b>E</b>
Other colours special order - see Page 73.		
Bending		
	Max. trade discount	33 1/3%
Angle bend £29.50 each.		
Semi-circle or gradual curve £38.00 each.		

System Prices		Price Ctg.
Specific lengths charged at the nearest 25cm increment above.		<b>A</b>
cm	W/S £	MW/AB/AG/CC £
125*	22.21	37.15
150*	26.63	43.95
175*	31.06	50.82
200*	35.49	57.67
225*	39.92	64.49
250*	44.35	71.36
275*	48.80	78.11
300	53.26	84.94
325	57.66	91.83
350	62.16	98.63
375	66.54	105.49
400	70.95	112.28
425	75.42	119.10
450	79.86	125.97
475	84.26	132.80
500	88.73	139.58
525	93.13	146.44
550	97.58	153.30
575	102.02	160.08
600	106.43	166.97
Above prices are for systems ready-assembled. Substantial savings can be made for self-assembly. Rail can be supplied in full lengths or cut-to-size with accessories separately.		
*1080W Packed in Acetate: For sizes marked with an asterisk above we offer our 1080 in white only in clear acetate self-service display packaging. Prices are the same as indicated above. Min. order 12 lengths.		

Rail and Standard Accessories		Price Ctg.
1080 Rail, silver, white, in 5m & 6m, matt white, antique bronze, anodic grey and charcoal in 6m.		<b>A</b>
3533 Glider Box, 100.		
Self-service sachets, 25 x 25.		
Outer, 25,000. Euroslot sachet 25.		
3534 Glider, in strip form, at 16/m.		
18R Screw 25mm/1". No. 8 round head, 100.		
3667 Endcover/stop, grey, white, matt white, anodic grey, antique bronze, charcoal. each 10, 100. Euroslot sachet 2 (white and grey only).		
3630 Universal nylon bracket, white at 600mm centres, each 10, 100. Euroslot sachet 2.		

Optional Accessories		Price Ctg.
(additional charges may apply)		<b>A</b>
3016 Endstop, each, 100.		
3511 Glider, at 16 per metre, 100. Outer, 25,000 gliders.		
3570 Rotating glider, 100.		
3020 Hook. Metal, 100.		
3638 Reinforced corner piece for pelmets, each, 10.		
3603 Top fix brackets, white, each, 10, 100.		
3548 Retrofit glider, 25, 100, 1000.		
3630 Universal bracket, brown gold, each, 10.		
3571/3582/3599 Hooks - see under 1021/5.		
3070 Twist eye endstop, each, 10.		
1128R Screw 37mm/1 1/2", No. 8 round head, 100.		
3089 Glider hook, 20.		

System Prices		Price Ctg.
Specific lengths charged at the nearest 25cm increment above.		<b>A</b>
cm	W/S £	MW/AB/AG/CC £
125*	22.21	37.15
150*	26.63	43.95
175*	31.06	50.82
200*	35.49	57.67
225*	39.92	64.49
250*	44.35	71.36
275*	48.80	78.11
300	53.26	84.94
325	57.66	91.83
350	62.16	98.63
375	66.54	105.49
400	70.95	112.28
425	75.42	119.10
450	79.86	125.97
475	84.26	132.80
500	88.73	139.58
525	93.13	146.44
550	97.58	153.30
575	102.02	160.08
600	106.43	166.97
Above prices are for systems ready-assembled. Substantial savings can be made for self-assembly. Rail can be supplied in full lengths or cut-to-size with accessories separately.		

System Prices		Price Ctg.
Specific lengths charged at the nearest 25cm increment above.		<b>A</b>
6146 Nylon hook, 12.		
3660 Extra long universal bracket.		
3655 Long universal bracket.		
3662 Standard tape, 100 metres.		
3615 Clamp.		
3620 Connecting bridge, each, 10.		
3602 Nylon wall support, grey, white, each, 10.		
3606 Snap fastener each, 10.		
3618 Metal wall support, each, 10.		
3626 Return fixing bracket, each.		
3639 Hanger rod assembly, 2' system complete.		
3648 Eyelet for 3638.		
Smart Fix Brackets in white or silver		
11118 Smart Fix 60mm Bracket (11200 Set).		
11119 Smart Fix 80mm Bracket (11201 Set).		
11120 Smart Fix 100mm Bracket (11202 Set).		
11121 Smart Fix 120mm Bracket (11203 Set).		
11122 Smart Fix 150mm Bracket (11204 Set).		
11123 Smart Fix 200mm Bracket (11205 Set).		
Square Smart Fix Brackets in white or silver		
11139 Smart Fix 60mm Bracket (11210 Set).		
11140 Smart Fix 80mm Bracket (11211 Set).		
11141 Smart Fix 100mm Bracket (11212 Set).		
11142 Smart Fix 120mm Bracket (11213 Set).		
11143 Smart Fix 150mm Bracket (11214 Set).		
11144 Smart Fix 200mm Bracket (11215 Set).		
Smart Fix Bracket Covers		
11116 Smart Fix Bracket Cover.		
11137 Square Smart Fix Bracket Cover.		
Universal Smart Fix Extension Bracket in white or silver		
11154 Universal Smart Fix 120mm.		
11155 Universal Smart Fix 150mm.		
11156 Universal Smart Fix 200mm.		

System Prices		Price Ctg.
Specific lengths charged at the nearest 25cm increment above.		<b>A</b>
3151 Clearance spacer (for top boards).		<b>E</b>
Colours		<b>E</b>
Other colours special order - see page 73.		
Tools, etc		<b>E</b>
80018 Slotting tool.		
7103 Portable hand operated bending tool.		
7109 Portable electrically operated bending tool.		
7806 Filler set for 1080 at 200cm for 7103/9.		
0540 Bending tool for gradual curves.		
Bending		
	Max. trade discount	33 1/3%
Angle bend £29.50 each.		
Semi-circle or gradual curve £38.00 each.		
Arch £71.00 each.		

System Prices		Price Ctg.
Use prices for 1080 rail only and 3606 supports, covers 3667 where necessary plus special components below.		<b>A</b>
3637 Cord ø 1.5mm nom.		
3600 Picture hanging system complete (including 4x3663, cord 3637 & 3634 delrin height adjuster)		
3657 Connecting bridge for picture hanging system.		
3605 Endcover.		

All prices shown exclude VAT



# Hand Operated Curtain Tracks

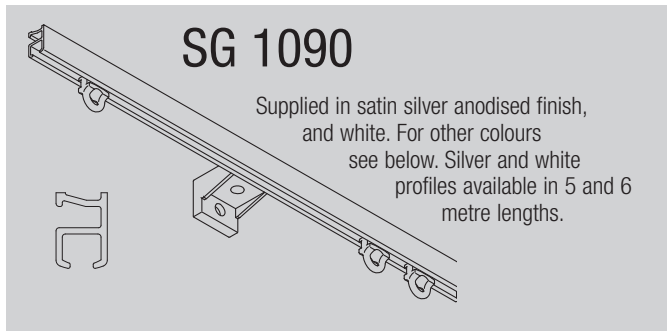

## SG 1090

Supplied in satin silver anodised finish, and white. For other colours see below. Silver and white profiles available in 5 and 6 metre lengths.



## SG 1280

Supplied in white profile available in 5 metre or 6 metre lengths.

System Prices		Price Ctg.
Specific lengths charged at the nearest 25cm increment above.		<b>A</b>
cm	W/S	
125	£ 20.52	
150	24.65	
175	28.74	
200	32.86	
225	36.96	
250	41.02	
275	45.12	
300	49.24	
325	53.40	
350	57.52	
375	61.56	
400	65.68	
425	69.74	
450	73.89	
475	77.95	
500	82.12	
525	86.20	
550	90.28	
575	94.42	
600	98.48	

Rail and Standard Accessories		Price Ctg.
1090 Rail, silver and white in 5m, 6m or cut-to-size. 3533 Glider. Box, 100. Self-service sachets, 25 x 25. Outer, 25,000. Euroslot sachet 25. 3534 Glider, in strip form, at 16 per metre. Outer, 1,000 gliders. 3016 Endstop, each, 100. 3175 Universal Nylon Bracket, white, 10, 100.		<b>A</b>
<b>Optional Accessories</b> (additional charges may apply) 18R Screw, 25mm/1", No. 8 round head, 100. 3511 Glider, at 16 per metre, 100. Outer, 25,000 gliders. 3570 Rotating glider, 100. 3582 Hook, 100. Self-service sachets, 25 x 25. Outer, 1,000. Outer, 20,000. 3020 Hook. Metal, 100. 3599 Hook. Box, 100. Self-service sachets, 25 x 25. Outer, 25,000. 3176 Top fix bracket, white, 10, 100. 3070 Twist eye endstop, each, 10. 1128R Screw 37mm/1½", No. 8 round head, 100. 3548 Retrofit glider, 25, 100, 1000. 3562 Standard tape, 100 metres. 3096 Connecting bridge, each, 10. 3113 5cm metal spacer, 10, 100. 3115 7cm metal spacer, 10, 100. 10430 - 10434 Draw rods, white or aluminium		<b>A</b>
Smart Fix Brackets in white or silver 11118 Smart Fix 60mm Bracket (11200 Set). 11119 Smart Fix 80mm Bracket (11201 Set). 11120 Smart Fix 100mm Bracket (11202 Set). 11121 Smart Fix 120mm Bracket (11203 Set). 11122 Smart Fix 150mm Bracket (11204 Set). 11123 Smart Fix 200mm Bracket (11205 Set).		<b>A</b>
Square Smart Fix Brackets in white or silver 11139 Smart Fix 60mm Bracket (11210 Set). 11140 Smart Fix 80mm Bracket (11211 Set). 11141 Smart Fix 100mm Bracket (11212 Set). 11142 Smart Fix 120mm Bracket (11213 Set). 11143 Smart Fix 150mm Bracket (11214 Set). 11144 Smart Fix 200mm Bracket (11215 Set).		<b>A</b>
Smart Fix Bracket Covers 11116 Smart Fix Bracket Cover. 11137 Square Smart Fix Bracket Cover.		<b>A</b>
Universal Smart Fix Extension Bracket in white or silver 11154 Universal Smart Fix 120mm. 11155 Universal Smart Fix 150mm. 11156 Universal Smart Fix 200mm.		<b>A</b>
<b>Colours</b> Other colours special order – see page 73.		<b>E</b>
<b>Tools</b> Sleeving SL1090, SL1090W per reel. 80018 Slotting tool. 7809 Filler set at 200cm, 2 required		<b>E</b>
<b>Bending</b>	Max. trade discount	33 1/3%
Angle bend £29.50 each. Semi-circle or gradual curve £38.00 each.		

System Prices		Price Ctg.
Specific lengths charged at the nearest 25cm increment above.		<b>A</b>
cm	White	
125	£ 33.77	
150	40.58	
175	47.27	
200	54.03	
225	60.77	
250	67.51	
275	74.30	
300	81.02	
325	87.80	
350	94.52	
375	101.29	
400	108.06	
425	114.75	
450	121.55	
475	128.33	
500	135.03	
525	141.79	
550	148.56	
575	155.32	
600	162.06	

Rail and Standard Accessories		Price Ctg.
1280 White rail, available in 5m or 6m lengths, in outers of 10 lengths only. 3630 Universal nylon bracket, white, at 600mm centres, 100. 3922 Roller glider in strip form at 10 per metre, outer of 1,000 gliders, outer of 6,000 gliders. 3985 Eyelet endcover/endstop in white, 100. 18R Screw 25mm/1", No. 8 round head, 100.		<b>A</b>
<b>Optional Accessories</b> (additional charges may apply) 3620 Connecting bridge. 3975 Overlap for pulling by hand, each, 10. 3935A Combination overlap straight, complete with 'S' hook attachment 3949, each, 10. 3936A Combination overlap complete with 'S' hook attachment 3949, each, 10. 3947 Pair of magnetic gliders, 10. 3942 Intermediate stop, 10. 3603 Top fix bracket, white each, 10, 100. 3582 Hook, box 100, outer 1,000, outer 20,000. 3599 Hook, box 100, outer 25,000. 3562 Standard tape, 100m. 10430 - 10434 Draw rods, white or aluminium		<b>A</b>
Smart Fix Brackets in white or silver 11118 Smart Fix 60mm Bracket (11200 Set). 11119 Smart Fix 80mm Bracket (11201 Set). 11120 Smart Fix 100mm Bracket (11202 Set). 11121 Smart Fix 120mm Bracket (11203 Set). 11122 Smart Fix 150mm Bracket (11204 Set). 11123 Smart Fix 200mm Bracket (11205 Set).		<b>A</b>
Square Smart Fix Brackets in white or silver 11139 Smart Fix 60mm Bracket (11210 Set). 11140 Smart Fix 80mm Bracket (11211 Set). 11141 Smart Fix 100mm Bracket (11212 Set). 11142 Smart Fix 120mm Bracket (11213 Set). 11143 Smart Fix 150mm Bracket (11214 Set). 11144 Smart Fix 200mm Bracket (11215 Set).		<b>A</b>
Smart Fix Bracket Covers 11116 Smart Fix Bracket Cover. 11137 Square Smart Fix Bracket Cover.		<b>A</b>
Universal Smart Fix Extension Bracket in white or silver 11154 Universal Smart Fix 120mm. 11155 Universal Smart Fix 150mm. 11156 Universal Smart Fix 200mm.		<b>A</b>
<b>Colours</b> Other Colours Special Order – Consult Silent Gliss for pricing.		<b>E</b>
<b>Tools</b> 7103 Portable hand operated bending tool. 7109 Portable electrically operated bending tool. 80018 Slotting tool. 7844 Filler set for 7103/7109, 70cm. 7844A Filler set for 0540, 200cm. 0540 Bending tool for gradual curves		<b>E</b>
<b>Bending</b>	Max. trade discount	33 1/3%
Angle bend £29.50 each Semi-circle or gradual curve £38.00 each.		



# Hand Operated Curtain Tracks

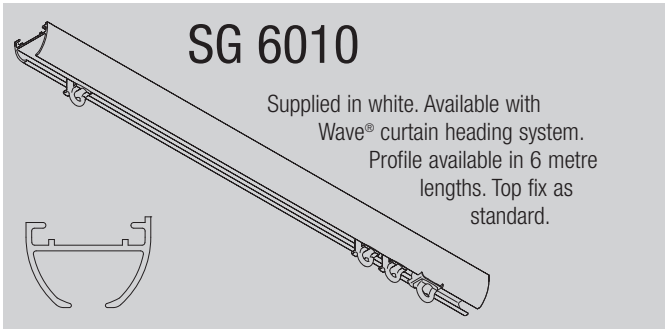

## SG 6010

Supplied in white. Available with Wave® curtain heading system. Profile available in 6 metre lengths. Top fix as standard.

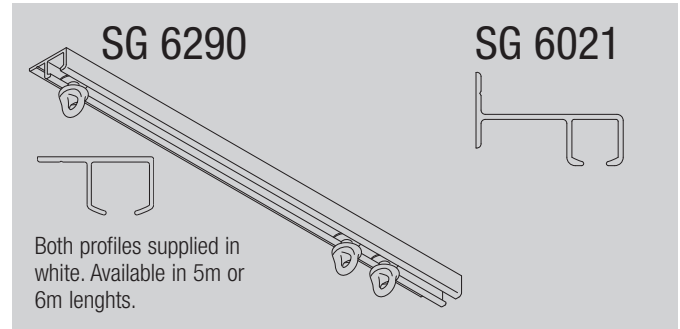

## SG 6290

## SG 6021

Both profiles supplied in white. Available in 5m or 6m lengths.

System Prices				Price Ctg.
Specific lengths charged at the nearest 25cm increment above.				A
cm	Standard Glider	60mm Wave	80mm Wave	
£	£	£	£	
125	43.43	63.00	57.06	
150	49.35	73.01	65.88	
175	57.89	85.35	77.04	
200	63.81	95.36	85.86	
225	72.36	107.71	97.01	
250	78.28	117.72	105.84	
275	86.82	130.06	116.99	
300	92.74	140.07	125.81	
325	101.29	152.41	136.96	
350	107.21	162.42	145.79	
375	115.75	174.76	156.94	
400	121.67	184.78	165.76	
425	130.21	197.12	176.92	
450	136.14	207.13	185.74	
475	144.68	219.47	196.89	
500	150.60	229.48	205.72	
525	159.14	241.82	216.87	
550	165.06	251.84	225.69	
575	173.61	264.18	236.85	
600	179.53	274.19	245.67	

Above prices are for systems ready-assembled. Substantial savings can be made for self-assembly. Rail can be supplied in full lengths or cut-to-size with accessories separately.

Enhanced Wave Options		Price Ctg.
Add the following to the systems prices above:		A
<b>Option 1</b> 2255 Adjustable Brake Single-stack £7.40; Pair-stack £14.79		
<b>Option 2</b> 2255 Adjustable Brake & 6366 Carrier Single-stack £15.01; Pair-stack £30.01		
<b>Option 3</b> Enhanced Wave (80mm only) Single-stack £27.86; Pair-stack £55.72		

Rail and Standard Accessories	
6010 Rail, white, available in 6 metre lengths.	
3825 Clamp.	
6018 Endcover, white.	
6065 Twist eye end stop, 10, 100.	
<b>Standard Gliders</b> 11301 2C Gliders in strip form, at 14 per m, outer 1000.	
<b>Wave Gliders</b> 11302 Wave 2C Glider-cord 80mm. 11303 Wave 2C Glider-cord 60mm.	

All prices shown exclude VAT

Optional Accessories		Price Ctg.
(additional charges may apply)		A
2255 Adjustable brake.		
3020 Hook, Metal, 100.		
3571 Hook, Box, 100. Self-service sachets, 25 x 25. Outer, 35,000.		
3582 Curtain hooks (each).		
3599 Hock. box, 100. Self-service sachets, 25 x 25. Outer, 25,000.		
3802 Connecting bridge.		
3826W Nylon bracket, (top fix).		
3832 Clamp for top fixing.		
6007 Endstop, each 10.		
6053 Spring Stop, 10.		
6064 Endstop.		
6098 Roller-glider with eye.		
6283 Roller-glider.		
6349 Wave® curtain tape.		
6364 Extension.		
6365 Hanger.		
6363 Iron-on hemming tape.		
6366 Draw rod carrier.		
10075 Lead curtain weight.		
10076 Fabric side weight.		
10430-10434 Draw rods, white or aluminium.		
1148C Screw.		

Colours		Price Ctg.
Other colours special order – consult Silent Gliss for pricing.		E

Tools		Price Ctg.
		E
7103 Portable hand operated bending tool.		
7109 Portable electrically operated bending tool.		
7885 Filler set 6010 at 200cm for 7103/7109.		
7439 Blocks for 7103/7109, 2 required.		
7404 Former for 7103/7109, radius 15cm.		

Bending		Price Ctg.
Max. trade discount		
33 1/3%		
Angle bend £46.00 each		
Semi-circle or gradual curve £62.00 each		

System Prices		Price Ctg.
Specific lengths charged at the nearest 25cm increment above.		A
<b>6290 White</b>		
cm	£	
125	20.16	
150	24.21	
175	28.19	
200	32.23	
225	36.28	
250	40.25	
275	44.34	
300	48.33	
325	52.41	
350	56.41	
375	60.47	
400	64.47	
425	68.51	
450	72.53	
475	76.57	
500	80.59	
525	84.62	
550	88.65	
575	92.70	
600	96.72	

System Prices		Price Ctg.
Specific lengths charged at the nearest 25cm increment above.		A
<b>6021 White</b>		
cm	£	
125	25.87	
150	31.05	
175	36.20	
200	41.36	
225	46.55	
250	51.71	
275	56.88	
300	62.02	
325	67.22	
350	72.43	
375	77.59	
400	82.75	
425	87.89	
450	93.08	
475	98.25	
500	103.43	
525	108.59	
550	113.75	
575	118.92	
600	124.13	

Above prices are for systems ready-assembled. Substantial savings can be made for self-assembly. Rail can be supplied in full lengths or cut-to-size with accessories separately.

Rail and Standard Accessories		Price Ctg.
		A
6290 White rail, available in 5/6m lengths.		
6021 White rail available in 5/6m lengths.		
6122 Endstop, 100.		
6148 Glider at 10 per m, 1,000.		
6149 Lead glider (blue) at 2 per length, 100.		
Optional Accessories		A
(additional charges may apply)		
0688 Self drilling wood screw, 100.		
3582 Hook, 100, 1,000, 20,000.		
3599 Hook, 100, 25,000.		
3562 Standard tape, 100m.		
10430 - 10434 Draw rods, white or aluminium		
Colours		E
To special order - see Page 73.		
Bending		
Straight only.		



# Hand Operated Curtain Tracks

## SG 6243

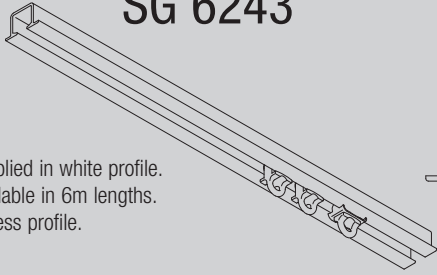

Supplied in white profile.  
Available in 6m lengths.  
Recess profile.

## SG 6293

(Available 1st May)  
Supplied in white. Profile  
available in 6 metre lengths.  
Top fix as standard.

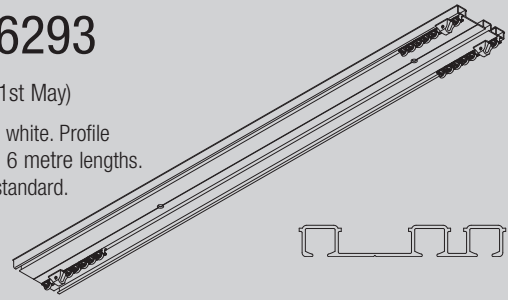

				Price Ctgy.
<b>System Prices</b>				<b>A</b>
Specific lengths charged at the nearest 25cm increment above.				
cm	Standard Glider	Wave Glider		
	£	60mm £	80mm £	
125	36.43	58.36	54.96	
150	41.02	67.35	63.26	
175	45.62	76.31	71.55	
200	50.21	85.30	79.85	
225	54.80	94.27	88.14	
250	59.40	103.25	96.44	
275	63.97	112.24	104.73	
300	68.57	121.20	113.03	
325	73.17	130.19	121.33	
350	77.77	139.17	129.63	
375	82.36	148.14	137.92	
400	86.93	157.12	146.22	
425	91.53	166.10	154.51	
450	96.12	175.07	162.81	
475	100.71	184.06	171.10	
500	105.31	193.03	179.41	
525	109.90	202.01	187.71	
550	114.48	210.98	196.00	
575	119.09	219.97	204.30	
600	123.67	228.94	212.59	
Prices above are for systems ready-assembled. Substantial savings can be made for self-assembly. Rail can be supplied in full lengths or cut-to-size with accessories separately.				

<b>Enhanced Wave Options</b>		Price Ctgy.
Add the following to the systems prices above:		<b>A</b>
<b>Option 1</b> 2255 Adjustable Brake Single-stack £7.40; Pair-stack £14.79		
<b>Option 2</b> 2255 Adjustable Brake & 6366 Carrier Single-stack £15.01; Pair-stack £30.01		
<b>Option 3</b> Enhanced Wave (80mm only) Single-stack £27.86; Pair-stack £55.72		

<b>Rail and Standard Accessories</b>		Price Ctgy.
6053 Spring Stop, 10.		<b>A</b>
6243 White rail available in 6m lengths only.		
6065 Twist eye end stop, 10, 100. 0240 Screw, 19mm, 100.		
Plus one of the following options:		
<b>Standard Gliders</b> 11301 2C Gliders in strip form, at 14 per m, outer 1000.		
<b>Wave Gliders</b> 11302 Wave 2C Glider-cord 80mm. 11303 Wave 2C Glider-cord 60mm.		

<b>Optional Accessories</b>		Price Ctgy.
(additional charges may apply)		<b>A</b>
2255 Adjustable brake.		
3020 Hook, Metal, 100.		
3067 Connecting bridge.		
3571 Hook. Box, 100. Self-service sachets, 25 x 25. Outer, 35,000.		
3582 Curtain hooks (each).		
3599 Hook. box, 100. Self-service sachets, 25 x 25. Outer, 25,000.		
6007 Endstop, each 10.		
6094 Roller glider with hook, 10, 100.		
6099 Roller glider-cord 80mm pitch. Outer of 50mm.		
6283 Roller glider at 10 per metre. Outer 10, 100.		
6349 Wave® curtain tape.		
6364 Extension.		
6365 Hanger.		
6363 Iron-on hemming tape.		
6366 Draw rod carrier.		
7002 Rail protector.		
10075 Lead curtain weight.		
10076 Fabric side weight.		
10430-10434 Draw rods, white or aluminium.		

<b>Colours</b>	Price Ctgy.
To special order – see page 73.	<b>E</b>

<b>Tools</b>	Price Ctgy.
7230 Slotting tool.	<b>E</b>

<b>Bending</b>	Max. trade discount	Price Ctgy.
Angle bend £29.50 each. Gradual curve £38.00 each.	33 <sup>1</sup> / <sub>3</sub> %	

<b>System Prices</b>			Price Ctgy.
Specific lengths charged at the nearest 25cm increment above.			<b>A</b>
cm	Standard Glider	*Std/Roller Glider	
	£	£	
125	58.74	77.75	
150	69.58	91.11	
175	80.41	106.60	
200	91.25	119.95	
225	102.08	135.45	
250	112.92	148.80	
275	123.75	164.29	
300	134.59	177.65	
325	145.42	193.14	
350	156.26	206.49	
375	167.09	221.99	
400	177.93	235.34	
425	188.76	250.84	
450	199.60	264.19	
475	210.44	279.68	
500	221.27	293.04	
525	232.11	308.53	
550	242.94	321.88	
575	253.78	337.38	
600	264.61	350.73	

Prices above are for systems ready-assembled. Substantial savings can be made for self-assembly. Rail can be supplied in full lengths or cut-to-size with accessories separately.

<b>Rail and Standard Accessories</b>	Price Ctgy.
6065 Twist eye endstop, each, 10, 100.	<b>A</b>
6283 Roller glider at 10 per metre. Outer 10, 100.	
6293 Rail, white in 6m lengths. 11301 2C Glider in strip form, at 14 per m, outer 1000.	

\*Standard 11301 gliders for voile and 6283 gliders for main curtains.

<b>Optional Accessories</b>		Price Ctgy.
(additional charges may apply)		<b>A</b>
6083 Glider in strip form, outer 1,000 gliders.		
3599 Hook. Box, 100. Self-service.		
6053 Spring stop, 10.		
6094 Roller glider with hook, 10, 100.		
6098 Roller glider with eye.		
6269 Connecting bridge.		
10430-10434 Draw Rods, white or aluminium.		

<b>Colours</b>	Price Ctgy.
Other colours special order - see Page 73.	<b>E</b>

<b>Bending</b>	Price Ctgy.
Straight only.	





# Hand Operated Curtain Tracks

## SG 6380

(Available 1st May)

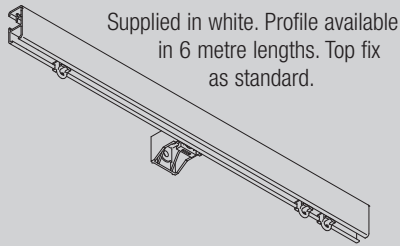

Supplied in white. Profile available in 6 metre lengths. Top fix as standard.



## SG 6465

Supplied in white. Available with Wave® curtain heading system. Profile available in 6 metre lengths. Top fix as standard. Optional recess profile available.

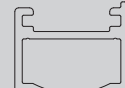
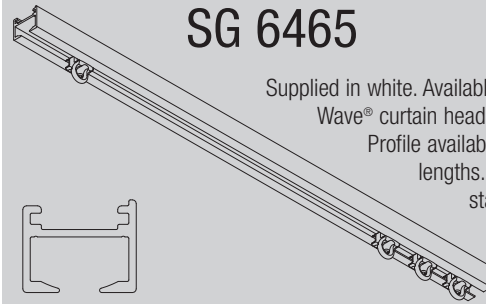

System Prices			Price Ctg.
Specific lengths charged at the nearest 25cm increment above.			A
cm	Standard Glider £	Roller Glider £	
125	46.42	65.14	
150	52.58	74.11	
175	60.50	86.39	
200	66.66	95.36	
225	74.57	107.64	
250	80.74	116.62	
275	88.65	128.90	
300	94.81	137.87	
325	102.73	150.15	
350	108.89	159.12	
375	116.80	171.40	
400	122.96	180.38	
425	130.88	192.66	
450	137.04	201.63	
475	144.96	213.91	
500	151.12	222.88	
525	159.03	235.16	
550	165.19	244.14	
575	173.11	256.41	
600	179.27	265.39	

Prices above are for systems ready-assembled. Substantial savings can be made for self-assembly. Rail can be supplied in full lengths or cut-to-size with accessories separately.

Rail and Standard Accessories		Price Ctg.
3630 Universal nylon bracket, white, 100.		A
6065 Twist eye end stop.		
6283 Roller glider, 10, 100.		
6380 Profile, white in 6m.		
6381 Endcover, white.		
11301 2C Glider in strip form at 14 per m, outer 1000.		

Optional Accessories		Price Ctg.
(additional charges may apply)		A
2255 Adjustable Brake.		
3571 Hook.		
3582 Hook, Box, 100. Self service sachets, 25x25.Outer,1,000.		
3599 Hook, box 100, outer 25,000.		
3603 Top fix bracket, white each, 10, 100.		
3620 Connecting Bridge.		
3655 Long universal bracket.		
3660 Extra long universal bracket		
6007 Endstop white or silver.		
6053 Spring stop, 10.		
6064 Screw twist endstop each, 10.		
6086 Spring stop each, 10, 100.		
6146 Nylon hook, 100.		
6094 Roller glider with hook, 10, 100.		
6098 Roller glider with eye, 10,100.		
6349 Wave® curtain tape.		
6363 Iron-on hemming tape.		
6364 Extension.		
6365 Hanger.		
6366 Draw rod carrier.		
10075 Lead curtain weight.		
10076 Fabric side weight.		
10430-10434 Draw Rods, white or aluminium		
11302 Wave 2C Glider-cord 80mm		
11303 Wave 2C Glider-cord 60mm		
Smart Fix Brackets in white or silver		
11118 Smart Fix 60mm Bracket (11200 Set).		
11119 Smart Fix 80mm Bracket (11201 Set).		
11120 Smart Fix 100mm Bracket (11202 Set).		
11121 Smart Fix 120mm Bracket (11203 Set).		
11122 Smart Fix 150mm Bracket (11204 Set).		
11123 Smart Fix 200mm Bracket (11205 Set).		
Square Smart Fix Brackets in white or silver		
11139 Smart Fix 60mm Bracket (11210 Set).		
11140 Smart Fix 80mm Bracket (11211 Set).		
11141 Smart Fix 100mm Bracket (11212 Set).		
11142 Smart Fix 120mm Bracket (11213 Set).		
11143 Smart Fix 150mm Bracket (11214 Set).		
11144 Smart Fix 200mm Bracket (11215 Set).		
Universal Smart Fix Extension Bracket in white or silver		
11154 Universal Smart Fix 120mm.		
11155 Universal Smart Fix 150mm.		
11156 Universal Smart Fix 200mm.		

Colours	Price Ctg.
Other colours special order - see Page 73.	E

Tools	Price Ctg.
	E

Bending	Max. trade discount	Price Ctg.
Angle bend £29.50 each. Semi-circle or gradual curve £38.00 each.	33 1/3%	

System Prices				Price Ctg.
Specific lengths charged at the nearest 25cm increment above.				A
cm	Standard Glider £	60mm Wave £	80mm Wave £	
125	41.06	61.22	55.10	
150	47.50	71.88	64.53	
175	54.98	83.27	74.70	
200	61.42	93.93	84.13	
225	68.90	105.32	94.30	
250	75.34	115.98	103.73	
275	82.82	127.37	113.90	
300	89.26	138.02	123.33	
325	96.74	149.42	133.50	
350	103.18	160.07	142.93	
375	110.66	171.47	153.10	
400	117.10	182.12	162.53	
425	124.58	193.52	172.70	
450	131.02	204.17	182.13	
475	138.51	215.56	192.30	
500	144.95	226.22	201.73	
525	152.43	237.61	211.90	
550	158.87	248.27	221.33	
575	166.35	259.66	231.50	
600	172.79	270.32	240.93	

Above prices are for systems ready-assembled. Substantial savings can be made for self-assembly. Rail can be supplied in full lengths or cut-to-size with accessories separately.

Enhanced Wave Options	Price Ctg.
Add the following to the systems prices above:	
<b>Option 1</b> 2255 Adjustable Brake Single-stack £7.40; Pair-stack £14.79	
<b>Option 2</b> 2255 Adjustable Brake & 6366 Carrier Single-stack £15.01; Pair-stack £30.01	
<b>Option 3</b> Enhanced Wave (80mm only) Single-stack £27.86; Pair-stack £55.72	

Rail and Standard Accessories	Price Ctg.
6466 Rail, white, available in 6 metre lengths.	A
3060 Clamp.	
6065 Twist eye end stop, 10, 100.	
6471 Endcover, white.	
Standard Gliders	
11301 2C Gliders in strip form, at 14 per m, outer 1000.	
Wave Gliders	
11302 Wave 2C Glider-cord 80mm.	
11303 Wave 2C Glider-cord 60mm.	

Optional Accessories		Price Ctg.
(additional charges may apply)		A
2255 Adjustable brake.		
3062 Connecting bridge.		
3582 Curtain hooks (each).		
3599 Hock. box, 100. Self-service sachets, 25 x 25. Outer, 25,000.		
6064 Endstop.		
6349 Wave® curtain tape.		
6364 Extension.		
6365 Hanger.		
6363 Iron-on hemming tape.		
6366 Draw rod carrier.		
10075 Lead curtain weight.		
10076 Fabric side weight.		
10430-10434 Draw rods, white or aluminium.		
11231 Recess profile.		
11237 Wedge.		
11239 Recess mask.		
1148C Screw.		

Colours	Price Ctg.
Other colours special order – consult Silent Gliss for pricing.	E

Bending	Max. trade discount	Price Ctg.
Angle bend £29.50 each. Semi-circle or gradual curve £38.00 each.	33 1/3%	

All prices shown exclude VAT



# Hand Operated Curtain Tracks

## SG 6820

(Available 1st May)

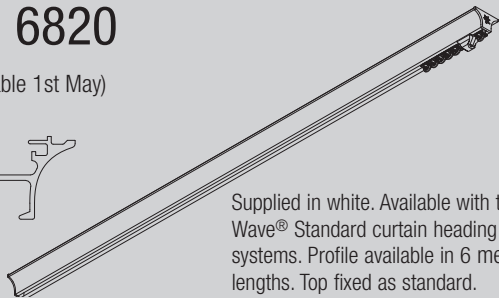
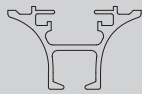

Supplied in white. Available with the Wave® Standard curtain heading systems. Profile available in 6 metre lengths. Top fixed as standard.

## SG 6840

Supplied in silver anodised, white, matt white, antique bronze, anodic grey and charcoal. Available with Wave® standard curtain headings systems. Top fix as standard.

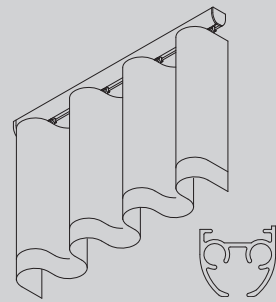

System Prices				Price Ctg.
Specific lengths charged at the nearest 25cm increment above.				A
cm	Standard Glider £	60mm Wave £	80mm Wave £	
125	58.59	78.17	76.76	
150	64.68	88.35	86.31	
175	74.04	101.50	99.03	
200	80.13	111.68	108.59	
225	89.49	124.84	121.31	
250	95.58	135.02	130.86	
275	104.94	148.17	143.58	
300	111.02	158.35	153.14	
325	120.38	171.51	165.86	
350	126.47	181.69	175.41	
375	135.83	194.84	188.13	
400	141.92	205.02	197.69	
425	151.28	218.18	210.41	
450	157.36	228.36	219.96	
475	166.72	241.51	232.68	
500	172.81	251.69	242.24	
525	182.17	264.85	254.96	
550	188.26	275.03	264.51	
575	197.62	288.19	277.23	
600	203.71	298.36	286.79	

Prices above are for systems ready-assembled. Substantial savings can be made for self-assembly. Rail can be supplied in full lengths or cut-to-size with accessories separately.

### Enhanced Wave Options

Add the following to the systems prices above:

- Option 1**  
2255 Adjustable Brake  
Single-stack £7.40; Pair-stack £14.79
- Option 2**  
2255 Adjustable Brake & 6366 Carrier  
Single-stack £15.01; Pair-stack £30.01
- Option 3**  
Enhanced Wave (80mm only)  
Single-stack £27.86; Pair-stack £55.72

Prices above are for systems ready-assembled. Substantial savings can be made for self-assembly. Rail can be supplied in full lengths or cut-to-size with accessories separately.

### Rail and Standard Accessories

- 6065 Endstop each, 10, 100.  
6821 Rail, white in 6m.  
6823 Endcover in white each, 10, 100.  
1148c Screw 31mm/1  
1148c Screw, 31mm/1/2", No. 8 countersunk, 100

### Standard Gliders

11301 2C Glider in strip form at 14 per m, outer 1000.

### Wave Gliders

- 11302 Wave 2C Glider cord 80mm.  
11303 Wave 2C Glider cord 60mm.

All prices shown exclude VAT

Optional Accessories		Price Ctg.
(additional charges may apply)		A
2255 Adjustable Brake.		
3582 Hook, Box, 100. Self service sachets, 25x25.Outer,1,000. Outer, 20,000.		
3599 Hook, box 100, outer 25,000.		
3802 Connecting Bridge.		
6007 Endstop white or silver.		
6053 Spring stop, 10.		
6065 Twist eye endstop, each, 10.		
6086 Spring stop, each 10, 100.		
6094 Roller glider with hook, 10, 100.		
6098 Roller glider with eye, 10,100.		
6146 Nylon hook only, 12, 100.		
6283 Roller glider, 10, 100.		
6349 Wave® curtain tape (per m).		
6363 Iron-on hemming tape.		
6364 Extension.		
6365 Hanger.		
6366 Draw rod carrier.		
10075 Lead curtain weight.		
10076 Fabric side weight.		
10430-10434 Draw Rods, white or aluminium.		

Colours		Price Ctg.
Other colours special order - see Page 69.		E

Bending		Price Ctg.
Max. trade discount		331/3%
Angle bend £46.00 each.		
Semi-circle or gradual curve £62.00 each.		

System Prices						Price Ctg.
Using Standard Gliders						A
cm	W/S		AB/CC		W/S	AB/CC
	£	£	£	£	£	£
125	51.79	74.18	63.23	85.06		
150	54.26	81.13	67.97	94.18		
175	62.49	93.84	78.59	109.10		
200	70.72	106.54	89.00	123.94		
225	78.95	119.25	99.55	138.79		
250	87.18	131.96	110.12	153.72		
275	92.66	141.92	117.80	165.82		
300	108.89	162.63	136.28	188.67		
325	109.59	167.81	139.32	196.07		
350	117.82	180.51	149.89	210.98		
375	123.53	190.71	157.88	223.28		
400	131.76	203.42	168.38	238.22		
425	139.99	216.13	178.91	253.13		
450	148.22	228.83	189.41	268.03		
475	153.94	239.03	197.46	280.36		
500	162.17	251.74	207.88	295.20		
525	170.40	264.45	218.40	310.13		
550	176.12	274.64	226.42	322.56		
575	184.35	287.35	236.99	337.35		
600	192.58	300.06	247.49	352.29		

Using Standard Wave Gliders					
cm	60mm glider cord		80mm glider cord		£
	W/S	AB/CC	W/S	AB/CC	
125	66.99	89.38	65.24	87.62	
150	76.11	102.98	74.20	101.07	
175	87.99	119.33	85.45	116.79	
200	99.86	135.68	96.68	132.51	
225	111.73	152.03	108.39	148.70	
250	123.60	168.39	119.63	164.42	
275	132.73	181.99	128.50	177.87	
300	152.60	206.34	147.84	201.58	
325	156.94	215.16	151.55	209.77	
350	168.81	231.51	163.26	225.96	
375	178.17	245.35	171.99	239.16	
400	190.04	261.70	183.23	254.88	
425	201.92	278.05	194.94	271.08	
450	213.79	294.40	206.18	286.79	
475	223.15	308.24	215.38	300.47	
500	235.02	324.59	226.62	316.19	
525	246.89	340.94	239.79	331.90	
550	256.25	354.78	247.06	347.62	
575	268.13	371.13	258.31	361.31	
600	280.00	387.48	269.55	377.03	

Using Wave Roller Gliders			
cm	80mm glider cord		
	W/S	MW/AG/AB/CC	£
125	115.40	137.23	
150	130.58	156.79	
175	151.64	182.14	
200	172.47	207.42	
225	193.47	232.71	
250	214.47	258.07	
275	232.58	280.61	
300	261.50	313.89	
325	274.97	331.72	
350	295.97	357.07	
375	314.41	379.80	
400	335.34	405.18	
425	356.30	430.53	
450	377.24	455.85	
475	395.73	478.62	
500	416.58	503.90	
525	437.53	529.26	
550	455.99	552.12	
575	476.99	577.36	
600	497.93	602.73	

Enhanced Wave Options	
Add the following to the systems prices above:	
<b>Option 1</b> 2255 Adjustable Brake Single-stack £7.40; Pair-stack £14.79	
<b>Option 2</b> 2255 Adjustable Brake & 6366 Carrier Single-stack £15.01; Pair-stack £30.01	
<b>Option 3</b> Enhanced Wave (80mm only) Single-stack £27.86; Pair-stack £55.72	

Rail and Standard Accessories		Price Ctg.
3825 Clamp, at 300mm centres, 10, 100.		A
3841 Rail, silver, white, matt white, antique bronze, anodic grey, charcoal available in 6m or cut-to-size.		
3842 Endcover.		
6065 Twist eye endstop, each, 10, 100.		
1148c Screw, 31mm/1/2", No. 8 countersunk, 100.		
Plus one of the following glider options:		
<b>Standard Gliders</b>		
11301 2C Gliders in strip form, at 14 per m, outer 1000.		
<b>Roller Gliders</b>		
6283 Roller gliders at 10 per m. Outer 10, 100.		
<b>Wave Gliders</b>		
11302 Wave 2C Glider-cord 80mm.		
11303 Wave 2C Glider-cord 60mm.		
6099 Roller glider-cord 80mm pitch. Outer of 50m.		
1148c Screw, 31mm/1/2", No. 8 countersunk, 100		

Optional Accessories		Price Ctg.
(additional charges may apply).		A
2255 Adjustable brake.		
3582 Hook, Box, 100. Self-service sachets, 25 x 25. Outer, 25,000.		
3599 Hook, Box, 100. Self service sachets, 25x25.Outer, 25,000.		
3802 Connecting bridge.		
3826W Nylon bracket, (top fix).		
3832 Clamp for top fixing.		
3836 Nylon bracket, (face fix).		
6053 Spring stop, 10.		
6094 Roller glider with hook, 10, 100.		
6098 Roller glider with eye.		
6349 Wave® curtain tape (per m).		
6364 Extension.		
6365 Hanger.		
6363 Iron-on hemming tape.		
6366 Draw rod carrier.		
10075 Lead curtain weight.		
10076 Fabric side weight.		
10430 - 10434 Draw rods, white or aluminium		

Smart Fix Brackets in white or silver	
11118 Smart Fix 60mm Bracket (11200 Set).	
11119 Smart Fix 80mm Bracket (11201 Set).	
11120 Smart Fix 100mm Bracket (11202 Set).	
11121 Smart Fix 120mm Bracket (11203 Set).	
11122 Smart Fix 150mm Bracket (11204 Set).	
11123 Smart Fix 200mm Bracket (11205 Set).	
Square Smart Fix Brackets in white or silver	
11139 Smart Fix 60mm Bracket (11210 Set).	
11140 Smart Fix 80mm Bracket (11211 Set).	
11141 Smart Fix 100mm Bracket (11212 Set).	
11142 Smart Fix 120mm Bracket (11213 Set).	
11143 Smart Fix 150mm Bracket (11214 Set).	
11144 Smart Fix 200mm Bracket (11215 Set).	
Smart Fix Brackets Covers	
11116 Smart Fix Bracket Cover.	
11137 Square Smart Fix Bracket Cover.	

Colours		Price Ctg.
Other colours special order - see page 73.		E

Tools		Price Ctg.
0538 Bending kit for use with 7103/7109.		E
7103 Portable hand operated bending tool.		
7109 Portable electrically operated bending tool.		
7802 Filler set 3840 at 200cm for 7103/9.		

Bending		Price Ctg.
Max. trade discount		331/3%
Angle bend £46.00 each.		
Semi-circle or gradual curve £62.00 each.		



# Hand Operated Curtain Tracks

## SG 6870

(Available 1st May)

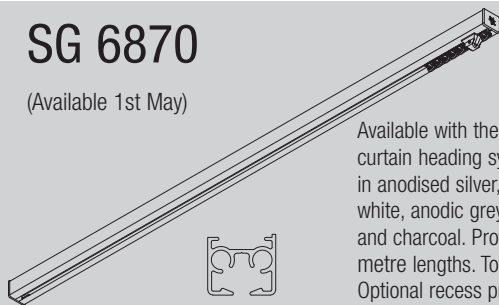

Available with the Wave® Standard curtain heading systems. Supplied in anodised silver, white, matt white, anodic grey, antique bronze and charcoal. Profile available in 6 metre lengths. Top fix as standard. Optional recess profile available.

## SG 6970

(Available 1st May)

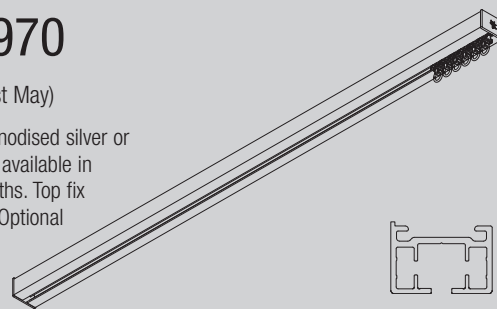

Supplied in anodised silver or white. Profile available in 6 metre lengths. Top fix as standard. Optional recess profile available.

	Price Ctgy.	<b>A</b>
--	----------------	----------

### System Prices

Specific lengths charged at the nearest 25cm increment above.

#### Using Standard Gliders

cm	W/S £	MW/AG/AB/CC £
125	55.92	78.60
150	61.95	88.67
175	70.59	101.35
200	76.62	111.42
225	85.26	124.11
250	91.29	134.18
275	99.94	146.86
300	105.96	156.93
325	114.61	169.61
350	120.64	179.68
375	129.28	192.36
400	135.31	202.44
425	143.95	215.12
450	149.98	225.19
475	158.62	237.87
500	164.65	247.94
525	173.29	260.62
550	179.32	270.69
575	187.96	283.38
600	193.99	293.45

#### Using 60mm Standard Wave Gliders

cm	W/S £	MW/AG/AB/CC £
125	75.50	101.15
150	85.62	115.74
175	98.06	132.72
200	108.18	147.31
225	120.61	164.29
250	130.74	178.88
275	143.17	195.86
300	153.29	210.45
325	165.73	227.43
350	175.85	242.02
375	188.29	259.00
400	198.41	273.59
425	210.85	290.57
450	220.97	305.16
475	233.41	322.14
500	243.53	336.73
525	255.97	353.71
550	266.09	368.30
575	278.53	385.28
600	288.65	399.87

#### Using 80mm Standard Wave Gliders

cm	W/S £	MW/AG/AB/CC £
125	73.46	95.04
150	82.89	108.41
175	94.78	124.17
200	104.21	137.54
225	116.09	153.30
250	125.53	166.67
275	137.41	182.42
300	146.84	195.79
325	158.73	211.55
350	168.16	224.92
375	180.04	240.68
400	189.48	254.05
425	201.36	269.81
450	210.80	283.18
475	222.68	298.93
500	232.11	312.30
525	243.99	328.06
550	253.43	341.43
575	265.31	357.19
600	274.75	370.56

Prices above are for systems ready-assembled. Substantial savings can be made for self-assembly. Rail can be supplied in full lengths or cut-to-size with accessories separately.

### Enhanced Wave Options

Add the following to the systems prices above:

- Option 1**  
2255 Adjustable Brake  
Single-stack £7.40; Pair-stack £14.79
- Option 2**  
2255 Adjustable Brake & 6366 Carrier  
Single-stack £15.01; Pair-stack £30.01
- Option 3**  
Enhanced Wave (80mm only)  
Single-stack £27.86; Pair-stack £55.72

All prices shown exclude VAT

	Price Ctgy.	<b>A</b>
--	----------------	----------

### Rail and Standard Accessories

- 3825 Clamp, 10, 100.  
6065 Endstop.  
11190 Profile, silver, white, matt white, anodic grey, antique bronze, charcoal in 6m.  
1148C Screw, 31mm/1 1/2", No. 8 countersunk, 100  
11233 Endcover silver, white, matt white, anodic grey, antique bronze, charcoal.  
**Standard Gliders**  
11301 2C Glider in strip form, at 14 per m, outer 1000.  
**Wave Gliders**  
11302 Wave 2C Glider-cord 80mm  
11303 Wave 2C Glider-cord 60mm

### Optional Accessories

- (additional charges may apply)  
2255 Adjustable Break.  
3582 Hook, Box, 100. Self service sachets, 25x25.Outer,1,000. Outer, 20,000.  
3599 Hook, box 100, outer 25,000.  
3802 Connecting Bridge.  
3826W Nylon bracket, (top fix).  
3832 Clamp for top fixing.  
3836 Nylon bracket, (face fix).  
6007 Endstop white or silver.  
6053 Spring stop, 10.  
6064 Endstop.  
6086 Spring stop, each 10, 100.  
6094 Roller glider with hook, 10, 100.  
6098 Roller glider with eye, 10,100.  
6146 Nylon hook only, 12, 100.  
6283 Roller glider, 10, 100.  
6349 Wave® curtain tape.  
6364 Extension.  
6365 Hanger.  
6366 Iron-on hemming tape.  
6366 Draw rod carrier.  
10075 Lead curtain weight.  
10076 Fabric side weight.  
10430-10434 Draw Rods, white or aluminium  
11230 Recess profile, white 6m  
11238 Recess Mask

- Smart Fix Brackets in white or silver**  
11118 Smart Fix 60mm Bracket (11200 Set).  
11119 Smart Fix 80mm Bracket (11201 Set).  
11121 Smart Fix 120mm Bracket (11203 Set).  
11122 Smart Fix 150mm Bracket (11204 Set).  
11123 Smart Fix 200mm Bracket (11205 Set).  
**Square Smart Fix Brackets in white or silver**  
11139 Smart Fix 60mm Bracket (11210 Set).  
11140 Smart Fix 80mm Bracket (11211 Set).  
11141 Smart Fix 100mm Bracket (11212 Set).  
11142 Smart Fix 120mm Bracket (11213 Set).  
11143 Smart Fix 150mm Bracket (11214 Set).  
11144 Smart Fix 200mm Bracket (11215 Set).  
**Universal Smart Fix Extension Bracket in white or silver**  
11154 Universal Smart Fix 120mm.  
11155 Universal Smart Fix 150mm.  
11156 Universal Smart Fix 200mm.

10157 Wedge	Price Ctgy.	<b>C</b>
-------------	----------------	----------

<b>Colours</b> Other colours special order - see Page 73.	Price Ctgy.	<b>E</b>
--	----------------	----------

<b>Bending</b> Max. trade discount	Price Ctgy.	<b>33 1/3%</b>
---------------------------------------	----------------	----------------

Angle bend £46.00 each.  
Semi-circle or gradual curve £62.00 each.

	Price Ctgy.	<b>A</b>
--	----------------	----------

### System Prices

Specific lengths charged at the nearest 25cm increment above.

cm	Std 60mm 80mm		
	Roller Glider £	Wave Wave £	Roller Wave £
125	109.26	180.82	155.57
150	122.61	210.71	180.41
175	141.46	242.38	207.03
200	154.81	272.27	231.87
225	173.66	303.95	258.50
250	187.01	333.84	283.34
275	205.86	365.51	309.96
300	219.21	395.40	334.80
325	238.06	427.08	361.43
350	251.41	456.96	386.26
375	270.26	488.64	412.89
400	283.61	518.53	437.73
425	302.46	550.20	464.35
450	315.81	580.09	489.19
475	334.66	611.77	515.82
500	348.01	641.66	540.66
525	366.86	673.33	567.28
550	380.21	703.22	592.12
575	399.06	734.90	618.75
600	412.41	764.79	643.59

Prices above are for systems ready-assembled. Substantial savings can be made for self-assembly. Rail can be supplied in full lengths or cut-to-size with accessories separately.

<b>Rail and Standard Accessories</b>	Price Ctgy.	<b>A</b>
--------------------------------------	----------------	----------

- 3004 Clamps, 10, 100.  
6007 Endstop white.  
11235 Endcover silver and white.

10840 Roller glider, at 10 per m, outer 10, 100. 10850 Rail, Silver and White in 6m. 10852 Wave 2C Roller Cord 80mm. 10869 Wave 2C Roller Cord 60mm.	Price Ctgy.	<b>C</b>
---	----------------	----------

	Price Ctgy.	<b>A</b>
--	----------------	----------

### Optional Accessories

(additional charges may apply)

- 3041 Bracket.  
3582 Curtain hook, box, 100  
Self service sachets, 25 x 25. Outer, 20,000.  
6349 Wave® curtain tape.  
6364 Extension.  
6363 Iron-on hemming tape.  
6365 Hanger.  
6366 Draw rod carrier.  
7002 Profile protector.  
10075 Lead weight 50/gr/m.  
10076 Fabric weight.  
10430-10434 Draw Rods, white or aluminium.  
**Smart Fix Brackets in white or silver**  
11118 Smart Fix 60mm Bracket (11200 Set).  
11119 Smart Fix 80mm Bracket (11201 Set).  
11121 Smart Fix 120mm Bracket (11203 Set).  
11122 Smart Fix 150mm Bracket (11204 Set).  
11123 Smart Fix 200mm Bracket (11205 Set).  
**Square Smart Fix Brackets in white or silver**  
11139 Smart Fix 60mm Bracket (11210 Set).  
11140 Smart Fix 80mm Bracket (11211 Set).  
11141 Smart Fix 100mm Bracket (11212 Set).  
11142 Smart Fix 120mm Bracket (11213 Set).  
11143 Smart Fix 150mm Bracket (11214 Set).  
11144 Smart Fix 200mm Bracket (11215 Set).  
**Universal Smart Fix Extension Brackets in white or silver**  
11154 Universal Smart Fix 120mm.  
11155 Universal Smart Fix 150mm.  
11156 Universal Smart Fix 200mm.

5118 Wedge for recess profile. 10831 Connecting Bridge. 10862 Recess profile, white, per meter. 10864 Recess mask, belt return, white. 10865 Mounting support plate.	Price Ctgy.	<b>C</b>
--	----------------	----------

<b>Colours</b> Other colours special order - see Page 73.	Price Ctgy.	<b>E</b>
--	----------------	----------

<b>Bends</b>	<b>Max. trade discount</b>	25%
For each bend add the following to above system price:		
Radius/cm		
25-99	£139.00 each.	
Over 99	£261.00 each.	



# Cord Operated Curtain Tracks

## SG 3000

Supplied in white. Profile available in 5 or 6 metre lengths.

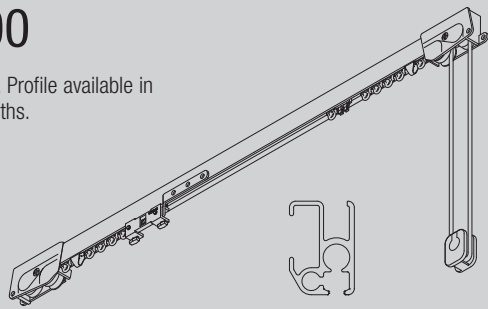

## SG 3840

Supplied in anodised silver, white, matt white, anodic grey, antique bronze and charcoal. Available in 6 metre lengths only. Available with the Wave® Standard curtain heading systems. Top fixed as standard.

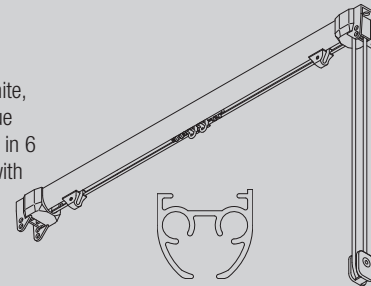

System Prices		Price Ctg.
Specific lengths charged at the nearest 25cm increment above.		<b>A</b>
cm	White £	
125	86.54	
150	92.54	
175	98.56	
200	104.62	
225	110.58	
250	116.60	
275	122.62	
300	128.63	
325	134.61	
350	140.61	
375	146.67	
400	152.68	
425	158.70	
450	164.66	
475	170.73	
500	176.72	
525	182.72	
550	188.75	
575	194.73	
600	200.75	

Above prices are for systems ready-assembled. Substantial savings can be made for self-assembly. Rail can be supplied in full lengths or cut-to-size with accessories separately.

Rail and Standard Accessories		Price Ctg.
18R Screw 25mm/1", No. 8 round head, 100.		<b>A</b>
1082 Rail, white in 5m, 6m.		
1105 Spacer for cord pull end.		
1348R Screw round head No. 8 44mm/1 3/4" for spacer 1105, 100.		
3070 Twist eye endstop, each 10.		
3090 Cord 100, metres, 500 metres.		
3242 Overlap, each, 10, 100.		
Euroslot sachet 1.		
3288 Pair of endpieces, including Pilot runners 3030/3213, white. Outer, 25 sets, per set.		
3533 Glider. Box, 100. Self-service sachets, 25 x 25. Outer, 25,000.		
Euroslot sachet 25.		
3534 Glider, in strip form, 16 per metre. Outer, 1,000 gliders.		
3630 Universal bracket, white, each, 10, 100, Euroslot sachet 2.		

Tools		Price Ctg.
10400 Cord retainer		<b>E</b>
SL3000 Reel, sleeving.		
SL3000W Reel, sleeving.		
80018 Slotting tool.		
7103 Portable hand operated bending tool.		
7004 Cording needle.		
7109 Portable electrically operated bending tool.		
Instruction leaflet.		
7805 Filler set 3000 at 200cm for 7103/9.		
0540 Bending tool for gradual curves.		

Optional Accessories		Price Ctg.
(Additional charges may apply)		<b>A</b>
1128R Screw 36mm/1 1/2", No. 8 round head, 100.		
3020 Hook. Metal, 100.		
3032 Springstop, 10, 100.		
3045 Metal overlap arm, each, 10.		
3151 Clearance spacer (for top boards).		
3208 Intermediate pulley, white, grey, antique bronze, black, gold, each, 10.		
3231 End fixing bracket, each, 10.		
3289/3289W Set end pieces with return, including pilot runners, set.		
3511 Glider, at 16 per metre, 100. Outer, 25,000 gliders.		
3562 Standard tape, 100 metres.		
3570 Rotating glider, 100.		
3571 Hook. Box 100. Self-service sachets, 25 x 25. Outer 35,000.		
Euroslot sachet 25.		
3582 Hook. Box, 100 Self-service sachets, 25 x 25. Euroslot sachets 25. Outer, 1000. Outer, 20,000.		
3599 Hook. Box, 100. Self-service sachets, 25 x 25. Euroslot sachet 25. Outer, 25,000.		
3603 Top fix brackets, white at 600mm centres each, 100. Euroslot sachet 2.		
3615 Clamp.		
3620 Connecting bridge, each.		
3655 Long universal bracket.		
3660 Extra long universal bracket.		
Smart Fix Brackets in white or silver		
11118 Smart Fix 60mm Bracket (11200 Set).		
11119 Smart Fix 80mm Bracket (11201 Set).		
11120 Smart Fix 100mm Bracket (11202 Set).		
11121 Smart Fix 120mm Bracket (11203 Set).		
11122 Smart Fix 150mm Bracket (11204 Set).		
11123 Smart Fix 200mm Bracket (11205 Set).		
Square Smart Fix Brackets in white or silver		
11139 Smart Fix 60mm Bracket (11210 Set).		
11140 Smart Fix 80mm Bracket (11211 Set).		
11141 Smart Fix 100mm Bracket (11212 Set).		
11142 Smart Fix 120mm Bracket (11213 Set).		
11143 Smart Fix 150mm Bracket (11214 Set).		
11144 Smart Fix 200mm Bracket (11215 Set).		
Smart Fix Bracket Covers		
11116 Smart Fix Bracket Cover.		
11137 Square Smart Fix Bracket Cover.		

Colours		Price Ctg.
Other colours special order - see page 73.		<b>E</b>

Tools		Price Ctg.
7103 Portable hand operated bending tool.		<b>E</b>
7004 Cording needle.		
7109 Portable electrically operated bending tool.		
Instruction leaflet.		
7805 Filler set 3000 at 200cm for 7103/9.		
0540 Bending tool for gradual curves.		

Bending		Price Ctg.
Max. trade discount	33 1/3%	
Angle bend £34.00 each.		
Semi-circle or gradual curve £50.00 each.		

System Prices				Price Ctg.
Using Standard Gliders				<b>A</b>
cm	W/S £	MW/AG/AB/CC £	W/S £	MW/AG/AB/CC £
125	83.58	107.92	95.02	119.36
150	92.00	119.84	105.71	133.56
175	100.32	131.74	116.43	147.86
200	108.77	143.72	127.03	161.99
225	117.17	155.63	137.77	176.24
250	125.53	167.53	148.46	190.46
275	133.94	179.49	159.06	204.62
300	142.36	191.39	169.75	218.78
325	150.67	203.32	180.38	235.12
350	159.06	215.21	191.16	247.27
375	167.46	227.17	201.81	261.53
400	175.87	239.08	212.48	275.69
425	184.23	250.98	223.15	289.90
450	192.65	262.90	233.83	304.08
475	201.00	274.82	244.53	318.34
500	209.47	286.77	255.19	332.47
525	217.83	298.68	265.84	346.67
550	226.23	310.59	276.52	360.87
575	234.60	322.55	287.24	375.20
600	243.02	334.43	297.93	389.34

Using Standard Wave Gliders					
cm	60mm glider-cord		80mm glider-cord		£
	W/S £	MW/AG/AB/CC £	W/S £	MW/AG/AB/CC £	
125	102.11	126.45	98.60	122.94	
150	114.22	142.07	110.20	138.05	
175	126.26	157.67	121.25	152.67	
200	138.40	173.35	132.41	167.37	
225	150.50	188.98	143.99	182.39	
250	162.57	204.56	155.09	197.08	
275	174.68	220.23	166.68	212.24	
300	186.81	235.84	177.83	226.87	
325	198.82	251.48	188.85	241.51	
350	210.93	267.07	200.46	256.58	
375	223.03	282.74	211.56	271.27	
400	235.14	298.35	222.70	285.90	
425	247.20	313.96	234.24	301.00	
450	259.32	329.57	245.39	315.63	
475	271.39	345.21	256.93	330.75	
500	283.57	360.85	268.13	345.42	
525	295.64	376.47	279.22	360.05	
550	307.73	392.08	290.79	375.15	
575	319.79	407.76	301.89	389.85	
600	331.92	423.33	313.02	404.44	

Using Wave Roller Gliders			
cm	80mm glider cord		£
	W/S £	MW/AG/AB/CC £	
125	147.20	171.54	
150	168.31	196.16	
175	189.48	220.89	
200	210.52	245.47	
225	231.68	270.15	
250	252.81	294.81	
275	273.86	319.41	
300	294.97	344.00	
325	316.05	368.71	
350	337.23	393.36	
375	358.33	418.04	
400	379.44	442.65	
425	400.53	467.30	
450	421.66	491.90	
475	442.79	516.61	
500	463.88	541.17	
525	484.97	565.80	
550	506.10	590.45	
575	527.23	615.20	
600	548.37	639.78	

Track lengths between those specified will be charged at the rate for the nearest standard length above.

Above prices are for systems ready-assembled. Substantial savings can be made for self-assembly. Rail can be supplied in full lengths or cut-to-size with accessories separately.

All prices shown exclude VAT





# Cord Operated Curtain Tracks

## SG 3840

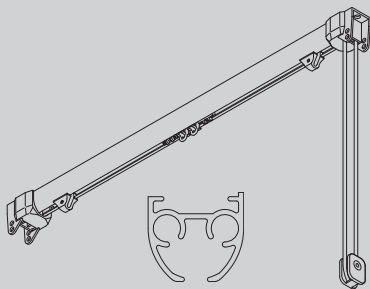

## SG 3870

(Available 1st May)

Supplied in anodised silver, white, matt white, anodic grey, antique bronze and charcoal. Available with the Wave® Standard curtain heading systems. Available in 6 metre lengths. Top fix as standard. Optional recess profile available.

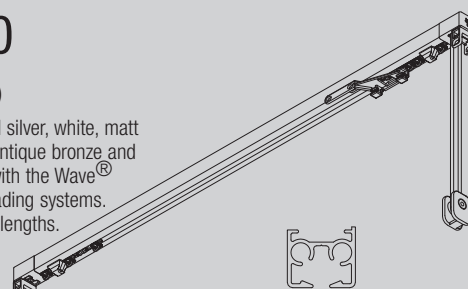

	Price Ctg.
<b>Rail and Standard Accessories</b>	<b>A</b>
1148C Screw, 31mm/1 1/4", No. 8 countersunk, 100.	
3090 Cord, 100 metres. 500 metres.	
3825 Clamp, 10, 100.	
3841 Rail, silver, white, matt white, anodic grey, antique bronze, charcoal available in 6m.	
3845 Endpiece set, white, grey, matt white, anodic grey, antique bronze, charcoal.	
6086 Spring stop, each 10, 100.	
6288 Plastic overlap arm, each, 10.	
Plus one of the following glider options:	
<b>Standard Gliders</b>	
11301 2C Gliders in strip form, at 14 per m, outer 1000.	
<b>Roller Gliders</b>	
6283 Roller glider at 10 per metre. Outer 10, 100.	
<b>Wave Gliders</b>	
6099 Roller glider-cord 80mm pitch. Outer of 50mm.	
11302 2C Wave glider-cord 80mm	
11303 2C Wave glider-cord 60mm	
10400 Cord retainer	
10483 Child safety device (only applicable for complete systems with curtains by Silent Gliss).	<b>E</b>
<b>Optional Accessories</b> (additional charges may apply).	<b>A</b>
3020 Hook. Metal, 100.	
3562 Standard tape, 100 metres.	
3571 Hook. Box 100. Self-service sachets, 25 x 25. Outer, 35,000.	
3582 Curtain hooks (each).	
3582 Hook. Box, 100. Self-service sachets, 25 x 25. Outer, 20,000.	
3599 Hook. Box 100. Self-service sachets, 25 x 25. Outer, 25,000.	
3802 Connecting bridge, each.	
3826W Nylon bracket, (top fix).	
3832 Clamp for top fixing.	
3833A Intermediate pulley, white, each.	
3836 Nylon bracket, (face fix).	
3846 Endpieces set with return including pair of pilot runners and 2 x 3816 endpieces, white.	
6063 Overlap arm, each, 10.	
6094 Roller glider with hook, 10, 100.	
6098 Roller glider with eye.	
6099 Roller glider cord 80mm.	
6349 Wave® curtain tape (per m).	
6363 Iron-on hemming tape.	
6364 Extension.	
6365 Hanger.	

	Price Ctg.
<b>Smart Fix Brackets in white or silver</b>	<b>A</b>
11118 Smart Fix 60mm Bracket (11200 Set).	
11119 Smart Fix 80mm Bracket (11201 Set).	
11120 Smart Fix 100mm Bracket (11202 Set).	
11121 Smart Fix 120mm Bracket (11203 Set).	
11122 Smart Fix 150mm Bracket (11204 Set).	
11123 Smart Fix 200mm Bracket (11205 Set).	
<b>Square Smart Fix Brackets in white or silver</b>	
11139 Smart Fix 60mm Bracket (11210 Set).	
11140 Smart Fix 80mm Bracket (11211 Set).	
11141 Smart Fix 100mm Bracket (11212 Set).	
11142 Smart Fix 120mm Bracket (11213 Set).	
11143 Smart Fix 150mm Bracket (11214 Set).	
11144 Smart Fix 200mm Bracket (11215 Set).	
<b>Smart Fix Bracket Covers</b>	
11116 Smart Fix Bracket Cover.	
11137 Square Smart Fix Bracket Cover.	
<b>Universal Smart Fix Extension Bracket in white or silver</b>	
11154 Universal Smart Fix 120mm.	
11155 Universal Smart Fix 150mm.	
11156 Universal Smart Fix 200mm.	
<b>Colours</b>	<b>E</b>
Other colours special order – see page 73.	
<b>Tools</b>	<b>E</b>
7103 Portable hand operated bending tool.	
7109 Portable electrically operated bending tool.	
7802 Filler set 3840 at 200cm for 7103/9.	
<b>Enhanced Wave® System supplement per system £</b>	
80mm Single-stack 17.67	
80mm Pair-stack 35.35	
<b>Bending Max. trade discount 33 1/3%</b>	
Angle bend £46.00 each.	
Semi-circle or gradual curve £62.00 each.	

	Price Ctg.
<b>System Prices</b>	<b>A</b>
Specific lengths charged at the nearest 25cm increment above.	
<b>Using Standard Gliders</b>	
cm W/S MW/AG/AB/CC £	
125 89.22 117.12	
150 96.22 127.95	
175 105.92 141.41	
200 112.92 152.25	
225 122.62 165.71	
250 129.62 176.54	
275 139.33 190.00	
300 146.33 200.84	
325 156.03 214.29	
350 163.03 225.13	
375 172.73 238.59	
400 179.73 249.42	
425 189.44 262.88	
450 196.44 273.72	
475 206.14 287.18	
500 213.14 298.01	
525 222.84 311.47	
550 229.84 322.31	
575 239.55 335.76	
600 246.55 346.60	
<b>Using 60mm Standard Wave Gliders</b>	
cm W/S MW/AG/AB/CC £	
125 109.38 136.69	
150 120.60 151.62	
175 134.22 168.87	
200 145.43 183.80	
225 159.05 201.06	
250 170.26 215.98	
275 183.88 233.24	
300 195.09 248.16	
325 208.71 265.42	
350 219.92 280.35	
375 233.54 297.60	
400 244.75 312.53	
425 258.37 329.79	
450 269.58 344.71	
475 283.20 361.97	
500 294.41 376.89	
525 308.03 394.15	
550 319.24 409.08	
575 332.86 426.33	
600 344.07 441.26	
<b>Using 80mm Standard Wave Gliders</b>	
cm W/S MW/AG/AB/CC £	
125 103.28 130.76	
150 113.27 144.51	
175 125.67 160.58	
200 135.66 174.32	
225 148.05 190.39	
250 158.05 204.13	
275 170.44 220.20	
300 180.44 233.94	
325 192.83 250.01	
350 202.82 263.75	
375 215.22 279.82	
400 225.21 293.56	
425 237.61 309.64	
450 247.60 323.38	
475 259.99 339.45	
500 269.99 353.19	
525 282.38 369.26	
550 292.38 383.00	
575 304.77 399.07	
600 314.76 412.81	
Prices above are for systems ready-assembled. Substantial savings can be made for self-assembly. Rail can be supplied in full lengths or cut-to-size with accessories separately.	
<b>Enhanced Wave® System supplement per system £</b>	
80mm Single-stack 17.67	
80mm Pair-stack 35.35	

	Price Ctg.
<b>Rail &amp; Standard Accessories</b>	
3090 Cord 100, metres, 500 metres.	
3825 Clamp at 30cm intervals, 10, 100.	
6086 Spring stop, each 10, 100.	
6288 Plastic overlap arm, each, 10.	
11190 Rail, silver, white, matt white, anodic grey, antique bronze, charcoal in 6m.	
11285 Guide set, silver, white, matt white, anodic grey, antique bronze, charcoal.	
1148C Screw, 31mm/1 1/4", No. 8 countersunk, 100.	
<b>Standard Gliders</b>	
11301 2C Glider in strip form, at 14 per m, outer 1000.	
<b>Wave Gliders</b>	
11302 Wave 2C Glider-cord 80mm	
11303 Wave 2C Glider-cord 60mm	
10400 Cord retainer.	
10483 Child safety device (only applicable for complete systems with curtains by Silent Gliss).	<b>E</b>
<b>Optional Accessories</b> (Additional charges may apply)	<b>A</b>
3020 Hook. Metal, 100.	
3571 Hook. Box, 100. Self-service sachets, 25 x 25. Outer, 35,000.	
3582 Hook. Box, 100. Self-service sachets, 25 x 25. Outer, 25,000.	
3599 Hook. Box, 100. Self-service sachets, 25 x 25. Outer, 25,000.	
3802 Connecting bridge, each.	
3826W Nylon bracket, (top fix).	
3832 Clamp for top fixing.	
3836 Nylon bracket, (face fix).	
6007 Endstop, each 10.	
6053 Spring Stop, 10.	
6063 Overlap arm, each, 10.	
6064 Endstop.	
6065 Twist eye endstop, each, 10.	
6094 Roller glider with hook, 10, 100.	
6098 Roller glider with eye, 10, 100.	
6283 Roller glider, 10, 100.	
6349 Wave® curtain tape (per m).	
6363 Iron-on hemming tape.	
6364 Extension.	
6365 Hanger.	
10075 Lead weight 50 gr/m.	
10076 Fabric weight.	
11230 Recess profile white in 6m.	
11238 Recess mask.	
<b>Smart Fix Brackets in white or silver</b>	
11118 Smart Fix 60mm Bracket (11200 Set).	
11119 Smart Fix 80mm Bracket (11201 Set).	
11120 Smart Fix 100mm Bracket (11202 Set).	
11121 Smart Fix 120mm Bracket (11203 Set).	
11122 Smart Fix 150mm Bracket (11204 Set).	
11123 Smart Fix 200mm Bracket (11205 Set).	
<b>Square Smart Fix Brackets in white or silver</b>	
11139 Smart Fix 60mm Bracket (11210 Set).	
11140 Smart Fix 80mm Bracket (11211 Set).	
11141 Smart Fix 100mm Bracket (11212 Set).	
11142 Smart Fix 120mm Bracket (11213 Set).	
11143 Smart Fix 150mm Bracket (11214 Set).	
11144 Smart Fix 200mm Bracket (11215 Set).	
<b>Smart Fix Bracket Covers</b>	
11116 Smart Fix Bracket Cover.	
11137 Square Smart Fix Bracket Cover.	
<b>Universal Smart Fix Extension Bracket in white or silver</b>	
11154 Universal Smart Fix 120mm.	
11155 Universal Smart Fix 150mm.	
11156 Universal Smart Fix 200mm.	
10157 Wedge for recess profile.	<b>C</b>
<b>Colours</b>	<b>E</b>
Other colours special order - see Page 73.	
<b>Bending</b>	
Max. trade discount 33 1/3%	
Angle bend £46.00 each.	
Semi-circle or gradual curve £62.00 each.	

All prices shown exclude VAT





# Cord Operated Curtain Tracks

## SG 3900

Supplied in White. Profile available in 5 metre or 6 metre lengths.

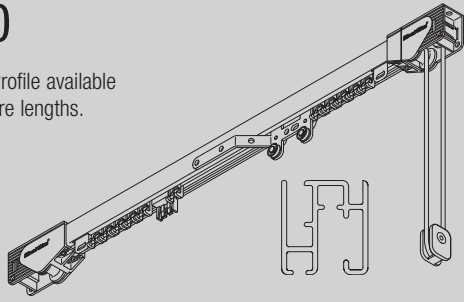

	Price Ctg.		Price Ctg.																																										
<b>System Prices</b> Specific lengths charged at the nearest 25cm increment above. <table border="1"> <thead> <tr> <th>cm</th> <th>White £</th> </tr> </thead> <tbody> <tr><td>125</td><td>87.08</td></tr> <tr><td>150</td><td>95.61</td></tr> <tr><td>175</td><td>104.23</td></tr> <tr><td>200</td><td>112.73</td></tr> <tr><td>225</td><td>121.38</td></tr> <tr><td>250</td><td>129.92</td></tr> <tr><td>275</td><td>138.52</td></tr> <tr><td>300</td><td>147.10</td></tr> <tr><td>325</td><td>155.64</td></tr> <tr><td>350</td><td>164.23</td></tr> <tr><td>375</td><td>172.83</td></tr> <tr><td>400</td><td>181.39</td></tr> <tr><td>425</td><td>189.92</td></tr> <tr><td>450</td><td>198.53</td></tr> <tr><td>475</td><td>207.11</td></tr> <tr><td>500</td><td>215.69</td></tr> <tr><td>525</td><td>224.22</td></tr> <tr><td>550</td><td>232.83</td></tr> <tr><td>575</td><td>241.39</td></tr> <tr><td>600</td><td>249.91</td></tr> </tbody> </table>	cm	White £	125	87.08	150	95.61	175	104.23	200	112.73	225	121.38	250	129.92	275	138.52	300	147.10	325	155.64	350	164.23	375	172.83	400	181.39	425	189.92	450	198.53	475	207.11	500	215.69	525	224.22	550	232.83	575	241.39	600	249.91	<b>A</b>	<b>Optional Accessories</b> (additional charges may apply) 3582 Hook, box 100, outer 1,000, outer 20,000. 3599 Hook, box 100, outer, 25,000. 3603 Top fix bracket, white, at 600mm centres, outer of 100. 3151 Clearance spacer (for top boards). 3620 Connecting bridge, each. 3655 Long universal bracket. 3660 Extra long universal bracket, each. 3914 Bracket for return profile, each. 3916 Pilot runner for multi stack system. 3929 Intermediate pulley, white, each 10. 3932 Spring stop, each 10. 3935 Straight overlap arm, each, 10. 3639 Hanger assembly complete, each.  <b>Smart Fix Brackets in white or silver</b> 11118 Smart Fix 60mm Bracket (11200 Set). 11119 Smart Fix 80mm Bracket (11201 Set). 11120 Smart Fix 100mm Bracket (11202 Set). 11121 Smart Fix 120mm Bracket (11203 Set). 11122 Smart Fix 150mm Bracket (11204 Set). 11123 Smart Fix 200mm Bracket (11205 Set).  <b>Square Smart Fix Brackets in white or silver</b> 11139 Smart Fix 60mm Bracket (11210 Set). 11140 Smart Fix 80mm Bracket (11211 Set). 11141 Smart Fix 100mm Bracket (11212 Set). 11142 Smart Fix 120mm Bracket (11213 Set). 11143 Smart Fix 150mm Bracket (11214 Set). 11144 Smart Fix 200mm Bracket (11215 Set).  <b>Smart Fix Bracket Covers</b> 11116 Smart Fix Bracket Cover. 11137 Square Smart Fix Bracket Cover.  <b>Universal Smart Fix Extension Bracket in white or silver</b> 11154 Universal Smart Fix 120mm. 11155 Universal Smart Fix 150mm. 11156 Universal Smart Fix 200mm.	<b>A</b>
cm	White £																																												
125	87.08																																												
150	95.61																																												
175	104.23																																												
200	112.73																																												
225	121.38																																												
250	129.92																																												
275	138.52																																												
300	147.10																																												
325	155.64																																												
350	164.23																																												
375	172.83																																												
400	181.39																																												
425	189.92																																												
450	198.53																																												
475	207.11																																												
500	215.69																																												
525	224.22																																												
550	232.83																																												
575	241.39																																												
600	249.91																																												
<b>Rail &amp; Standard Accessories</b> 18R Screw 25mm/1" No. 8 round head, 100. 3982W White rail, available in 5m or 6m lengths, in outers of 10 lengths only. 3630 Universal nylon bracket, white, at 600mm centres, 100. 3090 Cord, 100 metres, 500 metres. 3915 Endpiece set, incl. pilot runners 3939/3917, white, outer of 20 or 50 only. 3922 Roller glider in strip form at 10 per metre, outer of 1,000 gliders, outer of 6,000 gliders. 3936 Overlap arm, outer of 20 only.	<b>A</b>	<b>Tools</b> 7103 Portable hand operated bending tool. 7109 Portable electrically operated bending tool. 0545 Bending kit for 7103/7109 including filler set, blocks, arms and rings. 80018 Slotting tool. 7803 Filler set for 7103/7109, 200cm. 0540 Bending tool for gradual curves.	<b>E</b>																																										
10400 Cord retainer	<b>E</b>	<b>Bending</b> Max. trade discount 33 <sup>1</sup> / <sub>3</sub> %  Angle bend £46.00 each. Semi-circle or gradual curve £62.00 each.																																											

All prices shown exclude VAT



# Heavy Duty Curtain Tracks

## SG 3970

(Available 1st May)

Supplied in white. Profile available in 6 metre lengths. Top fix as standard. Optional recess profile available.

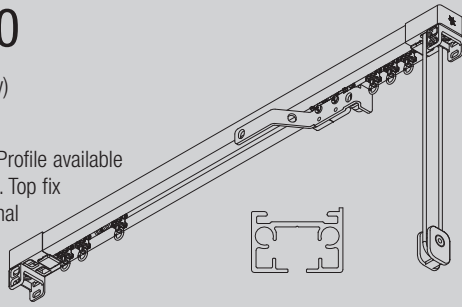

## SG 6370

Supplied in satin silver finish as standard. Profile available in 4, 5 and 6 metre lengths.

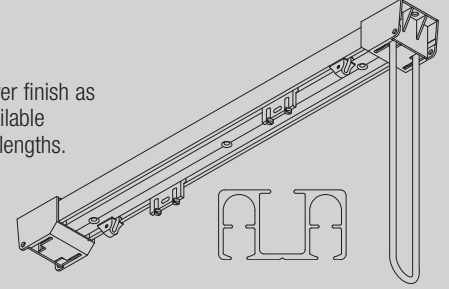

System Prices				Price Ctg.
Specific lengths charged at the nearest 25cm increment above.				C
cm	Standard Roller Gliders	Wave Roller Glider 60mm	Wave Roller Glider 80mm	
	£	£	£	
125	196.68	228.23	220.40	
150	211.48	255.35	244.79	
175	231.26	283.94	270.75	
200	246.06	311.06	295.15	
225	265.84	339.65	321.11	
250	280.65	366.77	345.51	
275	300.42	395.36	371.47	
300	315.23	422.48	395.86	
325	335.00	451.07	421.82	
350	349.81	478.19	446.22	
375	369.58	506.79	472.18	
400	384.39	533.91	496.58	
425	404.16	562.50	522.53	
450	418.97	589.62	546.93	
475	438.74	618.21	572.89	
500	453.55	645.33	597.29	
525	473.32	673.92	623.25	
550	488.13	701.04	647.64	
575	507.90	729.63	673.60	
600	522.71	756.75	698.00	

Prices above are for systems ready-assembled. Substantial savings can be made for self-assembly. Rail can be supplied in full lengths or cut-to-size with accessories separately.

### Rail & Standard Accessories

3004 Clamp, each, 10, 100.  
3090 Cord 100, metres, 500 metres.  
6007 Endstop, white.  
10854 Wave overlap support arm, white.

3971 Profile, white 6m.  
10821 Overlap arm, bent, white.  
10826 Overlap arm support set.  
10840 Roller glider, at 10 per m, outer 10, 100.  
10852 Wave roller glider cord (80mm pitch), 6.5mm channel.  
10887 Wave overlap arm set.  
10869 Wave roller glider cord (60mm pitch), 6.5mm channel.  
10845 Wave master carrier, single stack 80mm.  
10923 Pan head screw M4X12.  
11314 Master carrier.  
11315 Guide set, white.

10400 Cord retainer

Optional Accessories	Price Ctg.
(additional charges may apply)	A
3041 Bracket, each, 100.	
3582 Curtain hook, box, 100.	
Self-service sachets, 25 x 25.	
Outer, 20,000.	
6349 Wave® curtain tape.	
6363 Iron-on hemming tape.	
6365 Hanger.	
7002 Profile protector.	
10075 Lead weight 50 gr/m.	
10076 Fabric weight.	
10867 M4 x 16 screw.	
<b>Smart Fix Brackets in white or silver</b>	
11118 Smart Fix 60mm Bracket (11200 Set).	
11119 Smart Fix 80mm Bracket (11201 Set).	
11120 Smart Fix 100mm Bracket (11202 Set).	
11121 Smart Fix 120mm Bracket (11203 Set).	
11122 Smart Fix 150mm Bracket (11204 Set).	
11123 Smart Fix 200mm Bracket (11205 Set).	
<b>Square Smart Fix Brackets in white or silver</b>	
11139 Smart Fix 60mm Bracket (11210 Set).	
11140 Smart Fix 80mm Bracket (11211 Set).	
11141 Smart Fix 100mm Bracket (11212 Set).	
11142 Smart Fix 120mm Bracket (11213 Set).	
11143 Smart Fix 150mm Bracket (11214 Set).	
11144 Smart Fix 200mm Bracket (11215 Set).	
<b>Smart Fix Bracket Covers</b>	
11116 Smart Fix Bracket Cover.	
11137 Square Smart Fix Bracket Cover.	
<b>Universal Smart Fix Extension Bracket in white or silver</b>	
11154 Universal Smart Fix 120mm.	
11155 Universal Smart Fix 150mm.	
11156 Universal Smart Fix 200mm.	
5118 Wedge for recess profile.	
10820 Overlap arm, straight, white.	
10831 Connecting bridge.	
10862 Recess profile, white, per metre.	
10864 Recess mask, belt return, white.	
10865 Mounting support plate.	

11116 Smart Fix Bracket Cover.  
11137 Square Smart Fix Bracket Cover.

5118 Wedge for recess profile.  
10820 Overlap arm, straight, white.  
10831 Connecting bridge.  
10862 Recess profile, white, per metre.  
10864 Recess mask, belt return, white.  
10865 Mounting support plate.

### Colours

Other colours special order - see Page 73.

Bends	Max. trade discount	25%
For each bend add the following to above system price:		
Radius/cm		
25-99	£139.00 each.	
Over 99	£261.00 each.	

System Prices		Price Ctg.
Specific lengths charged at the nearest 25cm increment above.		C
cm	£	
300	350.46	
350	387.66	
400	424.95	
450	462.17	
500	499.43	
550	536.67	
600	573.94	
650	611.19	
700	648.41	
750	685.68	
800	722.88	
850	760.15	
900	797.40	
950	834.66	
1000	871.91	
1050	909.16	
1100	946.39	
1150	983.60	
1200	1020.89	
1250	1058.12	
1300	1095.38	
1350	1132.60	
1400	1169.88	
1450	1207.11	
1500	1244.35	

Connecting bridge included over 6m. Right hand pull as standard.

Above prices are for systems ready-assembled. Substantial savings can be made for self-assembly. Rail can be supplied in full lengths or cut-to-size with accessories separately.

### Rail and Standard Accessories

6070 Cord.  
6214 Adjustable pilot runner.  
6227 Master pilot runner.  
6371 Silver rail available in 4m, 5m, 6m or cut-to-size.  
6377 End piece set.

28C Screw countersunk, No. 8 2"/50mm.  
6086 Spring stop.  
6098 Roller glider with eye. 10 per metre.

10400 Cord retainer

Special Lengths charged at the nearest 50cm increment above.

Optional Accessories		Price Ctg.
(additional charges may apply)		C
6079 Overlap arm.		
6376 Connecting bridge.		
3599 Nylon hook.		A
6283 Roller glider.		
6369 Insert (Face Fix).		
<b>Universal Smart Fix Extension Bracket in white or silver</b>		
11154 Universal Smart Fix 120mm.		
11155 Universal Smart Fix 150mm.		
11156 Universal Smart Fix 200mm.		
<b>Colours</b>		E
Special order - see Page 73.		
<b>Bending</b>	Max. trade discount	25%
Standard right angle £118.50 each. Semi-circle or gradual curve £351.00 each.		

All prices shown exclude VAT



# Pole Systems – Metropole

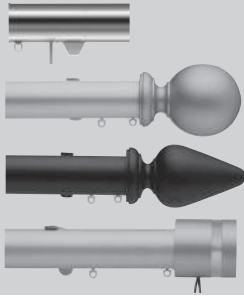

## **Metropole** by Silent Gliss

A decorative curtain pole concept combining beautifully crafted design details with contemporary finishes on our pole systems 1003/6120/6130 /6140/6150 and 6160.

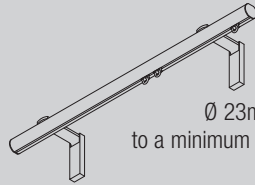

**SG 1003**

hand operated,  
Ø 23mm, can be bent  
to a minimum radius of 15cm.

Assembled systems below includes Smart Fix Set 11206 as standard.  
All bent poles are supplied with Smart Fix Set 11209 as standard.  
For additional bracket options please see page 13.

Metropole by Silent Gliss is based around our pole systems 1003/6130/6140 (hand drawn), 6120/6160 (cord drawn) and 6150 (electric). Select desired pole combination from our pole catalogue and find price below.

### SG 1003 HAND DRAWN Ø 23mm – SILVER/WHITE/MATT WHITE/ECRU

Price Category A

Size cm	125	150	175	200	225	250	275	300	325	350	375	400	425	450	475	500	525	550	575	600	
<b>Pole 1003 with</b>																					
<b>Flush/Stud endcap</b>	81.60	95.80	110.01	124.25	138.44	152.67	166.90	181.13	195.32	209.57	223.80	237.97	252.23	266.43	280.66	294.86	309.08	323.31	337.55	351.76	
<b>Pole 1003 inc. finials</b>																					
Crystal Cube (Green/Brown/Black)	180.94	195.14	209.36	223.59	237.79	252.01	266.24	280.47	294.66	308.92	323.14	337.31	351.57	365.77	380.01	394.20	408.43	422.65	436.90	451.10	
Crystal Cylinder (Green/Brown/Black)	195.07	209.28	223.49	237.72	251.92	266.14	280.38	294.60	308.79	323.05	337.27	351.45	365.70	379.91	394.14	408.33	422.56	436.78	451.03	465.23	
Shard Cylinder clear	160.29	174.49	188.71	202.94	217.13	231.36	245.44	259.82	274.01	288.27	302.49	316.66	330.92	345.12	359.36	373.55	387.77	402.00	416.24	430.44	
Shard Cylinder etched	178.34	192.55	206.76	221.00	235.19	249.41	263.65	277.87	292.07	306.32	320.55	334.72	348.97	363.18	377.41	391.61	405.83	420.05	434.30	448.50	
Groove Ball	166.50	180.70	194.92	209.15	223.35	237.57	251.80	266.01	280.22	294.48	308.70	322.87	337.13	351.33	365.57	379.76	393.99	408.21	422.45	436.66	
Groove Cylinder	119.86	134.06	148.28	162.51	176.71	190.93	205.17	219.39	233.58	247.84	262.06	276.24	290.49	305.72	318.93	333.12	347.35	361.57	375.82	390.02	
Fused Barrel - Walnut/Oak/Colour Matched	171.06	185.27	199.48	213.71	227.91	242.13	256.37	270.59	284.78	299.04	313.26	327.44	341.69	355.90	370.13	384.32	398.55	412.77	427.02	441.22	
Fused Ball - Walnut/Oak/Colour Matched	177.25	191.46	205.67	219.91	234.10	248.32	262.56	276.78	290.98	305.23	319.45	347.88	362.09	362.09	376.32	390.51	404.74	418.96	433.21	447.41	
Clear/Frosted Ball	182.63	196.83	211.05	225.28	239.48	253.70	267.93	282.16	296.35	310.61	324.83	339.00	353.26	367.46	381.70	395.89	410.12	424.34	438.58	452.79	

### SG 1003 HAND DRAWN Ø 23mm – GUNMETAL/CHARCOAL/CHROME

Size cm	125	150	175	200	225	250	275	300	325	350	375	400	425	450	475	500	525	550	575	600	
<b>Pole 1003 with</b>																					
<b>Flush/Stud endcap</b>	94.70	112.59	130.40	148.24	166.06	183.91	201.75	219.54	237.36	255.20	273.02	290.89	308.71	326.58	344.39	362.22	380.05	397.89	415.71	433.58	
<b>Pole 1003 inc. finials</b>																					
Crystal Cube (Green/Brown/Black)	194.04	211.93	229.74	247.58	265.40	283.25	301.09	318.89	336.71	354.55	372.37	390.24	408.06	425.93	443.73	461.56	479.39	497.23	515.05	532.92	
Crystal Cylinder (Green/Brown/Black)	216.34	234.23	252.04	269.88	287.77	305.55	323.39	341.19	359.01	376.85	394.67	412.54	430.35	448.23	466.03	483.86	501.69	519.53	537.35	555.22	
Shard Cylinder clear	173.39	191.28	209.09	226.93	244.75	262.60	280.44	298.24	316.06	333.90	351.71	369.58	387.40	405.27	423.08	440.91	458.74	476.58	494.40	512.27	
Shard Cylinder etched	191.45	209.34	227.15	244.99	262.80	280.65	298.49	316.29	334.11	351.95	369.77	387.64	405.46	423.33	441.14	458.97	476.80	494.64	512.46	530.33	
Groove Ball	179.60	197.49	215.30	233.14	250.96	268.81	286.65	304.45	322.27	340.11	357.93	375.80	393.61	411.49	429.29	447.12	464.95	482.79	500.61	518.48	
Groove Cylinder	132.96	150.85	168.66	186.50	204.32	222.17	240.01	257.81	275.63	293.47	311.29	329.16	346.98	364.85	382.66	400.48	418.31	436.15	453.97	471.84	
Fused Barrel - Walnut/Oak/Colour Matched	184.16	202.06	219.86	237.70	255.52	273.37	291.21	309.01	326.83	344.67	362.49	380.36	398.18	416.05	433.86	451.69	469.52	487.35	505.17	523.04	
Fused Ball - Colour Matched/Walnut/Oak	190.35	208.25	226.05	243.89	261.71	279.56	297.40	315.20	333.02	350.86	368.68	386.55	404.37	422.24	440.05	457.88	475.71	493.55	511.36	529.23	
Clear/Frosted Ball	195.73	213.62	231.43	249.27	267.09	284.94	302.78	320.58	338.40	356.24	374.05	391.93	409.74	427.61	445.42	463.25	481.08	498.92	516.74	534.61	

Chrome only available with Fused Ball/Barrel walnut/oak, colour matched not available.

Bending (Max. trade discount 33 1/3%) Angle bend: £30.50 each. Semi-circle or gradual curve: £47.50 each  
All bent poles are supplied with Smart Fix extension bracket set 11209.

All prices shown exclude VAT



# Pole Systems – Metropole

## Metropole by Silent Gliss

A decorative curtain pole concept combining beautifully crafted design details with contemporary finishes on our pole systems 1003/6120/6130 /6140/6150 and 6160.

All bent poles are supplied with adjustable brackets.

SG 6120 cord operated, Ø 30mm can be bent to a minimum radius of 30cm

Assembled systems below includes Smart Fix Set 11206 as standard.

All bent poles are supplied with Smart Fix Set 11209 as standard.

For additional bracket options please see page 13.

### SG 6120 CORD DRAWN Ø 30mm – BLACK/WHITE/MATT WHITE/ECRU Price Category A

Size cm	125	150	175	200	225	250	275	300	325	350	375	400	425	450	475	500	525	550	575	600
<b>Pole with standard cording set (2 no. flush/stud endcaps)</b>	179.40	198.28	217.28	236.20	255.11	274.10	292.99	311.72	330.90	349.82	368.75	387.69	406.63	425.55	444.50	463.44	482.36	501.29	520.25	539.17
<b>Pole 6120 inc. finials (2 no. per pole)</b>																				
Ball End	260.39	279.27	298.28	317.20	336.11	355.10	373.99	392.72	411.90	430.82	449.75	468.69	487.63	506.55	525.50	544.44	563.36	582.29	601.25	620.17
Spear	258.41	277.29	296.29	315.21	334.12	353.11	372.01	390.73	409.91	428.83	447.76	466.70	485.65	504.57	523.51	542.45	561.37	580.30	599.26	618.19
Crystal - Cube	310.30	329.18	348.18	367.10	386.01	405.01	423.90	442.62	461.80	480.72	499.65	518.59	537.54	556.46	575.40	594.34	613.26	632.19	651.16	670.08
Crystal - Cylinder	317.54	336.42	355.42	374.34	393.25	412.25	431.14	449.86	469.04	487.96	506.89	525.84	544.78	563.70	582.64	601.58	620.50	639.43	658.40	677.32
Strata - Clear/Ribbed	253.29	272.17	291.17	310.09	329.00	348.00	366.89	385.61	404.79	423.71	442.64	461.58	480.53	499.45	518.39	537.33	556.25	575.18	594.15	613.07
Strata - Coloured Disc	279.24	298.12	317.13	336.05	354.96	373.95	392.84	411.57	430.75	449.67	468.60	487.54	506.48	525.40	544.34	563.29	582.21	601.14	620.10	639.02
Groove - Ball	275.84	294.72	313.73	332.65	351.56	370.55	389.44	408.17	427.35	446.27	465.20	484.14	503.08	522.00	540.95	559.89	578.81	597.74	616.70	635.62
Groove - Cylinder	225.87	244.75	263.76	282.68	301.59	320.59	339.48	358.20	377.38	396.30	415.23	434.18	453.12	472.04	490.98	509.92	528.84	547.77	566.74	585.66
Shard - Clear	271.73	290.61	309.62	328.54	347.45	366.44	385.33	404.06	423.24	442.16	461.09	480.03	498.97	517.89	536.84	555.78	574.70	593.63	612.59	631.51
Shard - Etched	292.87	311.75	330.75	349.67	368.59	387.58	406.47	425.19	444.37	463.29	482.23	501.17	520.11	539.03	557.97	576.91	595.83	614.77	633.73	652.65
Design Endcap	214.94	233.82	252.82	271.74	290.66	309.65	328.54	347.26	366.44	385.36	404.30	423.24	442.18	461.10	480.04	498.98	517.90	536.84	555.80	574.72
Fused Barrel - Walnut/Oak/Colour Matched	285.32	304.19	323.18	342.12	361.04	380.02	398.91	417.63	436.82	455.75	474.65	493.62	512.57	531.48	550.42	569.35	588.28	607.21	626.18	645.09
Fused Ball - Walnut/Oak/Colour Matched	292.33	311.20	330.20	349.13	368.05	387.02	405.92	424.64	443.82	462.75	481.67	500.63	519.57	538.49	557.43	576.37	595.29	614.22	633.18	652.10
Fused Ball - Clear/Frosted	286.63	305.49	324.49	343.43	362.34	381.33	400.22	418.93	438.12	457.05	475.97	494.92	513.87	532.78	551.72	570.65	589.58	608.50	627.49	646.39

### SG 6120 CORD DRAWN Ø 30mm – OCHRE/GUNMETAL/BRONZE/ANTIQUE BRONZE/SAND/TAUPE/ANODIC GREY/CHARCOAL/SLATE GREY/CHROME (max 4m length)

Size cm	125	150	175	200	225	250	275	300	325	350	375	400	425	450	475	500	525	550	575	600
<b>Pole with standard cording set (2 no. flush/stud endcaps)</b>	203.13	226.87	250.52	274.23	297.91	321.63	345.35	368.97	392.67	416.36	440.08	463.78	487.42	511.11	534.87	558.50	582.20	605.89	629.59	653.26
<b>Pole 6120 inc. finials (2 no. per pole)</b>																				
Ball End	284.13	307.87	331.52	355.23	378.91	402.63	426.35	449.97	473.67	497.36	521.08	544.78	568.42	592.11	615.87	639.50	663.20	686.89	710.59	734.26
Spear*	282.14	305.88	329.53	353.24	376.92	400.64	424.36	447.98	471.68	495.37	519.09	542.79	566.43	590.12	613.88	637.51	661.21	684.90	708.60	732.27
Crystal - Cube	334.03	357.77	381.42	405.13	428.81	453.15	476.25	499.87	523.57	547.26	570.98	594.68	618.32	642.01	665.77	689.40	713.10	736.79	760.49	784.16
Crystal - Cylinder	351.10	374.84	398.49	422.20	445.88	469.60	493.32	516.94	540.64	564.33	588.05	611.75	635.39	659.08	682.84	706.47	730.17	753.86	777.56	801.23
Strata - Clear/Ribbed	277.02	300.76	324.41	348.12	371.80	395.52	419.24	442.86	466.56	490.25	513.97	537.67	561.31	585.00	608.76	632.39	656.09	679.78	703.48	727.15
Strata - Coloured Disc	302.97	326.72	350.36	374.08	397.76	421.48	445.20	468.81	492.52	516.21	539.93	563.63	587.26	600.65	634.72	658.35	682.05	705.74	729.44	753.11
Groove - Ball*	299.58	323.32	346.96	370.68	394.36	418.08	441.8	465.41	489.12	512.81	536.52	560.23	583.86	607.56	631.32	654.95	678.65	702.34	726.04	749.06
Groove - Cylinder*	249.61	273.35	297.00	320.71	344.39	368.11	391.83	415.45	439.15	462.84	486.56	510.26	533.90	557.59	581.35	604.98	628.68	652.37	676.07	699.74
Shard - Clear	295.47	319.21	342.86	366.57	390.25	413.97	437.69	461.31	485.01	508.70	532.42	556.12	579.76	603.45	627.21	650.84	674.54	698.23	721.93	745.60
Shard - Etched	316.60	340.34	363.99	387.70	411.38	435.10	458.82	482.44	506.14	529.83	553.55	577.25	600.89	624.58	648.34	671.97	695.67	719.36	743.06	766.73
Design Endcap	238.67	262.41	286.06	309.77	333.45	357.17	380.89	404.51	428.21	451.90	475.62	499.32	522.96	546.65	570.41	594.04	617.74	641.43	665.13	688.80
Fused Barrel - Walnut/Oak	309.06	332.79	356.44	380.15	403.82	427.55	451.25	474.89	498.59	522.28	545.99	569.70	593.34	617.03	640.79	664.42	688.12	711.81	735.50	759.18
Fused Ball - Colour Matched*	316.06	339.80	363.45	387.16	410.83	434.56	458.27	481.90	505.61	529.29	553.01	576.71	600.36	624.04	647.80	671.42	695.14	718.82	742.52	766.19
Clear/Frosted Ball	310.36	334.10	357.75	381.46	405.13	428.85	452.56	476.19	499.90	523.59	547.29	571.01	594.64	618.34	642.09	665.72	689.42	713.12	736.81	760.49

The above pricing includes standard glider (11301). For alternative glider options including wave and roller glider, please add the relevant price supplement below.

Size cm	125	150	175	200	225	250	275	300	325	350	375	400	425	450	475	500	525	550	575	600
<b>Roller-Glider Supplement</b>	18.54	22.24	25.95	29.66	33.37	37.07	40.78	44.49	48.19	51.90	55.61	59.32	63.02	66.73	70.44	74.14	77.85	81.56	85.27	88.97
<b>Wave™ Standard Supplement</b>																				
60mm Glider-cord	19.35	23.21	27.09	30.96	34.82	38.70	42.56	46.44	50.30	54.18	58.05	61.91	65.79	69.65	73.53	77.39	81.26	85.14	89.00	92.88
80mm Glider-cord	15.84	19.19	22.09	24.97	28.33	31.22	34.56	37.46	40.35	43.71	46.59	49.47	52.84	55.72	59.09	61.97	64.87	68.21	71.10	74.00
<b>Enhanced Wave Supplement (Please add the following to the above 80mm wave prices)</b>																				
Single Stack: £17.67    Pair Stack: £35.35																				
<b>Wave Roller-Glider Supplement (80mm)</b>	70.71	84.85	99.00	113.14	127.28	141.42	155.56	169.71	183.85	198.19	212.14	226.27	240.41	254.56	268.70	282.85	296.99	311.12	325.27	339.41

•Includes 1 x 10400 Cord retainer.  
 \*Spear on system 6120 and 6130 is not available in chrome finish.  
 Bending (Max. trade discount 331/3%) Angle bend: £72.00 each. Semi-circle or gradual curve: £97.50 each  
 Optional accessories see page 13.  
 All bent poles are supplied with Smart Fix extension bracket set 11209.  
 Child safety device (10483) – add on £9.54.  
 NOTE: Only applicable for complete systems with curtains by Silent Gliss.  
 Intermediate pulley 6165, see parts list for prices.

All prices shown exclude VAT



# Pole Systems – Metropole

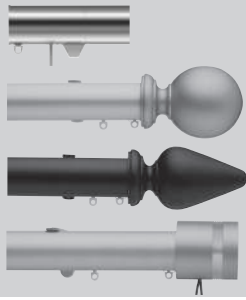

## Metropole by Silent Gliss

A decorative curtain pole concept combining beautifully crafted design details with contemporary finishes on our pole systems 1003/6120/6130 /6140/6150 and 6160

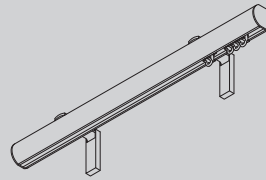

SG 6130 hand operated, Ø 30mm can be bent to a minimum radius of 30cm

Assembled systems below includes Smart Fix Set 11206 as standard.  
All bent poles are supplied with Smart Fix Set 11209 as standard.  
For additional bracket options please see page 13.

### SG 6130 HAND DRAWN Ø 30mm – SILVER/BLACK/WHITE/MATT WHITE/ECRU

Price Category A

Size (cm)	125	150	175	200	225	250	275	300	325	350	375	400	425	450	475	500	525	550	575	600
<b>Pole 6130 with Flush/Stud endcap</b>	102.62	117.33	131.97	146.63	161.34	176.01	190.61	205.29	219.89	234.62	241.79	263.89	278.54	293.21	307.88	322.52	337.14	351.83	366.48	381.16
<b>Pole 6130 inc. finials (2 no. per pole)</b>																				
Ball End	183.62	198.33	212.97	227.63	242.34	257.01	271.61	286.29	300.89	315.62	322.79	344.89	359.54	374.21	388.88	403.52	418.14	432.83	447.48	462.16
Spear	181.63	196.34	210.99	225.64	240.35	255.02	269.62	284.30	298.91	313.64	320.80	342.90	357.55	372.22	386.89	401.54	416.15	430.84	445.50	460.17
Crystal Cube	233.52	248.23	262.88	277.53	292.24	306.91	321.51	336.19	350.80	365.53	372.70	394.79	409.45	424.11	438.78	453.43	468.04	482.73	497.39	512.06
Crystal Cylinder	240.76	255.47	270.12	284.77	299.48	314.15	328.76	343.43	358.04	372.77	379.94	402.03	416.69	431.35	446.02	460.67	475.28	489.97	504.63	519.31
Strata - clear/ribbed disc	176.51	191.22	205.87	220.52	235.23	249.90	264.50	279.18	293.79	308.52	315.68	337.78	352.44	367.10	381.77	396.42	411.03	425.72	440.38	455.05
Strata - coloured disc	202.47	217.18	231.82	246.48	261.19	275.85	290.46	305.14	319.74	334.47	341.64	363.73	378.39	393.06	407.73	422.37	436.99	451.68	466.33	481.01
Groove Ball	199.07	213.78	228.42	243.08	257.79	272.46	287.06	301.74	316.34	331.07	338.24	360.34	374.99	389.66	404.33	418.97	433.59	448.28	462.93	477.61
Groove Cylinder	149.10	163.81	178.46	193.11	207.82	222.49	237.10	251.77	266.38	281.11	288.28	310.37	325.03	339.69	354.36	369.01	383.62	398.31	412.97	427.65
Shard Cylinder Clear	194.96	209.67	224.31	238.97	253.68	268.35	282.95	297.63	312.23	326.96	334.13	356.23	370.88	385.55	400.22	414.86	429.48	444.17	458.82	473.50
Shard Cylinder Etched	216.09	230.80	245.45	260.11	274.81	289.48	304.09	318.76	333.37	348.10	355.27	377.36	392.02	406.69	421.35	436.00	450.61	465.30	479.96	494.64
Design Endcap	138.16	152.87	167.52	182.18	196.88	211.55	226.16	240.83	255.44	270.17	277.34	299.43	314.09	328.76	343.42	358.07	372.68	387.37	402.03	416.71
Fused Barrel - Walnut/Oak/Matched	208.54	223.25	237.90	252.56	267.26	281.93	296.54	311.21	325.82	340.55	347.72	369.81	384.47	399.14	413.80	428.45	443.06	457.75	472.41	487.09
Fused Ball - Walnut/Oak/Matched	215.54	230.25	244.89	259.55	274.26	288.93	303.53	319.24	332.81	347.54	354.71	376.80	391.46	406.13	420.80	435.44	450.06	464.75	479.40	494.08
Clear/Frosted Ball	209.84	224.55	239.20	253.85	268.56	283.23	297.83	312.51	327.12	341.85	349.02	371.11	385.77	400.43	415.10	429.75	444.36	459.05	473.71	488.38

### SG 6130 HAND DRAWN Ø 30mm – CHROME (max 4m length)/GUNMETAL/BRONZE/ANTIQU BRONZE/SAND/TAUPE/ANODIC GREY/CHARCOAL/SLATE GREY/OCHRE

Size (cm)	125	150	175	200	225	250	275	300	325	350	375	400	425	450	475	500	525	550	575	600
<b>Pole 6130 with Flush/Stud endcap</b>	125.06	144.19	163.39	182.45	201.61	220.75	239.88	258.99	278.19	297.31	316.42	335.60	354.75	373.83	393.05	412.14	431.26	450.37	469.52	488.68
<b>Pole 6130 inc. finials (2 no. per pole)</b>																				
Overture Ball End	206.06	225.19	244.39	263.45	282.61	301.75	320.88	339.99	359.19	378.31	397.42	416.60	435.75	454.83	474.05	493.14	512.26	531.37	550.51	569.68
Spear*	204.07	223.20	242.40	261.47	280.62	299.76	318.89	338.00	357.20	376.32	395.43	414.62	433.76	452.84	472.06	491.16	510.27	529.38	548.53	567.69
Crystal Cube	255.97	275.09	294.29	313.36	332.51	351.65	370.78	389.90	409.10	428.21	447.32	466.51	485.66	504.73	523.95	543.05	562.16	581.27	600.42	619.59
Crystal Cylinder	273.03	292.16	311.36	330.42	349.58	368.72	387.85	406.96	426.16	445.28	464.39	483.57	502.72	521.80	541.02	560.11	579.23	598.34	617.49	636.65
Strata - clear/ribbed disc	198.95	218.08	237.28	256.35	275.50	294.64	313.77	332.89	352.08	371.20	390.31	409.50	428.64	447.72	466.94	486.04	505.15	524.26	543.41	562.58
Strata - coloured disc	224.91	244.04	263.24	282.30	301.46	320.60	339.72	358.84	378.04	397.16	416.26	435.45	454.60	473.68	492.90	511.99	531.11	550.22	569.36	588.53
Groove Ball	221.51	240.64	259.84	278.90	298.06	317.20	336.33	355.44	374.64	393.76	412.87	432.05	451.20	470.28	489.50	508.59	527.71	546.82	565.96	585.13
Groove Cylinder	171.55	190.67	209.87	228.94	248.10	267.23	286.36	305.48	324.68	343.79	362.90	382.09	401.24	420.31	439.53	458.63	477.74	497.31	516.00	535.17
Shard Cylinder Clear	217.40	236.53	255.73	274.79	293.95	313.09	332.22	351.33	370.53	389.65	408.76	427.94	447.09	466.17	485.39	504.48	523.60	542.71	561.85	581.02
Shard Cylinder Etched	238.54	257.66	276.86	295.93	315.09	334.22	353.35	372.47	391.67	410.78	429.89	449.08	468.23	487.30	506.52	525.62	544.74	563.84	582.99	602.16
Design Endcap	160.61	179.74	198.93	218.00	237.16	256.29	275.42	294.54	313.74	332.85	351.96	371.15	390.30	409.37	428.59	447.69	466.81	485.91	505.06	524.23
Fused Barrel - Walnut/Oak/Matched*	230.99	250.11	269.31	288.38	307.54	326.67	345.80	364.92	384.12	403.23	422.34	441.53	460.68	479.75	498.97	518.07	537.19	556.29	575.44	594.61
Fused Ball - Walnut/Oak/Matched*	237.98	257.11	276.31	296.40	314.53	333.67	352.80	371.91	391.11	410.23	429.33	448.52	467.67	486.75	505.97	525.06	544.18	563.29	582.43	601.60
Clear/Frosted Ball	232.29	251.41	270.61	289.68	308.84	327.97	347.10	366.22	385.42	404.53	423.64	442.83	461.98	481.05	500.27	519.37	538.48	557.59	576.74	595.91

The above pricing includes standard glider (11301). For alternatives add the relevant price supplement below.

Internal connecting bridge 6635 £19.40 each.

Bending 6130 (Max trade discount 33%). Angle bend £68.50 each. Semi circle or gradual curve £92.50 each.

All bent poles are supplied with Smart Fix extension bracket set 11209.

Size cm	125	150	175	200	225	250	275	300	325	350	375	400	425	450	475	500	525	550	575	600
<b>Roller-Glider Supplement</b>	18.54	22.24	25.95	29.66	33.37	37.07	40.78	44.49	48.19	51.90	55.61	59.32	63.02	66.73	70.44	74.14	77.85	81.56	85.27	88.97
<b>Wave™ Standard Supplement</b>																				
60mm Glider-cord	19.35	23.21	27.09	30.96	34.82	38.70	42.56	46.44	50.30	54.18	58.05	61.91	65.79	69.65	73.53	77.39	81.26	85.14	89.00	92.88
80mm Glider-cord	15.84	19.19	22.09	24.97	28.33	31.22	34.56	37.46	40.35	43.71	46.59	49.47	52.84	55.72	59.09	61.97	64.87	68.21	71.10	74.00
<b>Enhanced Wave Supplement (with added optional extras)</b>																				
<b>Please add the following to the above 80mm wave prices.</b>																				
<b>Option 1: 2255 Adjustable Brake</b>																				
Single Stack: £7.39																				
Pair Stack: £14.79																				
<b>Option 2: 2255 Adjustable Brake &amp; 6366 Carrier</b>																				
Single Stack: £15.00																				
Pair Stack: £30.00																				
<b>Option 3: Enhanced Wave (80mm only)</b>																				
Single Stack: £27.86																				
Pair Stack: £55.72																				
<b>Wave Roller-Glider Supplement (80mm)</b>	70.71	84.85	99.00	113.14	127.28	141.42	155.56	169.71	183.85	198.19	212.14	226.27	240.41	254.56	268.70	282.85	296.99	311.12	325.27	339.41

For accessories see page 13.

All prices shown exclude VAT





# Pole Systems – Metropole Brackets

## Metropole by Silent Gliss



- 11125 Smart Fix 80mm Bracket (11207 Set)
- 11126 Smart Fix 100mm Bracket (11208 Set)
- 11216 Square Smart Fix 60mm Bracket Set
- 11217 Square Smart Fix 80mm Bracket Set
- 11218 Square Smart Fix 100mm Bracket Set



- 0674 Pillar Bracket
- 0989 Blok Bracket
- 0334 Maxi Adjustable Bracket
- 0335 Top Fix Bracket

## Brackets

Price Category A

Bracket Supplements – Add the following supplement on to the system price if alternative brackets have been specified:

Pole Size (cm)	No. of Brackets	11125 (11207 Set) Smart Fix 80mm		11126 (11208 Set) Smart Fix 100mm		0674 Pillar Bracket			0989 Blok Bracket		0334 Maxi Adjustable Bracket	0335 Top Fix Bracket	
		Colour		Colour		Colour			Colour		Colour	Colour	
		Silver, Black, White, Matt White, Ecu, Gunmetal, Charcoal, Bronze, Antique Bronze, Anodic Grey, Slate Grey, Ochre, Sand, Taupe	Chrome Effect	Silver, Black, White, Matt White, Ecu, Gunmetal, Charcoal, Bronze, Antique Bronze, Anodic Grey, Slate Grey, Ochre, Sand, Taupe	Chrome Effect	Silver, Black, White, Matt White, Ecu	Gunmetal, Charcoal, Bronze, Antique Bronze, Anodic Grey, Slate Grey, Ochre, Sand, Taupe	Chrome Effect	Antique Bronze, Anodic Grey, Black, Bronze, Charcoal, Ecu, Gunmetal, Slate Grey, Silver, Sand, Ochre, Taupe, White, Matt White	Chrome Effect	Silver, Black, Gunmetal, White, Matt White, Charcoal, Ecu, Bronze, Antique Bronze, Anodic Grey, Slate Grey, Ochre, Sand, Taupe	Silver, Black, Gunmetal, White, Matt White, Charcoal, Ecu, Bronze, Antique Bronze, Anodic Grey, Slate Grey, Ochre, Sand, Taupe	Chrome Effect
125	3	£2.77	£1.51	£5.81	£8.53	£17.55	£19.15	£58.15	£83.21	£122.09	£88.44	£37.57	£72.31
150	4	£3.69	£2.02	£7.75	£11.37	£23.40	£25.54	£77.54	£110.95	£162.78	£117.91	£50.10	£96.41
175	4	£3.69	£2.02	£7.75	£11.37	£23.40	£25.54	£77.54	£110.95	£162.78	£117.91	£50.10	£96.41
200	4	£3.69	£2.02	£7.75	£11.37	£23.40	£25.54	£77.54	£110.95	£162.78	£117.91	£50.10	£96.41
225	5	£4.61	£2.52	£9.68	£14.21	£29.25	£31.92	£96.92	£138.69	£203.48	£147.39	£62.62	£120.51
250	5	£4.61	£2.52	£9.68	£14.21	£29.25	£31.92	£96.92	£138.69	£203.48	£147.39	£62.62	£120.51
275	6	£5.54	£3.03	£11.62	£17.06	£35.10	£38.30	£116.31	£166.43	£244.17	£176.87	£75.15	£144.61
300	6	£5.54	£3.03	£11.62	£17.06	£35.10	£38.30	£116.31	£166.43	£244.17	£176.87	£75.15	£144.61
325	6	£5.54	£3.03	£11.62	£17.06	£35.10	£38.30	£116.31	£166.43	£244.17	£176.87	£75.15	£144.61
350	7	£6.46	£3.53	£13.55	£19.90	£40.95	£44.69	£135.69	£194.17	£284.87	£206.35	£87.67	£168.71
375	7	£6.46	£3.53	£13.55	£19.90	£40.95	£44.69	£135.69	£194.17	£284.87	£206.35	£87.67	£168.71
400	7	£6.46	£3.53	£13.55	£19.90	£40.95	£44.69	£135.69	£194.17	£284.87	£206.35	£87.67	£168.71
425	8	£7.38	£4.04	£15.49	£22.74	£46.80	£51.07	£155.08	£221.90	£325.56	£235.83	£100.20	£192.82
450	8	£7.38	£4.04	£15.49	£22.74	£46.80	£51.07	£155.08	£221.90	£325.56	£235.83	£100.20	£192.82
475	9	£8.31	£4.54	£17.43	£25.59	£52.65	£57.46	£174.46	£249.64	£366.26	£265.31	£112.72	£216.92
500	9	£8.31	£4.54	£17.43	£25.59	£52.65	£57.46	£174.46	£249.64	£366.26	£265.31	£112.72	£216.92
525	9	£8.31	£4.54	£17.43	£25.59	£52.65	£57.46	£174.46	£249.64	£366.26	£265.31	£112.72	£216.92
550	10	£9.23	£5.05	£19.36	£28.43	£58.50	£63.84	£193.85	£277.38	£406.95	£294.79	£125.25	£241.02
575	10	£9.23	£5.05	£19.36	£28.43	£58.50	£63.84	£193.85	£277.38	£406.95	£294.79	£125.25	£241.02
600	10	£9.23	£5.05	£19.36	£28.43	£58.50	£63.84	£193.85	£277.38	£406.95	£294.79	£125.25	£241.02

Pole Size (cm)	No. of Brackets	11216 set (11145+11137) Square Smart Fix 60mm			11217 set (11146+11137) Square Smart Fix 80mm			11218 set (11147+11137) Square Smart Fix 100mm		
		Colour			Colour			Colour		
		Silver, White	Black, Matt White, Ecu, Gunmetal, Charcoal, Bronze, Antique Bronze, Anodic Grey, Slate Grey, Ochre, Sand, Taupe	Chrome Effect	Silver, White	Black, Matt White, Ecu, Gunmetal, Charcoal, Bronze, Antique Bronze, Anodic Grey, Slate Grey, Ochre, Sand, Taupe	Chrome Effect	Silver, White	Black, Matt White, Ecu, Gunmetal, Charcoal, Bronze, Antique Bronze, Anodic Grey, Slate Grey, Ochre, Sand, Taupe	Chrome Effect
125	3	£13.57	£17.71	£26.05	£14.92	£19.07	£27.25	£16.84	£20.98	£28.49
150	4	£18.09	£23.61	£34.73	£19.90	£25.42	£36.34	£22.45	£27.97	£37.99
175	4	£18.09	£23.61	£34.73	£19.90	£25.42	£36.34	£22.45	£27.97	£37.99
200	4	£18.09	£23.61	£34.73	£19.90	£25.42	£36.34	£22.45	£27.97	£37.99
225	5	£22.61	£29.51	£43.41	£24.87	£31.78	£45.42	£28.07	£34.97	£47.48
250	5	£22.61	£29.51	£43.41	£24.87	£31.78	£45.42	£28.07	£34.97	£47.48
275	6	£27.13	£35.41	£52.10	£29.85	£38.13	£54.51	£33.68	£41.96	£56.98
300	6	£27.13	£35.41	£52.10	£29.85	£38.13	£54.51	£33.68	£41.96	£56.98
325	6	£27.13	£35.41	£52.10	£29.85	£38.13	£54.51	£33.68	£41.96	£56.98
350	7	£31.65	£41.31	£60.78	£34.82	£44.49	£63.59	£39.29	£48.96	£66.48
375	7	£31.65	£41.31	£60.78	£34.82	£44.49	£63.59	£39.29	£48.96	£66.48
400	7	£31.65	£41.31	£60.78	£34.82	£44.49	£63.59	£39.29	£48.96	£66.48
425	8	£36.17	£47.22	£69.46	£39.80	£50.84	£72.68	£44.91	£55.95	£75.97
450	8	£36.17	£47.22	£69.46	£39.80	£50.84	£72.68	£44.91	£55.95	£75.97
475	9	£40.70	£53.12	£78.15	£44.77	£57.20	£81.76	£50.52	£62.94	£85.47
500	9	£40.70	£53.12	£78.15	£44.77	£57.20	£81.76	£50.52	£62.94	£85.47
525	9	£40.70	£53.12	£78.15	£44.77	£57.20	£81.76	£50.52	£62.94	£85.47
550	10	£45.22	£59.02	£86.83	£49.75	£63.55	£90.85	£56.14	£69.94	£94.97
575	10	£45.22	£59.02	£86.83	£49.75	£63.55	£90.85	£56.14	£69.94	£94.97
600	10	£45.22	£59.02	£86.83	£49.75	£63.55	£90.85	£56.14	£69.94	£94.97

\*Smart Fix bracket sets, 11207 and 11208 are supplied as standard at no additional charge for WAVE. Extension brackets can be coloured to suit Metropole (refer to page 73 for pricing).

All prices shown exclude VAT



# Pole Systems – Metropole

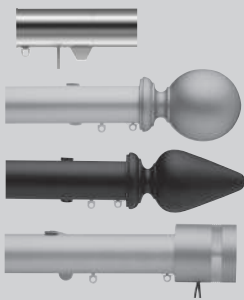

## Metropole by Silent Gliss

A decorative curtain pole concept combining beautifully crafted design details with contemporary finishes on our pole systems 1003/6100/6120/6130/6140 6150 and 6160.

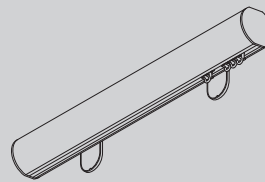

SG 6140 hand operated, Ø 50mm can be bent to a minimum radius of 50cm

Assembled systems below includes 0334 maxi adjustable bracket as standard, including bent poles.

### SG 6140 HAND DRAWN Ø 50mm – SILVER/BLACK/WHITE/MATT WHITE/ECRU

Price Category A

Size (cm)	125	150	175	200	225	250	275	300	325	350	375	400	425	450	475	500	525	550	575	600
Pole 6140 with Flush/Stud endcap																				
Silver/Black/White	197.50	230.36	254.53	278.69	311.56	335.70	368.59	392.74	416.89	449.75	473.90	498.08	530.97	555.10	587.99	612.11	636.28	669.13	693.69	717.46
Pole 6140 inc. finials (2 no. per pole)																				
Spear, Ball End	357.65	390.50	414.68	438.83	471.71	495.84	528.73	552.88	577.04	609.89	634.05	658.22	691.11	715.24	748.13	772.25	796.43	829.27	853.84	877.60
Strata-clear/ribbed disc	340.38	373.24	397.42	421.57	454.45	478.58	511.47	535.62	559.77	592.63	616.78	640.96	673.85	697.98	730.87	754.99	779.16	812.01	836.58	860.34
Strata-coloured disc	362.76	395.61	419.79	443.94	476.82	500.95	533.84	557.99	582.15	615.00	639.16	663.33	696.22	720.35	753.24	777.36	801.54	834.38	858.95	882.71
Groove Cylinder	305.02	337.88	362.06	386.21	419.09	443.22	476.11	500.26	524.41	557.27	581.42	605.60	638.49	662.62	696.54	719.84	743.80	776.65	801.22	824.98
Crystal Cube	374.73	407.59	431.77	455.92	488.80	512.93	545.82	569.97	594.12	626.98	651.14	675.31	708.20	732.33	765.22	789.34	813.51	846.36	870.93	894.89
Crystal Cylinder	366.99	399.85	424.03	448.18	481.06	505.19	538.08	562.24	586.40	619.25	643.40	667.57	700.46	724.59	757.48	781.61	805.78	838.62	863.19	886.95
Fused Barrel - Walnut/Oak/Matched	370.25	403.11	427.29	451.44	484.32	508.45	541.34	565.49	589.64	622.50	646.65	670.83	703.72	727.85	760.74	784.86	809.03	841.88	866.45	890.21
Fused Ball - Walnut/Oak/Matched	369.09	401.95	426.12	450.27	483.15	507.29	540.17	564.33	588.48	621.34	645.49	669.66	702.55	726.69	759.57	783.70	807.87	840.72	865.28	889.04
Clear/Frosted Ball	400.72	433.58	457.75	481.91	514.78	538.92	571.80	595.96	620.11	652.97	677.12	701.30	734.18	758.32	791.20	815.33	839.50	872.35	896.91	920.68

### SG 6140 HAND DRAWN Ø 50mm – TAUPE/ANTIQUÉ BRONZE/ANODIC GREY/SLATE GREY

Size (cm)	125	150	175	200	225	250	275	300	325	350	375	400	425	450	475	500	525	550	575	600
Pole 6140 with Flush/Stud endcap																				
Slate Grey/Taupe/ A. Bronze	282.54	323.17	354.86	386.68	427.22	459.03	499.58	531.39	563.18	603.70	635.51	667.33	707.89	739.72	780.23	812.05	843.83	884.40	916.21	947.99
Pole 6140 inc. finials (2 no. per pole)																				
Spear, Ball End	442.68	483.32	515.00	546.83	587.37	619.17	659.73	691.53	723.33	763.85	795.65	827.47	868.03	899.86	940.37	972.20	1003.97	1044.54	1076.35	1108.16
Strata-clear/ribbed disc	425.42	466.05	497.74	529.56	570.11	601.91	642.46	674.27	706.07	746.59	778.39	810.21	850.77	882.60	923.11	954.93	986.71	1027.28	1059.09	1090.87
Strata-coloured disc	447.79	488.43	520.11	551.94	592.48	624.28	664.83	696.64	728.44	768.96	800.76	832.58	873.14	904.97	945.48	977.41	1009.08	1049.65	1081.46	1113.24
Groove Cylinder	390.06	430.69	462.38	494.20	534.75	566.55	607.10	638.91	670.71	711.23	743.03	774.85	815.41	847.24	887.75	919.57	951.35	991.92	1023.73	1055.51
Crystal Cube	459.77	500.40	532.09	563.91	604.46	636.26	676.81	708.62	740.42	780.94	812.74	844.56	885.12	916.95	957.46	989.28	1021.06	1061.63	1093.44	1125.22
Crystal Cylinder	452.06	492.59	524.37	556.20	596.75	628.56	669.09	700.89	732.69	773.23	805.04	836.86	877.40	909.23	949.75	981.57	1013.36	1053.91	1085.73	1117.50
Fused Barrel - Walnut/Oak/Matched	455.29	495.92	527.61	559.43	599.98	631.78	672.33	704.14	735.94	776.46	808.26	840.08	880.64	912.47	952.98	984.80	1016.58	1057.17	1088.96	1120.74
Fused Ball - Walnut/Oak/Matched	454.13	494.76	526.44	558.27	598.81	630.62	671.17	702.98	734.77	775.29	807.10	838.91	879.48	911.30	951.81	983.64	1015.42	1055.99	1087.79	1119.58
Clear/Frosted Ball	485.76	526.39	558.07	589.90	630.44	662.25	702.80	734.61	766.40	806.92	838.73	870.55	911.11	942.93	983.44	1015.27	1047.05	1087.62	1119.42	1151.21

### 6140 GLIDER – SUPPLEMENTS

Size	125	150	175	200	225	250	275	300	325	350	375	400	425	450	475	500	525	550	575	600
Roller-Glider Supplement	18.54	22.24	25.95	29.66	33.37	37.07	40.78	44.49	48.19	51.90	55.61	59.32	63.02	66.73	70.44	74.14	77.85	81.56	85.27	88.97
Wave® Standard Supplement																				
60mm Glider-cord	19.35	23.21	27.09	30.96	34.82	38.70	42.56	46.44	50.30	54.18	58.05	61.91	65.79	69.65	73.53	77.39	81.26	85.14	89.00	92.88
80mm Glider-cord	15.84	19.19	22.09	24.97	28.33	31.22	34.56	37.46	40.35	43.71	46.59	49.47	52.84	55.72	59.09	61.97	64.87	68.21	71.10	74.00

#### Enhanced Wave Supplement

Please add the following to the above 80mm wave prices.

Option 1: 2255 Adjustable Break	Option 2: 2255 Adjustable Brake & 6366 Carrier	Option 3: Enhanced Wave (80mm only)
Single Stack: £7.39    Pair Stack: £14.79	Single Stack: £15.00    Pair Stack: £30.00	Single Stack: £27.86    Pair Stack: £55.72

Wave Roller-Glider Supplement (80mm)*	70.71	84.85	99.00	113.14	127.28	141.42	155.56	169.71	183.85	198.19	212.14	226.27	240.41	254.56	268.70	282.85	296.99	311.12	325.27	339.41
---------------------------------------	-------	-------	-------	--------	--------	--------	--------	--------	--------	--------	--------	--------	--------	--------	--------	--------	--------	--------	--------	--------

\*Not for use on bent 50mm poles

6140 Connecting Bridge, 0273 see parts list for prices.

Bending (Max. trade discount 33 1/3%) Angle bend: £75.50 each. Semi-circle or gradual curve: £101.00 each. Bent tracks not compatible with 6099

Wave Roller Glider

All prices shown exclude VAT



# Pole Systems – Metropole

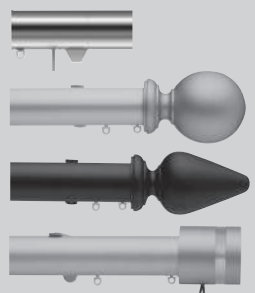

**Metropole** by *Silent Gliss*

A decorative curtain pole concept combining beautifully crafted design details with contemporary finishes on our pole systems 1003/6120/6130 and 6140/6160.

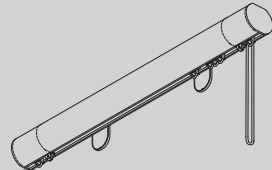

Assembled systems below includes 0334 maxi adjustable bracket as standard, including bent poles.

SG 6160 cord operated, Ø 50mm can be bent to a minimum radius of 60cm

## SG 6160 CORD DRAWN Ø 50mm – BLACK/WHITE/MATT WHITE/ECRU

Size (cm)	125	150	175	200	225	250	275	300	325	350	375	400	425	450	475	500	525	550	575	600	
<b>Pole 6160 with cording set (2 no. flush/stud endcaps)</b>																					
Silver/Black/White	302.46	337.69	364.17	390.66	425.87	452.38	487.58	514.08	540.56	575.78	602.26	628.77	664.00	690.47	725.69	752.19	778.69	813.90	840.38	866.88	
<b>Pole 6160 inc. finials (2 no. per pole)</b>																					
Spear, Ball End	462.60	497.83	524.31	550.80	586.02	612.52	647.73	674.23	700.71	735.92	762.41	788.92	824.14	850.62	885.83	912.33	938.83	974.04	1000.52	1027.02	
Strata-clear/ribbed disc	445.34	480.57	507.05	533.54	568.76	595.26	630.46	656.96	683.45	718.66	745.14	771.66	806.88	833.35	868.57	895.07	921.57	956.78	983.26	1009.76	
Strata-coloured disc	467.71	502.94	529.42	555.91	591.13	617.63	652.83	679.34	705.82	741.03	767.51	794.03	829.25	855.72	890.94	917.44	943.94	979.15	1005.63	1032.13	
Groove Cylinder	409.98	445.21	471.69	498.18	533.40	559.90	595.10	621.61	648.09	683.30	709.78	736.30	771.52	797.99	833.21	859.71	886.21	921.42	947.90	974.40	
Crystal Cube	479.69	514.92	541.40	567.89	603.11	629.61	664.81	691.32	717.80	753.01	779.49	806.01	841.23	867.70	902.92	929.42	955.92	991.13	1017.61	1044.11	
Crystal Cylinder	471.96	507.18	533.66	560.16	595.37	621.87	657.08	683.58	710.06	745.28	771.76	798.27	833.50	859.97	895.18	921.69	948.19	983.39	1009.87	1036.38	
Fused Barrel - Walnut/Oak/Matched	475.21	510.44	536.92	563.41	598.63	625.13	660.33	686.83	713.32	748.53	775.01	801.53	836.75	863.22	898.44	924.94	951.44	986.65	1013.13	1039.63	
Fused Ball - Walnut/Oak/Matched	474.05	509.27	535.75	562.25	597.46	623.96	659.17	685.67	712.15	747.37	773.85	800.36	835.59	862.06	897.27	923.78	950.28	985.48	1011.96	1038.47	
Clear/Frosted Ball	505.68	540.90	567.39	593.88	629.09	655.60	690.80	717.30	743.78	779.00	805.48	831.99	867.22	893.69	928.91	955.41	981.91	1017.11	1043.60	1070.10	

## SG 6160 CORD DRAWN Ø 50mm – TAUPE/ANTIQUE BRONZE/ANODIC GREY/SLATE GREY

Size (cm)	125	150	175	200	225	250	275	300	325	350	375	400	425	450	475	500	525	550	575	600	
<b>Pole 6160 with cording set (2 no. flush/stud endcaps)</b>																					
Slate Grey/Taupe/ A. Bronze	372.85	414.03	446.48	478.97	520.17	552.62	593.82	626.31	658.77	699.94	732.41	764.90	806.07	838.53	879.75	912.21	944.65	985.85	1018.33	1050.80	
<b>Pole 6160 inc. finials (2 no. per pole)</b>																					
Spear, Ball End	532.99	574.17	606.63	639.12	680.32	712.76	753.96	786.46	818.91	860.08	892.56	925.04	966.21	998.68	1040.10	1072.35	1104.80	1146.00	1178.47	1210.94	
Strata-clear/ribbed disc	515.73	556.91	589.37	621.85	663.05	695.50	736.70	769.19	801.65	842.82	875.29	907.78	948.95	981.41	1022.64	1055.09	1087.54	1128.74	1161.21	1193.68	
Strata-coloured disc	538.10	579.28	611.74	644.22	685.42	717.87	759.07	791.57	824.02	865.19	897.67	930.15	971.32	1003.79	1045.01	1077.46	1109.91	1151.11	1183.58	1216.05	
Groove Cylinder	480.37	521.55	554.01	586.49	627.69	660.14	701.34	733.83	766.29	807.46	839.93	872.42	913.59	946.06	987.58	1019.73	1052.18	1093.38	1125.85	1158.32	
Crystal Cube	550.08	591.26	623.72	656.20	697.40	729.85	771.05	803.54	836.00	877.17	909.64	942.13	983.30	1015.77	1056.99	1089.44	1121.89	1163.09	1195.56	1228.03	
Crystal Cylinder	542.35	583.53	615.98	648.47	689.67	722.11	763.31	795.81	828.26	869.43	901.91	934.40	975.56	1008.03	1049.25	1081.71	1114.15	1155.35	1187.83	1220.29	
Fused Barrel - Walnut/Oak/Matched	545.60	586.78	619.24	651.72	692.92	725.37	766.57	799.06	831.52	872.69	905.16	937.65	978.82	1011.28	1052.51	1084.96	1117.41	1158.61	1191.08	1223.55	
Fused Ball - Walnut/Oak/Matched	544.44	585.62	618.07	650.56	691.76	724.20	765.40	797.90	830.36	871.52	904.00	936.49	977.66	1010.12	1051.34	1083.80	1116.24	1157.44	1189.92	1222.38	
Clear/Frosted Ball	576.07	617.25	649.70	682.19	723.39	755.83	797.03	829.53	862.03	895.53	929.03	962.53	1006.03	1049.53	1093.03	1136.53	1180.03	1223.53	1267.03	1310.53	

## 6160 GLIDER – SUPPLEMENTS

Size	125	150	175	200	225	250	275	300	325	350	375	400	425	450	475	500	525	550	575	600	
Roller-Glider Supplement	18.54	22.24	25.95	29.66	33.37	37.07	40.78	44.49	48.19	51.90	55.61	59.32	63.02	66.73	70.44	74.14	77.85	81.56	85.27	88.97	
<b>Wave® Standard Supplement</b>																					
60mm Glider-cord	19.35	23.21	27.09	30.96	34.82	38.70	42.56	46.44	50.30	54.18	58.05	61.91	65.79	69.65	73.53	77.39	81.26	85.14	89.00	92.88	
80mm Glider-cord	15.84	19.19	22.09	24.97	28.33	31.22	34.56	37.46	40.35	43.71	46.59	49.47	52.84	55.72	59.09	61.97	64.87	68.21	71.10	74.00	
<b>Enhanced Wave Supplement</b>																					
Please add the following to the above 80mm wave prices.																					
<b>Enhanced Wave</b>																					
Single Stack: £17.67	Pair Stack: £35.35																				
<b>Wave Roller-Glider Supplement (80mm)*</b>																					
70.71	84.85	99.00	113.14	127.28	141.42	155.56	169.71	183.85	198.19	212.14	226.27	240.41	254.56	268.70	282.85	296.99	311.12	325.27	339.41		

\*Not for use on bent 50mm poles

Child safety device (10483) – add on £9.53. Note: Only applicable for complete systems with curtains by Silent Gliss. 6160 Intermediate Pulley 20646, see parts list for prices.  
 Bending (Max. trade discount 33¼%) Angle bend: £73.50 each. Semi-circle or gradual curve: £101.00 each. Bent tracks not compatible with 6099  
 Wave Roller Glider All prices shown exclude VAT



# Pole Systems – Metropole

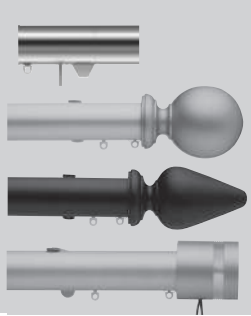

## Metropole by Silent Gliss

A decorative curtain pole concept combining beautifully crafted design details with contemporary finishes on our pole systems 1003/6120/6130 and 6140/6150/6160.

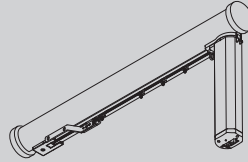

SG 6150 electrically operated, Ø 50mm straight only.

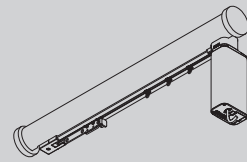

All assembled systems below includes 0334 maxi adjustable bracket as standard.

### Electric Metropole SG 6150 System – 5100 B Version

### Price Category A

Size (cm)	125	150	175	200	225	250	275	300	325	350	375	400	425	450	475	500
<b>Pole 6150 with Flush/Stud endcaps</b>																
Ecu/Silver/White/Black/Matt White	851.41	876.14	920.39	937.49	1054.60	1071.69	1115.84	1132.93	1250.03	1274.80	1311.27	1336.04	1445.48	1470.25	1514.40	1531.50
<b>Pole 6150 inc. finials (2 no. per pole)</b>																
Spear Ball end	1011.55	1036.29	1080.53	1097.63	1214.74	1231.84	1275.98	1293.08	1410.18	1434.94	1471.42	1496.18	1605.63	1630.39	1674.54	1691.64
Strata - clear/ribbed disc	994.29	1019.03	1063.27	1080.37	1197.48	1214.58	1258.72	1275.82	1392.92	1417.68	1454.15	1478.92	1588.36	1613.13	1657.28	1674.38
Strata - coloured disc	1016.66	1041.40	1085.64	1102.74	1219.85	1236.95	1281.09	1298.19	1415.29	1440.05	1476.53	1501.29	1610.74	1635.50	1679.65	1696.75
Groove Cylinder	958.93	983.67	1027.91	1045.01	1162.12	1179.22	1223.36	1240.46	1357.56	1382.32	1418.80	1443.56	1553.00	1577.77	1621.92	1639.02
Crystal Cylinder	1028.64	1053.38	1097.62	1114.72	1231.83	1248.93	1293.07	1310.17	1427.27	1452.03	1488.51	1513.27	1622.71	1647.48	1691.63	1708.73
Crystal Cube	1020.91	1045.64	1089.88	1106.98	1224.09	1241.19	1285.33	1302.43	1419.53	1444.30	1480.77	1505.54	1614.98	1639.75	1683.90	1701.00
Fused Barrel - Walnut/Oak/Matched	1024.16	1048.90	1093.14	1110.24	1227.35	1244.45	1288.59	1305.69	1422.79	1447.55	1484.02	1508.79	1618.23	1643.00	1687.15	1704.25
Fused Ball - Walnut/Oak/Matched	1023.00	1047.73	1091.97	1109.07	1226.18	1243.28	1287.42	1304.52	1421.62	1446.39	1482.86	1507.63	1617.07	1641.84	1685.99	1703.09
Clear/Frosted Ball	1054.63	1079.36	1123.61	1140.70	1257.81	1274.91	1319.05	1336.15	1453.25	1478.02	1514.49	1539.26	1648.70	1673.47	1717.62	1734.72
<b>Pole 6150 with Flush/Stud endcaps</b>																
Anodic Grey/Slate Grey/Antique Bronze/Taupe	887.37	915.95	964.05	985.00	1105.92	1126.89	1174.87	1195.82	1316.78	1345.40	1385.70	1414.34	1527.62	1556.21	1604.22	1625.18
<b>Pole 6150 inc. finials (2 no. per pole)</b>																
Spear Ball end	1047.52	1076.09	1124.19	1145.14	1266.07	1287.04	1335.02	1355.97	1476.93	1505.54	1545.84	1574.48	1687.76	1716.36	1764.37	1785.33
Strata - clear/ribbed disc	1030.26	1058.83	1106.93	1127.88	1248.81	1269.78	1317.76	1338.70	1459.66	1488.28	1528.58	1557.22	1670.50	1699.09	1747.11	1768.07
Strata - coloured disc	1052.63	1081.20	1129.30	1150.25	1271.18	1292.15	1340.13	1361.08	1482.04	1510.65	1550.95	1579.59	1692.87	1721.46	1769.48	1790.44
Groove Cylinder	994.90	1023.47	1071.57	1092.52	1213.45	1234.42	1282.40	1303.34	1424.30	1452.92	1493.22	1521.86	1635.14	1663.73	1711.75	1732.71
Crystal Cylinder	1064.61	1093.18	1141.28	1162.23	1283.16	1304.13	1352.11	1373.05	1494.01	1522.63	1562.93	1591.57	1704.85	1733.44	1781.46	1802.42
Crystal Cube	1056.87	1085.44	1133.55	1154.49	1275.42	1296.39	1344.37	1365.32	1486.28	1514.90	1555.20	1583.83	1697.11	1725.71	1773.72	1794.68
Fused Barrel - Walnut/Oak/Matched	1060.13	1088.70	1136.80	1157.75	1278.68	1299.65	1347.63	1368.57	1489.53	1518.15	1558.45	1587.09	1700.37	1728.96	1776.98	1797.94
Fused Ball - Walnut/Oak/Matched	1058.96	1087.53	1135.64	1156.59	1277.51	1298.48	1346.46	1367.41	1488.37	1516.99	1557.29	1585.93	1699.21	1727.80	1775.81	1796.77
Clear/Frosted Ball	1090.59	1119.16	1167.27	1188.22	1309.14	1330.11	1378.09	1399.04	1520.00	1548.62	1588.92	1617.56	1730.84	1759.43	1807.44	1828.40

### Electric Metropole SG 6150 System – 5100 R Version

Size (cm)	125	150	175	200	225	250	275	300	325	350	375	400	425	450	475	500
<b>Pole 6150 with Flush/Stud endcaps</b>																
Ecu/Silver/White/Black/Matt White	911.29	936.02	980.19	997.29	1114.40	1131.49	1175.64	1192.73	1309.83	1334.60	1371.07	1395.84	1505.36	1530.13	1574.28	1591.38
<b>Pole 6150 inc. finials (2 no. per pole)</b>																
Spear Ball end	1071.43	1096.17	1140.33	1157.43	1274.54	1291.64	1335.78	1352.88	1469.98	1494.74	1531.22	1555.98	1665.51	1690.27	1734.42	1751.52
Strata - clear/ribbed disc	1054.17	1078.91	1123.07	1140.17	1257.28	1274.38	1318.52	1335.62	1452.71	1477.48	1513.95	1538.72	1648.24	1673.01	1717.16	1734.26
Strata - coloured disc	1076.54	1101.28	1145.44	1162.54	1279.65	1296.75	1340.89	1357.99	1475.09	1499.85	1536.33	1561.09	1670.62	1695.38	1739.53	1756.63
Groove Cylinder	1018.81	1043.55	1087.71	1104.81	1221.92	1239.02	1283.16	1300.26	1417.35	1442.12	1478.59	1503.36	1612.88	1637.65	1681.80	1698.90
Crystal Cylinder	1088.52	1113.26	1157.42	1174.52	1291.63	1308.73	1352.87	1369.97	1487.07	1511.83	1548.30	1573.07	1682.59	1707.36	1751.51	1768.61
Crystal Cube	1080.79	1105.52	1149.68	1166.78	1283.89	1300.99	1345.13	1362.23	1479.33	1504.10	1540.57	1565.34	1674.86	1699.63	1743.78	1760.88
Fused Barrel - Walnut/Oak/Matched	1084.04	1108.78	1152.94	1170.04	1287.15	1304.25	1348.39	1365.49	1482.58	1507.35	1543.82	1568.59	1678.11	1702.88	1747.03	1764.13
Fused Ball - Walnut/Oak/Matched	1082.88	1107.61	1151.77	1168.87	1285.98	1303.08	1347.22	1364.32	1481.42	1506.19	1542.66	1567.43	1676.95	1701.72	1745.87	1762.97
Clear/Frosted Ball	1114.51	1139.24	1183.41	1200.50	1317.61	1334.71	1378.85	1395.95	1513.05	1537.82	1574.29	1599.06	1708.58	1733.35	1777.50	1794.60
<b>Pole 6150 with Flush/Stud endcaps</b>																
Anodic Grey/Slate Grey/Antique Bronze/Taupe	947.25	975.83	1023.85	1044.80	1165.72	1186.69	1234.67	1255.62	1376.58	1405.20	1445.50	1474.14	1587.50	1616.09	1664.10	1685.06
<b>Pole 6150 inc. finials (2 no. per pole)</b>																
Spear Ball end	1107.40	1135.97	1183.99	1204.94	1325.87	1346.84	1394.82	1415.77	1536.73	1565.34	1605.64	1634.28	1747.64	1776.24	1824.25	1845.21
Strata - clear/ribbed disc	1090.14	1118.71	1166.73	1187.68	1308.60	1329.58	1377.56	1398.50	1519.46	1548.08	1588.38	1617.02	1730.38	1759.97	1808.99	1827.95
Strata - coloured disc	1112.51	1141.08	1189.10	1210.05	1330.98	1351.95	1399.93	1420.88	1541.84	1570.45	1610.75	1639.39	1752.75	1781.34	1829.36	1850.32
Groove Cylinder	1054.78	1083.35	1131.37	1152.32	1273.25	1294.22	1342.20	1363.14	1484.10	1512.72	1553.02	1581.66	1695.02	1723.61	1771.63	1792.59
Crystal Cylinder	1124.49	1153.06	1201.08	1222.03	1342.96	1363.93	1411.91	1432.85	1553.81	1582.43	1622.73	1651.37	1764.73	1793.32	1841.34	1862.30
Crystal Cube	1116.75	1145.32	1193.35	1214.29	1335.22	1356.19	1404.17	1425.12	1546.08	1574.69	1615.00	1643.63	1756.99	1785.59	1833.60	1854.56
Fused Barrel - Walnut/Oak/Matched	1120.01	1148.58	1196.60	1217.55	1338.47	1359.45	1407.43	1428.37	1549.33	1577.95	1618.25	1646.89	1760.25	1788.84	1836.86	1857.82
Fused Ball - Walnut/Oak/Matched	1118.84	1147.41	1195.44	1216.39	1337.31	1358.28	1406.26	1427.21	1548.17	1576.79	1617.09	1645.72	1759.09	1787.68	1835.69	1856.65
Clear/Frosted Ball	1150.47	1179.04	1227.07	1248.02	1368.94	1389.91	1437.89	1458.84	1579.80	1608.42	1648.72	1677.36	1790.72	1819.31	1867.32	1888.28

### Electric Metropole SG 6150 System – 5100 T Version

Size (cm)	125	150	175	200	225	250	275	300	325	350	375	400	425	450	475	500
<b>Pole 6150 with Flush/Stud endcaps</b>																
Ecu/Silver/White/Black/Matt White	996.28	1021.01	1065.18	1082.28	1199.39	1216.48	1260.63	1277.72	1394.82	1419.59	1456.06	1480.83	1590.27	1615.04	1659.19	1676.29
<b>Pole 6150 inc. finials (2 no. per pole)</b>																
Spear Ball end	1156.43	1181.16	1225.32	1242.42	1359.53	1376.63	1420.77	1437.87	1554.97	1579.73	1616.21	1640.97	1750.42	1775.18	1819.34	1836.43
Strata - clear/ribbed disc	1139.16	1163.90	1208.06	1225.16	1342.27	1359.37	1403.51	1420.61	1537.71	1562.47	1598.95	1623.71	1733.15	1757.92	1802.07	1819.17
Strata - coloured disc	1161.53	1186.27	1230.43	1247.53	1364.64	1381.74	1425.88	1442.98	1560.08	1584.84	1621.32	1646.08	1755.53	1780.29	1824.44	1841.54
Groove Cylinder	1103.80	1128.54	1172.70	1189.80	1306.91	1324.01	1368.15	1385.25	1502.35							



# Pole Systems – Metropole

## Electric Metropole SG 6150 System – 5100 TC Version

### Price Category A

Size	125	150	175	200	225	250	275	300	325	350	375	400	425	450	475	500
<b>Pole 6150 with standard endcaps</b>																
Ecu/Silver/White/Black/Matt White	1056.16	1080.89	1125.06	1142.16	1259.27	1276.36	1320.51	1337.60	1454.70	1479.47	1515.94	1540.71	1650.15	1674.92	1719.07	1736.17
<b>Pole 6150 inc. finials (2 no. per pole)</b>																
Spear, Ball end	1216.31	1241.04	1285.20	1302.30	1419.41	1436.51	1480.65	1497.75	1614.85	1639.61	1676.09	1700.85	1810.30	1835.06	1879.22	1896.31
Strata - clear/ribbed disc	1199.04	1223.78	1267.94	1285.04	1402.15	1419.25	1463.39	1480.49	1597.59	1622.35	1658.83	1683.59	1793.03	1817.80	1861.95	1879.05
Strata - coloured disc	1221.41	1246.15	1290.31	1307.41	1424.52	1441.62	1485.76	1502.86	1619.96	1644.72	1681.20	1705.96	1815.41	1840.17	1884.32	1901.42
Groove Cylinder	1163.68	1188.42	1232.58	1249.68	1366.79	1383.89	1428.03	1445.13	1562.23	1586.99	1623.47	1648.23	1757.67	1782.44	1826.59	1843.69
Crystal Cylinder	1233.39	1258.13	1302.29	1319.39	1436.50	1453.60	1497.74	1514.84	1631.94	1656.70	1693.18	1717.94	1827.38	1852.15	1896.30	1913.40
Crystal Cube	1225.66	1250.39	1294.55	1311.65	1428.76	1445.86	1490.00	1507.10	1624.20	1648.97	1685.44	1710.21	1819.65	1844.42	1888.57	1905.67
Fused Barrel - Walnut/Oak/Matched	1228.91	1253.65	1297.81	1314.91	1432.02	1449.12	1493.26	1510.36	1627.46	1652.22	1688.70	1713.46	1822.90	1847.67	1891.82	1908.92
Fused Ball - Walnut/Oak/Matched	1227.75	1252.48	1296.65	1313.74	1430.85	1447.95	1492.09	1509.19	1626.29	1651.06	1687.53	1712.30	1821.74	1846.51	1890.66	1907.76
Clear/Frosted Ball	1259.38	1284.11	1328.28	1345.38	1462.49	1479.58	1523.73	1540.82	1657.92	1682.69	1719.16	1743.93	1853.37	1878.14	1922.29	1939.39
<b>Pole 6150 with standard endcaps</b>																
Anodic Grey/Slate Grey/Antique Bronze/Taupe	1092.12	1120.70	1168.72	1189.67	1310.59	1331.57	1379.54	1400.49	1521.45	1550.07	1590.37	1619.01	1732.29	1760.88	1808.89	1829.85
<b>Pole 6150 inc. finials (2 no. per pole)</b>																
Spear, Ball end	1252.27	1280.84	1328.86	1349.81	1470.74	1491.71	1539.69	1560.64	1681.60	1710.21	1750.51	1779.15	1892.43	1921.03	1969.04	1990.00
Strata - clear/ribbed disc	1235.01	1263.58	1311.60	1332.55	1453.48	1474.45	1522.43	1543.37	1664.33	1692.95	1733.25	1761.89	1875.17	1903.76	1951.78	1972.74
Strata - coloured disc	1257.38	1285.95	1333.97	1354.92	1475.85	1496.82	1544.80	1565.75	1686.71	1715.32	1755.62	1784.26	1897.54	1926.14	1974.15	1995.11
Groove Cylinder	1199.65	1228.22	1276.24	1297.19	1418.12	1439.09	1487.07	1508.01	1628.97	1657.59	1697.89	1726.53	1839.81	1868.40	1916.42	1937.38
Crystal Cylinder	1269.36	1297.93	1345.95	1366.90	1487.83	1508.80	1556.78	1577.72	1698.69	1727.30	1767.60	1796.24	1909.52	1938.11	1986.13	2007.09
Crystal Cube	1261.62	1290.19	1338.22	1359.17	1480.09	1501.06	1549.04	1569.99	1690.95	1719.57	1759.87	1788.50	1901.79	1930.38	1978.39	1999.35
Fused Barrel - Walnut/Oak/Matched	1264.88	1293.45	1341.47	1362.42	1483.35	1504.32	1552.30	1573.24	1694.20	1722.82	1763.12	1791.76	1905.04	1933.63	1981.65	2002.61
Fused Ball - Walnut/Oak/Matched	1263.71	1292.28	1340.31	1361.26	1482.18	1503.15	1551.13	1572.08	1693.04	1721.66	1761.96	1790.60	1903.88	1932.47	1980.48	2001.44
Clear/Frosted Ball	1295.34	1323.92	1371.94	1392.89	1513.81	1534.78	1582.76	1603.71	1724.67	1753.29	1793.59	1822.23	1935.51	1964.10	2012.11	2033.07

## 6150 WAVE – SUPPLEMENTS (applicable to 5100 versions only)

Size	125	150	175	200	225	250	275	300	325	350	375	400	425	450	475	500
<b>Wave® Standard Supplement</b>																
60mm Glider-Cord	39.39	47.26	55.15	63.02	70.90	78.78	86.65	94.52	102.41	110.29	118.18	126.05	133.93	141.81	149.69	157.56
80mm Glider-Cord	33.71	40.45	47.19	53.92	60.67	67.41	74.16	80.90	87.64	94.38	101.13	107.87	114.62	121.36	128.10	134.84

## Electric Metropole SG 6150 System – 5600 Version

### Price Category C

Size (cm)	125	150	175	200	225	250	275	300	325	350	375	400	425	450	475	500	525	550	575	600	
<b>Pole 6150 with Flush/Stud endcaps</b>																					
Ecu/Silver/White/Black/Matt White	1610.19	1630.83	1679.31	1692.29	1813.67	1826.64	1875.06	1888.04	2009.45	2030.11	2070.86	2091.50	2205.23	2225.87	2274.32	2287.28	2408.68	2421.65	2470.45	2490.76	
<b>Pole 6150 inc. finials (2 no. per pole)</b>																					
Spear, Ball end	1770.33	1790.97	1839.46	1852.44	1973.82	1986.79	2035.21	2048.19	2169.59	2190.26	2231.01	2251.65	2365.38	2386.02	2434.46	2447.42	2568.82	2581.79	2630.60	2650.90	
Strata - clear/ribbed disc	1753.07	1773.71	1822.20	1835.18	1956.55	1969.52	2017.94	2030.93	2152.33	2172.99	2213.74	2234.38	2348.11	2368.75	2417.20	2430.16	2551.56	2564.53	2613.33	2633.64	
Strata - coloured disc	1775.44	1796.08	1844.57	1857.55	1978.93	1991.89	2040.32	2053.30	2174.70	2195.36	2236.12	2256.76	2370.49	2391.13	2439.57	2452.53	2573.93	2586.90	2635.70	2656.01	
Groove Cylinder	1717.71	1738.35	1786.84	1799.82	1921.19	1934.16	1982.58	1995.57	2116.97	2137.63	2178.38	2199.02	2312.75	2333.39	2381.84	2394.80	2516.20	2529.17	2577.97	2598.28	
Crystal Cylinder	1787.42	1808.06	1856.55	1869.53	1990.90	2003.87	2052.30	2065.28	2186.68	2207.34	2248.09	2268.73	2382.46	2403.10	2451.55	2464.51	2585.91	2598.88	2647.68	2667.99	
Crystal Cube	1779.69	1800.33	1848.81	1861.79	1983.17	1996.14	2044.56	2057.54	2178.94	2199.61	2240.36	2261.00	2374.73	2395.37	2443.82	2456.77	2578.18	2591.14	2639.95	2660.25	
Fused Barrel - Walnut/Oak/Matched	1782.94	1803.58	1852.07	1865.05	1986.42	1999.39	2047.81	2060.80	2182.20	2202.86	2243.61	2264.25	2377.98	2398.62	2447.07	2460.03	2581.43	2594.40	2643.20	2663.51	
Fused Ball - Walnut/Oak/Matched	1781.78	1802.42	1850.90	1863.88	1985.26	1998.23	2046.65	2059.63	2181.03	2201.70	2242.45	2263.09	2376.82	2397.46	2445.91	2458.86	2580.27	2593.23	2642.04	2662.35	
Clear/Frosted Ball	1813.41	1834.05	1882.53	1895.51	2016.89	2029.86	2078.28	2091.26	2212.67	2233.33	2274.08	2294.72	2408.45	2429.09	2477.54	2490.49	2611.90	2624.87	2673.67	2693.98	
<b>Pole 6150 with Flush/Stud endcaps</b>																					
Anodic Grey/Slate Grey/Antique Bronze/Taupe	1646.14	1670.62	1722.94	1739.77	1865.02	1881.83	1934.09	1950.94	2076.18	2100.69	2145.27	2169.77	2287.36	2311.86	2364.13	2380.92	2506.19	2523.01	2575.66	2599.81	
<b>Pole 6150 inc. finials (2 no. per pole)</b>																					
Spear, Ball end	1806.28	1830.77	1883.08	1899.91	2025.16	2041.98	2094.23	2111.08	2236.32	2260.83	2305.42	2329.92	2447.50	2472.00	2524.27	2541.06	2666.34	2683.15	2735.80	2759.95	
Strata - clear/ribbed disc	1789.02	1813.50	1865.82	1882.65	2007.90	2024.71	2076.97	2093.82	2219.06	2243.57	2288.15	2312.65	2430.24	2454.74	2507.01	2523.80	2649.07	2665.89	2718.54	2742.69	
Strata - coloured disc	1811.39	1835.88	1888.19	1905.02	2030.27	2047.08	2099.34	2116.19	2241.43	2265.94	2310.52	2335.02	2452.61	2477.11	2529.38	2546.17	2671.44	2688.26	2740.91	2765.06	
Groove Cylinder	1753.66	1778.14	1830.46	1847.29	1972.54	1989.35	2041.61	2058.46	2183.70	2208.21	2252.79	2277.29	2394.88	2419.38	2471.65	2488.44	2613.71	2630.53	2683.18	2707.33	
Crystal Cylinder	1823.37	1847.85	1900.17	1917.00	2042.25	2059.06	2111.32	2128.17	2253.41	2277.92	2322.50	2347.00	2464.59	2489.09	2541.36	2558.15	2683.42	2700.24	2752.89	2777.04	
Crystal Cube	1815.63	1840.12	1892.44	1909.26	2034.51	2051.33	2103.58	2120.44	2245.67	2270.18	2314.77	2339.27	2456.86	2481.36	2533.62	2550.41	2675.69	2692.50	2745.15	2769.31	
Fused Barrel - Walnut/Oak/Matched	1818.89	1843.37	1895.69	1912.52	2037.77	2054.58	2106.84	2123.69	2248.93	2273.44	2318.02	2342.52	2460.11	2484.61	2536.88	2553.67	2678.94	2695.76	2748.41	2772.56	
Fused Ball - Walnut/Oak/Matched	1817.72	1842.21	1894.53	1911.35	2036.60	2053.42	2105.67	2122.53	2247.76	2272.27	2316.86	2341.36	2458.95	2483.45	2535.72	2552.51	2677.78	2694.59	2747.25	2771.40	
Clear/Frosted Ball	1849.36	1873.84	1926.16	1942.99	2068.23	2085.05	2137.31	2154.16	2279.40	2303.91	2348.49	2372.99	2490.58	2515.08	2567.35	2584.14	2709.41	2726.23	2778.88	2803.03	

## SMART by Silent Gliss – For SG 6150/5600 control via third party control system

### Price Category C

Electric Track	SG 5600
11270 Plug in RS 485 motor module	Add £195.00 per system
**Power supplies not included - see separate associated components prices page 28.	

## Wave Roller Glider – SUPPLEMENT

Size (cm)	125	150	175	200	225	250	275	300	325	350	375	400	425	450	475	500	525	550	575	600
60/80mm	41.89	50.																		





# Pole Systems – Metropole

## Electric Metropole SG 6150 System – 5600 Integral Receiver System

Price Category C

Size (cm)	125	150	175	200	225	250	275	300	325	350	375	400	425	450	475	500	525	550	575	600
<b>Pole 6150 with Flush/Stud endcaps</b>																				
<b>Eccru/Silver/White/Black/Matt White</b>																				
	1786.58	1807.22	1855.70	1868.68	1990.06	2003.03	2051.45	2064.43	2185.83	2206.50	2247.25	2267.89	2381.62	2402.26	2450.71	2463.66	2585.07	2598.03	2646.84	2667.15
<b>Pole 6150 inc. finials (2 no. per pole)</b>																				
Spear, Ball end	1946.72	1967.36	2015.85	2028.83	2150.20	2163.17	2211.59	2224.58	2345.98	2366.64	2407.39	2428.03	2541.76	2562.40	2610.85	2623.81	2745.21	2758.18	2806.98	2827.29
Strata - clear/ribbed disc	1929.46	1950.10	1998.58	2011.56	2132.94	2145.91	2194.33	2207.31	2328.72	2349.38	2390.13	2410.77	2524.50	2545.14	2593.59	2606.55	2727.95	2740.92	2789.72	2810.03
Strata - coloured disc	1951.83	1972.47	2020.95	2033.94	2155.31	2168.28	2216.70	2229.68	2351.09	2371.75	2412.50	2433.14	2546.87	2567.51	2615.96	2628.92	2750.32	2763.29	2812.09	2832.40
Groove Cylinder	1894.10	1914.74	1963.22	1976.20	2097.58	2110.55	2158.97	2171.95	2293.36	2314.02	2354.77	2375.41	2489.14	2509.78	2558.23	2571.19	2692.59	2705.56	2754.36	2774.67
Crystal Cylinder	1963.81	1984.45	2032.93	2045.91	2167.29	2180.26	2228.68	2241.66	2363.07	2383.73	2424.48	2445.12	2558.85	2579.49	2627.94	2640.90	2762.30	2775.27	2824.07	2844.38
Crystal Cube	1956.07	1976.71	2025.20	2038.18	2159.56	2172.53	2220.95	2233.93	2355.33	2376.00	2416.75	2437.39	2551.12	2571.76	2620.20	2633.16	2754.56	2767.53	2816.34	2836.64
Fused Barrel - Walnut/Oak/Matched	1959.33	1979.97	2028.45	2041.43	2162.81	2175.78	2224.20	2237.18	2358.59	2379.25	2420.00	2440.64	2554.37	2575.01	2623.46	2636.42	2757.82	2770.79	2819.59	2839.90
Fused Ball - Walnut/Oak/Matched	1958.16	1978.81	2027.29	2040.27	2161.65	2174.62	2223.04	2236.02	2357.42	2378.09	2418.84	2439.48	2553.21	2573.85	2622.29	2635.25	2756.65	2769.62	2818.43	2838.73
Clear/Frosted Ball	1989.80	2010.44	2058.92	2071.90	2193.28	2206.25	2254.67	2267.65	2389.05	2409.72	2450.47	2471.11	2584.84	2605.48	2653.93	2666.88	2788.28	2801.25	2850.06	2870.36
<b>Pole 6150 with Flush/Stud endcaps</b>																				
<b>Anodic Grey/Slate Grey/Antique Bronze/Taupe</b>																				
	1822.52	1847.01	1899.33	1916.15	2041.40	2058.22	2110.47	2127.33	2252.56	2277.07	2321.66	2346.16	2463.75	2488.25	2540.51	2557.31	2682.58	2699.39	2752.05	2776.20
<b>Pole 6150 inc. finials (2 no. per pole)</b>																				
Spear, Ball end	1982.67	2007.15	2059.47	2076.30	2201.55	2218.36	2270.62	2287.47	2412.71	2437.22	2481.80	2506.30	2623.89	2648.39	2700.66	2717.45	2842.72	2859.54	2912.19	2936.34
Strata - clear/ribbed disc	1965.41	1989.89	2042.21	2059.04	2184.29	2201.10	2253.36	2270.21	2395.45	2419.96	2464.54	2489.04	2606.63	2631.13	2683.40	2700.19	2825.46	2842.28	2894.93	2919.08
Strata - coloured disc	1987.78	2012.26	2064.58	2081.41	2206.66	2223.47	2275.73	2292.58	2417.82	2442.33	2486.91	2511.41	2629.00	2653.50	2705.77	2722.56	2847.83	2864.65	2917.30	2941.45
Groove Cylinder	1930.05	1954.53	2006.85	2023.68	2148.93	2165.74	2218.00	2234.85	2360.09	2384.60	2429.18	2453.68	2571.27	2595.77	2648.04	2664.83	2790.10	2806.92	2859.57	2883.72
Crystal Cylinder	1999.76	2024.24	2076.56	2093.39	2218.64	2235.45	2287.71	2304.56	2429.80	2454.31	2498.89	2523.39	2640.98	2665.48	2717.75	2734.54	2859.81	2876.63	2929.28	2953.43
Crystal Cube	1992.02	2016.51	2068.82	2085.65	2210.90	2227.72	2279.97	2296.82	2422.06	2446.57	2491.16	2515.65	2633.24	2657.74	2710.01	2726.80	2852.08	2868.89	2921.54	2945.69
Fused Barrel - Walnut/Oak/Matched	1995.28	2019.76	2072.08	2088.91	2214.16	2230.97	2283.23	2300.08	2425.32	2449.83	2494.41	2518.91	2636.50	2661.00	2713.27	2730.06	2855.33	2872.15	2924.80	2948.95
Fused Ball - Walnut/Oak/Matched	1994.11	2018.60	2070.92	2087.74	2212.99	2229.81	2282.06	2298.91	2424.15	2448.66	2493.25	2517.75	2635.34	2659.83	2712.10	2728.89	2854.17	2870.98	2923.63	2947.79
Clear/Frosted Ball	2025.74	2050.23	2102.55	2119.37	2244.62	2261.44	2313.69	2330.55	2455.78	2480.29	2524.88	2549.38	2666.97	2691.47	2743.73	2760.52	2885.80	2902.61	2955.26	2979.42

## Wave Roller Glider – SUPPLEMENT

Size (cm)	125	150	175	200	225	250	275	300	325	350	375	400	425	450	475	500	525	550	575	600
60/80mm	41.89	50.26	58.63	67.00	75.37	83.75	92.12	100.50	108.87	117.25	125.62	134.00	142.37	150.75	159.12	167.49	175.86	184.24	192.62	201.00

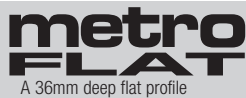

Assembled systems below includes Smart Fix Set 11206 as standard.  
Bent poles are supplied with Smart Fix Set 11209 as standard.  
For additional bracket options, please see page 13.

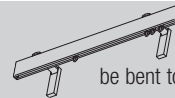

System 6100 is hand operated only and can be bent to a minimum radius of 20cm.

## SG 6100M HAND DRAWN 36mm deep – WHITE/SILVER/BLACK/GUNMETAL/ANTIQU BRONZE/CHROME (max. length 3.95m)/ ANODIC GREY/CHARCOAL/SLATE GREY/MATT WHITE

Price Category A

Size	125	150	175	200	225	250	275	300	325	350	375	400	425	450	475	500	525	550	575	600						
<b>Pole 6100 with Flush/Stud endcaps</b>																										
<b>Silver/Black/White/Matt White</b>																										
Shard - Clear	100.88	114.27	127.76	141.22	154.61	168.10	181.52	195.02	208.41	221.87	235.33	248.78	262.24	275.68	289.13	302.57	316.00	329.45	342.89	356.33						
Shard - Etched	173.18	186.57	200.07	213.53	226.92	240.40	253.82	267.33	280.72	294.18	307.64	321.08	334.54	347.99	361.44	374.88	388.31	401.75	415.19	428.63						
Fused Barrel - Walnut/Oak/Colour Matched	189.87	203.26	216.75	230.22	243.61	257.09	270.51	284.01	297.40	310.86	324.33	337.77	351.23	364.67	378.12	391.56	405.00	418.44	431.88	445.22						
Fused Ball - Walnut/Oak/Colour Matched	198.63	212.02	225.51	238.97	252.36	265.84	279.26	292.77	306.16	319.62	333.08	346.52	359.99	373.43	386.88	400.32	413.75	427.19	440.63	454.08						
Fused Ball - Walnut/Oak/Colour Matched	205.44	218.83	232.33	245.99	259.18	272.66	286.08	299.59	312.98	326.44	339.90	353.34	366.80	380.25	393.70	407.14	420.57	434.01	447.45	460.89						
<b>Pole 6100 with Flush/Stud endcaps</b>																										
<b>Slate Grey/Charcoal/Chrome/Anodic Grey/Ant Bze Gunmetal</b>																										
Shard - Clear	121.17	138.68	156.19	173.71	191.22	208.71	226.23	243.72	261.25	278.74	296.25	313.72	331.28	348.79	366.29	383.77	401.29	418.80	436.31	453.82						
Shard - Etched	193.48	210.99	228.50	246.02	263.53	281.01	298.54	316.02	333.56	351.04	368.55	386.02	403.58	421.09	438.59	456.07	473.59	491.10	508.61	526.12						
Fused Barrel - Walnut/Oak/Colour Matched	210.16	227.67	245.18	262.70	280.21	297.70	315.22	332.71	350.24	367.73	385.24	402.71	420.27	437.78	455.28	472.76	490.28	507.79	525.30	542.81						
Fused Ball - Walnut/Oak/Colour Matched	218.92	236.43	253.94	271.46	288.97	306.46	323.98	341.47	359.00	376.49	394.00	411.46	429.02	446.54	464.04	481.51	499.04	516.55	534.06	551.57						
Fused Ball - Walnut/Oak/Colour Matched	225.73	243.24	260.75	278.28	295.79	313.27	330.79	348.28	365.81	383.30	400.81	418.28	435.84	453.35	470.85	488.33	505.85	523.36	540.87	558.38						
Roller-Glider Supplement	18.54	22.24	25.95	29.66	33.37	37.07	40.78	44.49	48.19	51.90	55.61	59.32	63.02	66.73	70.44	74.14	77.85	81.56	85.27	88.97						
<b>Wave™ Standard Supplement</b>																										
60mm Glider-cord	19.35	23.21	27.09	30.96	34.82	38.70	42.56	46.44	50.30	54.18	58.05	61.91	65.79	69.65	73.53	77.39	81.26	85.14	89.00	92.88						
80mm Glider-cord	15.84	19.19	22.09	24.97	28.33	31.22	34.56	37.46	40.35	43.71	46.59	49.47	52.84	55.72	59.09	61.97	64.87	68.21	71.10	74.00						
<b>OR</b>																										
<b>Enhanced Wave Supplement (with added optional extras)</b>																										
Please add the following to the above 80mm wave prices.																										
Option 1: 2255 Adjustable Break	Option 2: 2255 Adjustable Brake & 6366 Carrier					Option 3: Enhanced Wave (80mm only)																				
Single Stack: £7.39	Pair Stack: £14.79					Single Stack: £15.00					Pair Stack: £30.00					Single Stack: £27.86						Pair Stack: £55.72				
Wave Roller-Glider Supplement (80mm)	70.71	84.85	99.00	113.14	127.28	141.42	155.56	169.71	183.85	198.19	212.14	226.27	240.41	254.56	268.70	282.85	296.99	311.12	325.27	339.41						

Bending 6100 (Max. trade discount 331/3%) Angle bend: £29.50 each. Semi-circle or gradual curve: £40.00 each

All prices shown exclude VAT

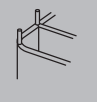

# Shower Rail Systems

## SG 6100 SG 6103

SG 6101 rail in silver anodised finish.  
SG 6103 in white.

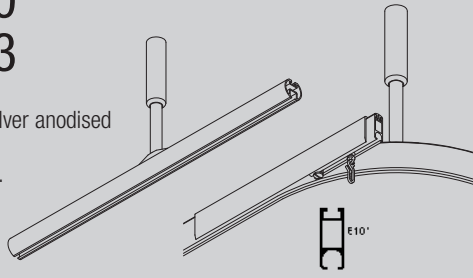

Price  
Qty.

Ready, complete, pre-packed with all accessories, including hanger rod(s) where applicable.

A

### System Prices

		6100 Silver	6103 White
Model A	91cm	£49.70	£85.09
	183cm	£78.25	£123.96
	213cm	£88.32	£136.66
	244cm	£100.38	£149.70



		6100 Silver	6103 White
Model B	76cmx76cm	£104.00	£156.10
	91cmx91cm	£113.86	£168.89

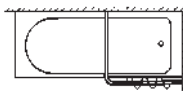

		6100 Silver	6103 White
Model C-left Model D-right	168cmx76cm	£132.60	£195.00

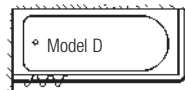
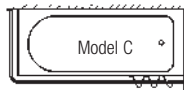

		6100 Silver	6103 White
Model E	91cmx76cm x91cm	£186.16	£237.62

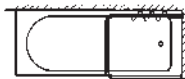

Special shapes for Shower Rails  
Send template and drawings for quotation.  
No special shapes on 1085

A

Colours  
Special order – see Page 73.

E

### Bending for special shower rails

Max. trade discount 33 1/3%

6101 Angle bend £21.50  
Semi-circle or gradual curve £29.50  
6103 Angle bend £53.50  
Semi-circle or gradual curve £70.50

All prices shown  
exclude VAT



# Cubicle, Room Divider Systems

Hospital Cubicle System available through approved Distributors only.

## SG 6100

Hospital Cubicle Safety Device System available through approved Distributors only – use in conjunction with System 6100

## SG 6650

## SG 6103

Supplied in satin silver finish and white in 6 metre lengths. Gold and chrome in 4 metre lengths

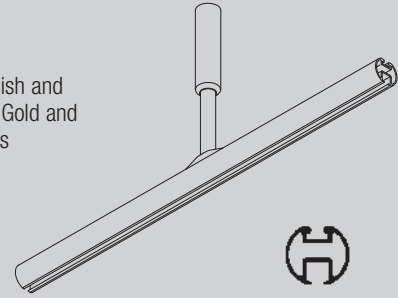

	Price Ctgy.
<b>Accessories</b>	<b>A</b>
6101 Rail, silver, white. Available in following lengths: 4.5m, 5.0m, 5.5m, 6.0m, 6.75m. Available in silver only.	
6007 Endstop, silver, white, ea, 10.	
6055 Twist eye endstop, each, 10.	
6083 Glider, 100. Self-service sachets. Outer 25 x 25.	
6094 Roller glider with hook, 10, 100.	
6096 Strip glider. Outer, 1,000.	
6098 Roller glider with eye, 10, 100.	
6110 Dustcover for 6101, white, m.	
6124 Twist double ceiling fixing plate, silver, white, each.	
6137 Ceiling fixing plate (single), silver, white.	
6138 Ceiling fixing plate (double), silver, white.	
6143 Rotating glider, 20, 100.	
6146 Nylon hook only, 12, 100.	
6147 Nylon glider hook, 20.	
Box 500 (on strips). Outer 9,500.	
6160 Track insert for 6100, each.	
6190 Hanger rod assembly complete in silver and white, 61cm (2') or 91cm (3') or to order.	
6191 Hanger tube, silver and white, per metre.	
6188 Ceiling support complete with stud 6193, silver and white, 50mm, each.	
6192 Ceiling support complete with stud 6193, silver and white, 100mm.	
6194 Track insert.	
6197 Hanger joint sleeve.	
6283 Roller glider, 10, 100.	
6501 'V' Hanger assembly system, silver, white.	
6503 Wall brackets complete, silver, white.	
25mm long with 50mm projection.	
50mm long with 50mm projection.	
100mm long with 50mm projection.	
200mm long with 50mm projection.	
50mm long with 100mm projection.	
100mm long with 100mm projection.	
75mm long with 150mm projection.	
6512 Connecting bridge, silver, white.	
6514 T-junction, single, silver, white.	
6524 Diagonal fixing support, silver, white.	
6525 Double 'T' junction, each, silver, white.	
6609 Wall support, grey.	
6611 End cover with screw, grey, white, each.	
6625A Complete fixing sleeve, silver, white.	
6199 Internal connecting bridge.	
6187 Dummy ceiling support sleeve, silver, white.	
6175 Mini hanger, silver, white.	
0554 Loading device access.	
0553 Connecting bridge for loading device.	
0552 Transfer unit for loading device.	

	Price Ctgy.
<b>Accessories</b>	<b>A</b>
6675 Safety device.	
6655 Wall support.	
6677 V-hanger safety device.	
6663 Wall bracket connector plate.	
6666 Safety connecting bridge.	
6669 Dustcap for 6650.	
6671 Washer insert for wall support.	
6672 Cover for washer insert.	
6679 Acrylic disc for wall support.	

	Price Ctgy.
<b>Accessories</b>	<b>A</b>
6103 Rail, silver and white, available in 6m lengths.	
6007 Endstop, silver, white, each, 10.	
6065 Twist eye endstop, each, 10.	
6083 Glider, 100. Self-service sachets. Outer 25 x 25.	
6094 Roller glider with hook, 10, 100.	
6096 Strip glider. Outer 1,000.	
6098 Roller glider with eye, 10, 100.	
6110 Dustcover, metre, white.	
6124 Twist double ceiling fixing plate, silver, white, each.	
6143 Rotating glider, 20, 100.	
6146 Nylon hook only, 12, 100.	
6147 Nylon glider hook, 20.	
Box 500 (on strips). Outer, 9,500.	
6188 Ceiling support complete with stud 6193, 50mm, white and silver.	
6190 Hanger rod assembly complete in silver and white.	
61cm (2') 91cm (3') or to order.	
6191 Hanger tube, silver and white, per metre.	
6192 Ceiling support complete with stud 6193, 100m each, silver, white.	
6194 Track insert.	
6197 Hanger joint sleeve, silver, white.	
6283 Roller glider, 10, 100.	
6501 'V' Hanger assembly system, silver, white.	
6503 Wall brackets complete, silver, white	
25mm long with 50mm projection.	
50mm long with 50mm projection.	
100mm long with 50mm projection.	
200mm long with 50mm projection.	
50mm long with 100mm projection.	
100mm long with 100mm projection.	
75mm long with 150mm projection.	
6511 White plastic cover.	
6514M T-junction, single, silver, white.	
6525 Double 'T' junction, silver, white.	
6527 Wall support, metal, white.	
6620 Wall support complete, each, 10. Grey, each, 10. White.	
6625A Complete fixing sleeve, silver, white.	
6630 End cover, grey, white.	
6631 90° connector piece, grey, white.	
6635 Internal connecting bridge.	
6521 External connecting bridge, silver, white.	
6524 Diagonal fixing support, silver, white.	
6175 Mini hanger.	

	Price Ctgy.
<b>Colours</b> (all colours except white and chrome special order – see page 73).	<b>E</b>
<b>Bends</b>	<b>33 1/3%</b>
Max trade discount	
Angle bend £53.50	
Semi-circle or gradual curve, £70.50	

All prices shown exclude VAT



# Electrically Operated Curtain Tracks

## SG 5100

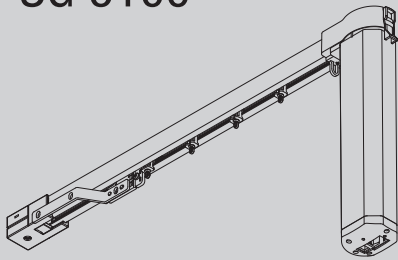

SG 5100 Base  
SG 5100R with Remote Control  
SG 5100T with Timer  
SG 5100TC with Total Control

## SG 5300

Electrically Operated  
Profile only 5301  
Supplied in silver and white.

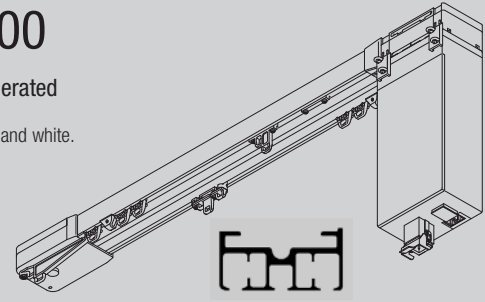

	Price Ctg.
<b>System Prices</b> Ready complete and assembled in white only.	
<b>SG 5100</b>	<b>A</b>
<b>Base</b>	
<b>Length</b>	
cm	£
100	460.52
150	479.93
200	499.41
250	518.80
300	538.20
350	557.59
400	577.00
450	596.38
500	615.79
<b>SG 5100R with Remote Control</b>	<b>A</b>
<b>Length</b>	
cm	£
100	520.41
150	539.81
200	559.20
250	578.60
300	598.00
350	617.39
400	636.79
450	656.26
500	675.67
<b>SG 5100T with Timer</b>	<b>A</b>
<b>Length</b>	
cm	£
100	605.40
150	624.80
200	644.19
250	663.59
300	682.99
350	702.38
400	721.78
450	741.18
500	760.57
<b>SG 5100TC Total Control option</b>	<b>A</b>
<b>Length</b>	
cm	£
100	665.29
150	684.67
200	704.08
250	723.47
300	742.87
350	762.26
400	781.66
450	801.05
500	820.45

	Price Ctg.
<b>SG 5100 (all models)</b>	<b>A</b>
For systems assembled with wave gliders please add the following supplement to standard system price.	
<b>Length</b>	
cm	
60mm	80mm
100	33.08 28.31
150	49.62 42.47
200	66.17 56.62
250	82.72 70.78
300	99.25 84.94
350	115.81 99.10
400	132.35 113.26
450	148.90 127.42
500	165.44 141.58
<b>Standard Accessories</b>	<b>A</b>
18R Screw 25mm	
0286 Cable Clips	
1148C Countersunk screw No.8 31mm	
5190 Motor	
10815 Cover White	
10823 Belt Connector Arm	
10824 Belt Connector Pin	
10825 Drive Belt	
10836 Hook White	
10867 M4 x 16 screw	
10925 Profile	
10926 Clamp	
10931 Roller Glider	
10933 Belt Return & Motor Holder Set White	
10936 Overlap Arm Set	
10940 Belt Return	
10945 Endstop	
10949 1 Channel Wall Transmitter White	
11116 Smart Fix Bracket Cover.	
11120 Smart Fix 100mm Bracket (11202 Set).	
<b>Optional Accessories</b>	<b>A</b>
6349 Wave Curtain Tape FR	
6363 Webbing Tape 70mm. For Wave Curtain 100m	
10905 Glider Cord 80mm for 6.5mm Channel	
10906 Glider Cord 60mm for 6.5mm Channel	
10943 Connecting Bridge	
10946 1 Channel Transmitter White	
10947 2 + 1 Channel Transmitter	
10948 6 + 1 Channel Transmitter	
10950 2 + 1 Channel Wall Transmitter	
10951 5 + 1 Channel Wall Transmitter	
11092 Timer White	
<b>Smart Fix Brackets in white or silver</b>	
11118 Smart Fix 60mm Bracket (11200 Set).	
11119 Smart Fix 80mm Bracket (11201 Set).	
11121 Smart Fix 120mm Bracket (11203 Set).	
11122 Smart Fix 150mm Bracket (11204 Set).	
11123 Smart Fix 200mm Bracket (11205 Set).	
<b>Square Smart Fix Brackets in white or silver</b>	
11139 Smart Fix 60mm Bracket (11210 Set).	
11140 Smart Fix 80mm Bracket (11211 Set).	
11141 Smart Fix 100mm Bracket (11212 Set).	
11142 Smart Fix 120mm Bracket (11213 Set).	
11143 Smart Fix 150mm Bracket (11214 Set).	
11144 Smart Fix 200mm Bracket (11215 Set).	
11137 Square Smart Fix Bracket Cover.	
<b>Universal Smart Fix Extension Bracket in white or silver</b>	
11154 Universal Smart Fix 120mm.	
11155 Universal Smart Fix 150mm.	
11156 Universal Smart Fix 200mm.	
0722 2mm Allen Key	<b>E</b>
<b>Bending</b>	<b>33 1/3%</b>
Max. trade discount	
Max 2 no. 90° bends or one curve. £148.00.	
<b>Note:</b> Autoglide is made-to-measure and cannot be cut down.	

	Price Ctg.
<b>System Prices</b> Ready complete and assembled	<b>C</b>
<b>Length</b>	<b>£</b>
M	
2	3238.79
3	3358.55
4	3478.32
5	3598.11
6	3717.85
7	3837.63
8	3957.42
9	4077.20
10	4196.99
11	4316.78
12	4436.54
13	4556.29
14	4676.12
15	4795.89
16	4915.68
17	5035.44
18	5155.24
19	5275.03
20	5394.80
21	5514.60
22	5634.34
23	5754.14
24	5873.90
25	5993.73
Track lengths between those specified will be charged at the rate for the nearest metre above. Satin silver or white as standard.	
<b>Standard Accessories</b>	<b>C</b>
5339 Lead with in-line connector	
5301 Profile, 6 metre length silver, white.	
5304 Endpiece set, white, grey.	
5310 Return set, white, grey.	
5312 Endstop.	
5317 Master carrier set.	
5318 Motor support.	
5320 Clamp.	
5302 Cylinder belt, per metre.	
5360 Motor.	
6098 Roller glider, at 10 per metre, 10, 100.	<b>A</b>
6086 Spring stop, each, 10, 100.	

	Price Ctg.
<b>Optional Accessories</b>	<b>A</b>
0565 Non-latching switch.	
6094 Roller glider with hook, 10, 100.	
<b>Universal Smart Fix Extension Brackets in white or silver</b>	
11154 Universal Smart Fix 120mm.	
11155 Universal Smart Fix 150mm.	
11156 Universal Smart Fix 200mm.	
0270 RACUB module.	<b>C</b>
0578 Recess pattress, metal.	
5319 Connecting bridge.	
5670 Overlap arm (single stack).	
<b>Colours</b> Other colours special order – see page 73.	<b>E</b>
<b>Bends</b>	<b>25%</b>
Max. trade discount	
For each bend add the following to above system price: Single angle bend £352.50 Semi-circle or gradual curve £644.50	
<b>Multiple System Operation</b>	<b>C</b>
A wide range of multiple operation methods are available, including low voltage control, radio/remote control and mixed systems. Can be controlled through a smartphone, tablet or desktop with the Silent Gliss app 'Move'.	
Please consult the Silent Gliss catalogue.	

All prices shown exclude VAT

All prices shown exclude VAT



# Electrically Operated Curtain Tracks

## SG 5600

Electrically Operated  
Profile only 10850  
Supplied in white and anodised silver.  
Coordinating endpiece set  
and motor (white/grey).

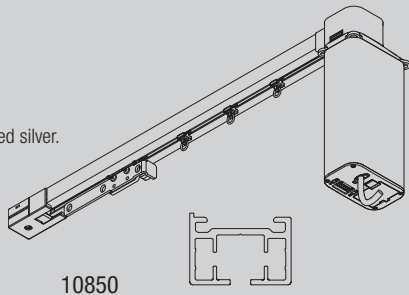

10850

	Price Ctgy.
<b>System Prices</b>	<b>C</b>
SG 5600 (9060 motor)	
Ready complete and assembled	
*60mm wave is only applicable for pair stack.	
*12m-25m: These limits do not allow auto programming mode, touch and go or manual override	

SG 5600 with std roller glider/std wave glider (60*/80mm)	
Shaded sizes are only applicable to standard roller glider (not standard wave)	

Length			
M	£	M	£
1.5	1255.79	13.5	1926.21
2.0	1283.37	14.0	1953.82
2.5	1310.91	14.5	1981.40
3.0	1338.45	15.0	2009.00
3.5	1366.03	15.5	2036.60
4.0	1393.57	16.0	2064.19
4.5	1421.11	16.5	2091.79
5.0	1448.70	17.0	2119.38
5.5	1476.23	17.5	2146.97
6.0	1503.78	18.0	2174.58
6.5	1531.32	18.5	2202.16
7.0	1558.86	19.0	2229.76
7.5	1586.40	19.5	2257.35
8.0	1613.94	20.0	2284.95
8.5	1641.48	20.5	2312.54
9.0	1669.02	21.0	2340.14
9.5	1696.56	21.5	2367.73
10.0	1724.10	22.0	2395.33
10.5	1751.64	22.5	2422.92
11.0	1779.18	23.0	2450.51
11.5	1806.72	23.5	2478.11
12.0	1834.26	24.0	2505.70
12.5	1861.80	24.5	2533.30
13.0	1889.34	25.0	2560.90

5600 with roller wave glider (60*/80mm)			
Length			
M	£	M	£
1.5	1306.04	13.5	2378.46
2.0	1350.37	14.0	2422.81
2.5	1394.66	14.5	2467.15
3.0	1438.96	15.0	2511.49
3.5	1483.26	15.5	2555.84
4.0	1527.56	16.0	2600.18
4.5	1571.86	16.5	2644.53
5.0	1616.18	17.0	2688.87
5.5	1660.47	17.5	2733.22
6.0	1704.78	18.0	2777.56
6.5	1749.08	18.5	2821.90
7.0	1793.38	19.0	2866.25
7.5	1837.68	19.5	2910.59
8.0	1881.98	20.0	2954.94
8.5	1926.28	20.5	2999.28
9.0	1970.58	21.0	3043.62
9.5	2014.88	21.5	3087.97
10.0	2059.18	22.0	3132.31
10.5	2103.48	22.5	3176.66
11.0	2147.78	23.0	3221.00
11.5	2192.08	23.5	3265.35
12.0	2236.38	24.0	3309.69
12.5	2280.68	24.5	3354.03
13.0	2324.98	25.0	3398.38

SMART by Silent Gliss - For SG 5600 control via third party control systems, please add the below per system:	C
11270 Plug in RS 485 motor module	
Add £195.00 per system	
**Power supplies not included - see separate associated components prices, page 28.	

SG 5600 with radio module, std roller glider/std wave glider (60*/80mm)			
Length			
M	£	M	£
1.5	1430.54	13.5	2100.93
2.0	1458.07	14.0	2128.53
2.5	1485.59	14.5	2156.12
3.0	1513.16	15.0	2183.71
3.5	1540.73	15.5	2211.31
4.0	1568.27	16.0	2238.90
4.5	1595.83	16.5	2266.50
5.0	1623.37	17.0	2294.09
5.5	1650.93	17.5	2321.69
6.0	1678.47	18.0	2349.28
6.5	1714.92	18.5	2376.88
7.0	1742.46	19.0	2404.46
7.5	1770.02	19.5	2432.07
8.0	1797.57	20.0	2459.66
8.5	1825.12	20.5	2487.25
9.0	1852.65	21.0	2514.85
9.5	1880.21	21.5	2542.44
10.0	1907.77	22.0	2570.04
10.5	1935.37	22.5	2597.63
11.0	1962.95	23.0	2625.22
11.5	1990.56	23.5	2652.83
12.0	2018.14	24.0	2680.41
12.5	2045.74	24.5	2708.01
13.0	2073.33	25.0	2735.60

SG 5600 with radio module and roller wave glider (60*/80mm)			
Length			
M	£	M	£
1.5	1480.78	13.5	2553.17
2.0	1525.07	14.0	2597.51
2.5	1569.34	14.5	2641.86
3.0	1613.65	15.0	2686.20
3.5	1657.97	15.5	2730.55
4.0	1702.27	16.0	2774.89
4.5	1746.57	16.5	2819.24
5.0	1790.87	17.0	2863.58
5.5	1835.17	17.5	2907.92
6.0	1879.47	18.0	2952.27
6.5	1923.76	18.5	2996.61
7.0	1976.96	19.0	3040.96
7.5	2021.27	19.5	3085.30
8.0	2065.55	20.0	3129.64
8.5	2109.86	20.5	3173.99
9.0	2154.15	21.0	3218.33
9.5	2198.45	21.5	3262.68
10.0	2242.76	22.0	3307.02
10.5	2287.07	22.5	3351.37
11.0	2331.45	23.0	3395.71
11.5	2375.79	23.5	3440.05
12.0	2420.14	24.0	3484.40
12.5	2464.48	24.5	3528.74
13.0	2508.83	25.0	3573.09

	Price Ctgy.
<b>Standard Accessories</b>	<b>C</b>
0766 In-line connector	
3004 Clamp	
9060 Motor, white, grey	
10816 Motor cover, white, grey	
10817 Motor case holder, white, grey	
10819 Belt return, white, grey	
10820 Overlap arm, straight, white	
10821 Overlap arm, bent, white	
10822 Master carrier set	
10826 Overlap arm support set	
10837 Pilot runner arm	
10838 Pilot runner set	
10840 Roller glider, 10, 100	
10850 Profile, white, silver, per metre	

	Price Ctgy.
<b>Standard Accessories</b>	<b>A</b>
10815 Cover, white, grey	
10825 Belt	
10836 Mask pair stack, white, grey	

	Price Ctgy.
<b>Optional Accessories</b>	<b>C</b>
3041 Bracket	
6794 Screw for direct fix	
9063 Radio module set for 0450	
9063EL Radio module set for 9940	
9960 Move Server Set (includes 1 x transmitter stick)	
9961 Move Transmitter Stick	
10862 Recess profile, white, per metre	
10863 Recess mask, motor, white	
10864 Recess mask, belt return, white	
10865 Mounting support plate	
10821L Long overlap arm bent	
10822 Master carrier set, white	
10831 Connecting bridge	
10838 Pilot runner set, white	
10844 Wave end stop, motor, grey, white	
10845 Wave master carrier, single stack 80mm	
10852 Wave roller glider cord (80mm pitch), 6.5mm channel	
10856 Wave end stop, belt return, white, grey	
10869 Wave roller glider cord (60mm pitch), 6.5mm channel	
10886 Wave overlap arm, pilot runner set	
10887 Wave overlap arm set	
10926 Wave glider support	
5118 Wedge for recess profile	

	Price Ctgy.
<b>Optional Accessories</b>	<b>A</b>
3615 Clamp	
3832 Twist clamp	
3582 Curtain hook, box, 100.	
Self-service sachets, 25 x 25.	
Outer, 20,000	
6094 Roller glider with hook, 10, 100	
6349 Wave @ curtain tape	
6363 Top hemming tape	
7002 Profile protector	
10075 Lead weight 50 gr/m	
10076 Fabric weight	
10823 Belt connector arm	
10824 Belt connector pin	
10854 Wave overlap support arm, white	
10905 Wave glider cord (80mm pitch), 6.5mm channel	
10906 Wave glider cord (60mm pitch), 6.5mm channel	
10924 Wave glider support	
11116 Smart Fix Bracket Cover.	
11137 Square Smart Fix Bracket Cover.	
<b>Smart Fix Brackets in white or silver</b>	
11118 Smart Fix 60mm Bracket (11200 Set).	
11119 Smart Fix 80mm Bracket (11201 Set).	
11120 Smart Fix 100mm Bracket (11202 Set).	
11121 Smart Fix 120mm Bracket (11203 Set).	
11122 Smart Fix 150mm Bracket (11204 Set).	
11123 Smart Fix 200mm Bracket (11205 Set).	
<b>Square Smart Fix Brackets in white or silver</b>	
11139 Smart Fix 60mm Bracket (11210 Set).	
11140 Smart Fix 80mm Bracket (11211 Set).	
11141 Smart Fix 100mm Bracket (11212 Set).	
11142 Smart Fix 120mm Bracket (11213 Set).	
11143 Smart Fix 150mm Bracket (11214 Set).	
11144 Smart Fix 200mm Bracket (11215 Set).	
<b>Universal Smart Fix Extension Bracket in white or silver</b>	
11154 Universal Smart Fix 120mm.	
11155 Universal Smart Fix 150mm.	
11156 Universal Smart Fix 200mm.	

	Price Ctgy.
<b>Colours</b>	<b>E</b>
Add price per metre + per length	
Ab/Bl	£15.64 £16.56
Motor in grey, endpiece sprayed to match. Other colours special order, see page 73.	

<b>Bends</b>	<b>Max. trade discount</b>	<b>25%</b>
For each bend add the following to above system price:		
Radius/cm	Profile 10850	
25-99	£139.50	
Over 99	£261.50	
Note: If using recess profile, price profile 10862 individually (see index), plus add an additional 20% to the relevant bending charge above.		
Please note: Minimum radius for 5600 is 25cm. Minimum radius for 5600 with recess profile is 50cm.		

<b>Multiple System Operation</b>	<b>C</b>
A wide range of multiple operation methods are available, including low voltage control, radio/remote control and mixed systems. Can also be controlled through a smartphone, tablet or desktop with the Silent Gliss app 'Move' (refer to page 28 for pricing details). Please consult the Silent Gliss catalogue.	

All prices shown exclude VAT



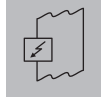

# Electrically Operated Curtain Tracks

## SG 5800

Electrically Operated



5810

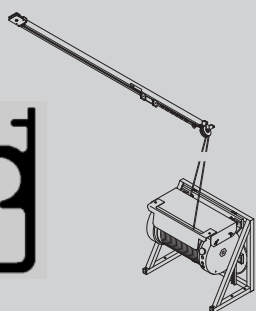

System Prices			Price Ctgy.
Ready complete and assembled (as far as possible depending on transport requirements).			<b>C</b>
Length M	Price Single Track £	Price 2 Parallel Tracks £	
12	17187.29	23650.91	
13	17542.57	24361.46	
14	17869.23	25014.79	
15	18195.89	25668.10	
16	18522.56	26321.45	
17	18849.23	26974.77	
18	19175.92	27628.13	
19	19531.17	28338.66	
20	19857.84	28992.01	
21	20184.51	29645.34	
22	20511.17	30298.66	
23	20837.84	30952.00	
24	21164.50	31605.33	
25	21519.78	32315.90	
26	21846.45	32969.23	
27	22173.13	33622.56	

SG 5800 can cover windows up to 60m if pair stacked. On lengths of this size Silent Gliss advice should be sought but as a guide price for each metre above 27m the following should be added:

Single width £305.87

Two tracks in parallel £611.76

Track lengths between those specified will be charged at the rate for the nearest metre above.

Price includes 6209 Top fix clamps, 5821/22 Wall mounting for motor, 5811 Overlap, 5809 Roller gliders at 5 per metre and where length exceeds 6 metres 6203 Connecting bridge. 5741 Plug, 5742 Surface socket and 0615 plastic switch with recess box. Earth is required.

### Standard Accessories

- 5806 Pilot Runner.
- 5809 Roller glider, 10.
- 5810 Silver profile only.
- 5824 Endstop.
- 5811 Overlap.
- 5814 Cable, metre.
- 5815 Cord guide return.
- 5816 Cord guide.
- 5834 Cable connector.
- 6203 Connecting bridge.
- 6209 Clamp, each, 10.

Optional Accessories			Price Ctgy.
0578 Recess pattress, metal.			<b>C</b>
0615 Latching switch			
6228 Double fixing plate.			
5829 2 Hole fixing plate.			
5813 Floor mounting frame.			
Colours			<b>E</b>
Special quotation.			
Bending	Max trade discount		<b>25%</b>
Radius cm	Each £		
32-99	290.50		
99-349	430.00		
over 350	561.50		
Remote/Multiple System Operation			<b>C</b>
Must not be wired in parallel. For information consult Silent Gliss			

All prices shown  
exclude VAT



# Switches, Remote Control & Multiple Operation of Motorised Systems

## SG 0450

Radio controlled systems

## SG 9940

Radio controlled systems

## SMART by Silent Gliss

For control via third party control systems

## Battery Operated Blinds

Remote and Wall Plates

All costs for systems indicated in this section are exclusive of curtain/blind systems and need to be added for total cost. On-site wiring costs are also excluded although advisory service is available. To assist choosing the correct equipment please see application chart in the back of the price list.

10949 come as standard with Battery Operated systems. This can not be exchanged/returned for another control.

	Price Ctg.
<b>SG 0450</b>	<b>C</b>
Radio control system, up to 255 room and blind addresses, individually or simultaneously. Use with mains electric systems (motor types A & B). Low voltage option (motor type C) available on request.	
0918 Control Module (motor type A)	£294.47
0919 Control Module (motor type B)	£294.47
0907 Control Module (low voltage motor type C)	£317.90
0913BS Single-channel wall switch – brushed silver	£230.62
0913MP Single-channel wall switch – mirror polished	£230.62
0913BR Single-channel wall switch – brass	£264.42
0914BS Eight-channel wall switch – brushed silver	£230.62
0914MP Eight-channel wall switch – mirror polished	£230.62
0914BR Eight-channel wall switch – brass	264.42
0336 Eight-channel hand-held remote	£180.00

	Price Ctg.
<b>Optional Accessories</b>	<b>C</b>
0917 White patress box	£20.59

	Price Ctg.
<b>SG 9940</b>	<b>C</b>
9068 Single-channel receiver	£392.30
9944 Single-channel receiver, non latching	£300.81
9945 Single-channel receiver, latching	£271.98
9946 Single-channel wall switch	£158.33
9947 Control Unit DC 24V	£177.75
9948 Single-channel programmable wall switch with timer	£395.85
10297 Solar sensor	£371.87
10300 Single-channel hand-held remote	£221.14
10302 5+1 channel hand-held remote	£221.14
10303 10+2+1 channel hand-held remote	£269.53
10804 15+5+1 channel hand-held remote	£269.53
Hand-held remotes are available in White, Silver or Anthracite	
Uplift for integrated 9940 receiver in Series 40 motors – Add on £195.00 per system for 4960/4970/2350/4760/4770/4780 Add on £250.00 per system for 4880	

	Price Ctg.
Uplift for integrated 9940 receiver for systems 2950 or 8960 Add on £237.82 per system for 2950 Add on £177.71 per system for 8960	<b>C</b>
Engraving of above remotes is available at £43.16 per remote. Delivery: 4 weeks.	<b>E</b>
<b>Move Server Set</b>	<b>C</b>
9960 Set (consists of server and transmitter stick)	£992.92
9961 Transmitter stick	£363.25

	Price Ctg.
0323 0.5m Blue Patch Cable	£1.85
10942 Power supply 24V DC	£51.15
11260 Gateway	£740.00
11261 Gateway KNX	£890.00
11262 Expansion Unit	£720.00
11263 Power supply 24V DC 2 Ampere DIN Rail	£29.16
11264 Power supply 24V DC 3.8 Ampere DIN Rail	£57.00
11265 Power supply 24V DC 5 Ampere DIN Rail	£60.33
11266 Power supply 24V DC 10 Ampere DIN Rail	£111.27
11270 RS 485 module set white	£195.00
11281 Cabinet up to 8 Shading Device Unit including Circuit Breaker Protection	£1170.00
11282 Cabinet up to 24 Shading Device Unit including Circuit Breaker Protection	£1508.00
11283 Cabinet up to 56 Shading Device Unit including Circuit Breaker Protection	£2860.00
11318 4-Pin Connector for 5600 SMART module	£9.30
11319 4-Pin Connector for SMART motor (Motor Side)	£9.30
11320 4-Pin Connector for SMART motor (Room Side)	£13.95
11325 6-Pin Connector for Gateway and Expansion Unit	£10.90

	Price Ctg.
11269 Hand held setting tool for Series 40 and SMART motors (TTPRO) Labour	£100.00
To fully assemble cabinet with SMART Gateway, expansion unit (if required) and Power Supplies:	<b>E</b>
Up to 8 systems (Labour cost only)	£102.70
Up to 24 systems (Labour cost only)	£166.40
Up to 56 systems (Labour cost only)	£188.50
SMART by Silent Gliss motors for use with Silent Gliss Gateway and associated components – Add on £195.00 per system for 4960/4970/2350/4760/4770/4780/5600 Add on £250.00 per system for 4880	

	Price Ctg.
<b>Battery Controls</b>	<b>C</b>
10949 1 Channel Wall Transmitter, White	£42.02
10950 2 + 1 Channel Wall Transmitter, White	£62.18
10951 5 + 1 Channel Wall Transmitter, White	£62.18
10946 1 Channel Remote	£50.67
10947 2 + 1 Channel Remote	£62.18
10948 6 + 1 Channel Remote	£62.18
11092 Single Channel Timer	£122.64

	Price Ctg.
<b>Fixed switches for mains control</b>	<b>C</b>
Switches are available single or in banks as below. Add switches price to price of system. Switches are designed for recess fixing.	
<b>Non-latching</b>	
1 Gang Switches 0565/W White plastic	£102.18
2 Gang Switches 0566/W White plastic	£176.89
3 Gang Switches 0567/W White plastic	£275.45
4 Gang Switches 0568/W White plastic	£350.17
6 Gang Switches 0569/W White plastic	£528.65
<b>Latching</b>	
1 Gang Switches 0615/W White plastic	£55.19
2 Gang Switches 0616 White plastic	£74.38
3 Gang Switches 0617 White plastic	£120.87
4 Gang Switches 0618 White plastic	£145.36
6 Gang Switches 0619 White plastic	£201.44
9952 Hard wired timer switch	£240.00

	Price Ctg.
<b>Extras</b>	
5736 Relay	£148.74
9953 Volt free interface	£192.97
<b>Tools</b>	<b>E</b>
11269 Handheld setting tool for Series 40 and SMART Motors TTPRO	£100.00

All prices shown exclude VAT



# Roman Blind Systems

## SG 2120

Chain operated headrail system for Roman Blinds. For medium to heavy weight applications.

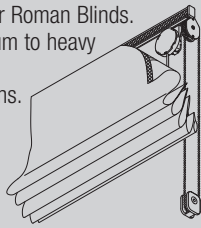

Price Ctg.

### SG 2120 System supplied ready assembled

A

Total max. curtain weight 8kg incl. any weighting.  
Maximum width: 4.0m  
Maximum drop: 6.0m

#### System width

cms	£
100	170.87
125	196.71
150	229.83
175	263.69
200	289.53
225	322.81
250	356.14
275	381.99
300	415.32
325	448.67
350	486.73
375	515.38
400	548.72

Above prices are based on standard accessories detailed below.

#### Standard Accessories

A

2049 Gear drive, each, 10, 100.  
2081 Take-up reel, each, 10.  
2059 Safety clip, 10.  
2111 Hexagonal bar, 6m length, outer of 50 lengths.  
2163 Flat drawing tape, per m, 100m  
2211 VELCRO® headrail, 6m, length.  
2179 End cover, each, 10.  
3630 Universal bracket, each, 10, 100.  
4845 Metal bead chain, 125m reel.

#### 2865 Twin chain connector, each.

C

#### 10400 Cord retainer.

E

#### Optional Accessories

A

0549 Touch and close pencil pleat tape for Austrian Blinds.  
3164 Breakaway hook and latch set.  
3165 Breakaway ring set (soft fold).  
3166 Breakaway ring tape (soft fold).  
2006 Bottom weight bar, 4m.  
2048 Bead chain, white, 100m reel.  
2072A Universal joint, each.  
2135 Steel rod, 3m lengths.  
2164/2164T Ring tape, 50m.  
2539 VELCRO® pile section, 25m, 100m.  
3069 Breakaway rod cover (hard fold).  
11116 Smart Fix Bracket Cover.  
11137 Square Smart Fix Bracket Cover.  
**Smart Fix Brackets in white or silver**  
11118 Smart Fix 60mm Bracket (11200 Set).  
11119 Smart Fix 80mm Bracket (11201 Set).  
11120 Smart Fix 100mm Bracket (11202 Set).  
11121 Smart Fix 120mm Bracket (11203 Set).  
11122 Smart Fix 150mm Bracket (11204 Set).  
11123 Smart Fix 200mm Bracket (11205 Set).

#### Square Smart Fix Brackets in white or silver

11139 Smart Fix 60mm Bracket (11210 Set).  
11140 Smart Fix 80mm Bracket (11211 Set).  
11141 Smart Fix 100mm Bracket (11212 Set).  
11142 Smart Fix 120mm Bracket (11213 Set).  
11143 Smart Fix 150mm Bracket (11214 Set).  
11144 Smart Fix 200mm Bracket (11215 Set).  
3603 Top fix brackets, each, 10, 100.  
3655 Long universal bracket.  
3660 Extra long universal bracket.  
4845BR Metal bead chain, brass.

#### Tools

0679 Connector tongs.

E

## SG 2304

Chain operated headrail system for Roman Blinds with integral child safety breakaway mechanism. For light to medium weight applications.

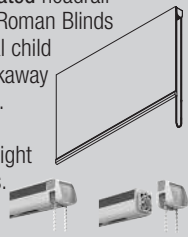

Price Ctg.

### SG 2304 System

A

Supplied made to measure, ready assembled.  
Maximum width: 2.0m  
Maximum drop: 3.4m

#### System width

cms	£
75	51.98
100	63.53
125	68.68
150	78.88
175	84.04
200	94.23

Above prices are based on standard accessories detailed below.

#### Please note:

Instead of standard metal operating chain, white plastic chain can be supplied at the same cost if required.

This system can also be supplied without the child safety breakaway mechanism at the same cost if required.

#### Standard Accessories

A

2301 Aluminium headrail white (5.8m).  
2309 Hex bar (5m).  
2308 Spool with lift cord.  
2306 Gear/Breakaway set (1:1).  
2302 Clip bracket.  
2311 Metal chain (150m reel).

#### Optional Accessories

A

(For existing parts check main price list)  
2310 Plastic operating chain (250m reel).  
2312 Bead chain joiner.  
2319 Plastic chain joiner.  
2316 Gear without breakaway mechanism (1:1).  
2346 Clamp bracket.  
2347/50 50cm finished plastic chain drop.  
2347/75 75cm finished plastic chain drop.  
2347/100 100cm finished plastic chain drop.  
2347/125 125cm finished plastic chain drop.  
2347/150 150cm finished plastic chain drop.  
2347/175 175cm finished plastic chain drop.  
2347/200 200cm finished plastic chain drop.

3164 Breakaway hook and latch set.  
3165 Breakaway ring set (soft fold).  
3166 Breakaway ring tape (soft fold).  
2004 Bottom bar.  
2006 Bottom bar.  
2135 Steel rod, 3m lengths.  
2164/2164T Ring tape, 50m.  
2539 VELCRO® pile section, 25m, 100m.  
3069 Breakaway rod cover (hard fold).  
11116 Smart Fix Bracket Cover.  
11137 Square Smart Fix Bracket Cover.

#### Smart Fix Brackets in white or silver

11118 Smart Fix 60mm Bracket (11200 Set).  
11119 Smart Fix 80mm Bracket (11201 Set).  
11120 Smart Fix 100mm Bracket (11202 Set).  
11121 Smart Fix 120mm Bracket (11203 Set).  
11122 Smart Fix 150mm Bracket (11204 Set).  
11123 Smart Fix 200mm Bracket (11205 Set).  
**Square Smart Fix Brackets in white or silver**  
11139 Smart Fix 60mm Bracket (11210 Set).  
11140 Smart Fix 80mm Bracket (11211 Set).  
11141 Smart Fix 100mm Bracket (11212 Set).  
11142 Smart Fix 120mm Bracket (11213 Set).  
11143 Smart Fix 150mm Bracket (11214 Set).  
11144 Smart Fix 200mm Bracket (11215 Set).

0600 Connector tongs for metal chain.  
7223 Tongs for connector 2865

10400 Cord retainer

E

## SG 2305

Chain operated headrail system for Roman Blinds with integral child safety breakaway mechanism. For medium to heavy weight applications.

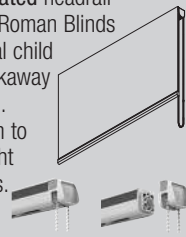

Price Ctg.

### SG 2305 System

A

Supplied made to measure, ready assembled.  
Maximum width: 3.0m  
Maximum drop: 3.4m

#### System width

cms	£
75	53.27
100	64.82
125	69.97
150	80.18
175	85.33
200	95.53
225	107.09
250	112.23
275	122.45
300	127.59

Above prices are based on standard accessories detailed below.

#### Please note:

Instead of standard metal operating chain, white plastic chain can be supplied at the same cost if required.

This system can also be supplied without the child safety breakaway mechanism at the same cost if required.

#### Standard Accessories

A

2301 Aluminium headrail white (5.8m).  
2309 Hex bar (5m).  
2308 Spool with lift cord.  
2307 Gear/Breakaway set (4:1).  
2302 Clip bracket.  
2311 Metal chain (150m reel).

#### Optional Accessories

A

(For existing parts check main price list)  
2310 Plastic operating chain (250m reel).  
2312 Bead chain joiner.  
2317 Gear without breakaway mechanism (4:1).  
2346 Clamp bracket.

2347/50 50cm finished plastic chain drop.  
2347/75 75cm finished plastic chain drop.  
2347/100 100cm finished plastic chain drop.  
2347/125 125cm finished plastic chain drop.  
2347/150 150cm finished plastic chain drop.  
2347/175 175cm finished plastic chain drop.  
2347/200 200cm finished plastic chain drop.

3164 Breakaway hook and latch set.  
3165 Breakaway ring set (soft fold).  
3166 Breakaway ring tape (soft fold).  
2004 Bottom bar.  
2006 Bottom bar.  
2135 Steel rod, 3m lengths.  
2164/2164T Ring tape, 50m.  
2539 VELCRO® pile section, 25m, 100m.  
3069 Breakaway rod cover (hard fold).  
11116 Smart Fix Bracket Cover.  
11137 Square Smart Fix Bracket Cover.

#### Smart Fix Brackets in white or silver

11118 Smart Fix 60mm Bracket (11200 Set).  
11119 Smart Fix 80mm Bracket (11201 Set).  
11120 Smart Fix 100mm Bracket (11202 Set).  
11121 Smart Fix 120mm Bracket (11203 Set).  
11122 Smart Fix 150mm Bracket (11204 Set).  
11123 Smart Fix 200mm Bracket (11205 Set).  
**Square Smart Fix Brackets in white or silver**  
11139 Smart Fix 60mm Bracket (11210 Set).  
11140 Smart Fix 80mm Bracket (11211 Set).  
11141 Smart Fix 100mm Bracket (11212 Set).  
11142 Smart Fix 120mm Bracket (11213 Set).  
11143 Smart Fix 150mm Bracket (11214 Set).  
11144 Smart Fix 200mm Bracket (11215 Set).

0600 Connector tongs for metal chain.  
7223 Tongs for connector 2865

10400 Cord retainer

E

All prices shown exclude VAT



# Roman Blind Systems

## SG 2345

Battery Operated

Battery operated radio controlled for Roman Blinds

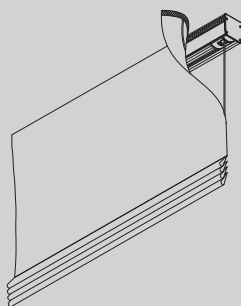

## SG 2350

Electrically Operated

For medium/heavy Roman Blinds.

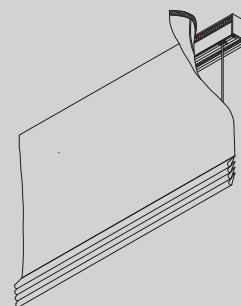

	Price Ctg.
<b>Battery operated</b>	<b>C</b>
<b>SG 2345 supplied ready assembled</b>	
Total maximum curtain weight 2.5kg. Maximum width 6 metres. Maximum drop 6 metres, maximum total surface area 36m <sup>2</sup> depending on curtain weight. Minimum width 60cm. Hardware only cost.	
<b>SYSTEM</b>	
<b>WIDTHS (cms)</b>	<b>£</b>
100	451.12
125	472.01
150	497.84
175	518.67
200	543.33
225	571.36
250	590.05
275	618.01
300	636.70
325	657.53
350	683.35
375	704.19
400	728.91
425	756.87
450	775.57
475	803.53
500	822.22
525	843.12
550	868.94
575	889.78
600	908.46
Above prices are based on Standard Accessories detailed below.	
<b>Standard Accessories</b>	<b>A</b>
1148C No.8 Cross Head Woodscrew	
2216 Cord	
2221 Hook Tape	
2351 Profile White for system 2345	
2352 Profile silver for system 2345	
3069 Breakaway Rod Cover	
10949 1 Channel Wall Transmitter White	
2353 Motor cover for system 2345	<b>C</b>
2354 Cover for system 2345	
2357 Pin for system 2345	
2358 Shell for system 2345	
2359 Support for system 2345	
2361 Adaptor for system 2345	
2363 Wall/Ceiling Bracket	
2368 Motor Adaptor Plate for SG2345	
3003 Clamp	
11071 Motor Drive for SG2345	
11074 Tube adaptor for SG2345	
11076 1.2nm Motor for 2345	
11077 Battery Box for Motor 11076	
11085 Battery Box Holder	
11099 Battery for 2345	

	Price Ctg.
<b>Optional Accessories</b>	<b>A</b>
3164 Breakaway bottom bar set	
3166 Breakaway ring set (soft fold)	
2135 Breakaway ring tape (soft fold)	
2136 Steel Rod	
3069 Breakaway rod cover (hard fold)	
2004 Bottom Bar	
2006 Weight bar	
10946 Radio hand-held transmitter 1 channel	
10947 Radio hand-held transmitter 2 + 1 channel	
10948 Radio hand-held transmitter 6 + 1 channel	
10950 Radio wall transmitter 2 channel	
10951 Radio wall transmitter 5 + 1 channel	
11092 Timer White	
<b>Smart Fix Brackets in white or silver</b>	
11118 Smart Fix 60mm Bracket (11200 Set).	
11119 Smart Fix 80mm Bracket (11201 Set).	
11120 Smart Fix 100mm Bracket (11202 Set).	
11121 Smart Fix 120mm Bracket (11203 Set).	
11122 Smart Fix 150mm Bracket (11204 Set).	
11123 Smart Fix 200mm Bracket (11205 Set).	
<b>Square Smart Fix Brackets in white or silver</b>	
11139 Smart Fix 60mm Bracket (11210 Set).	
11140 Smart Fix 80mm Bracket (11211 Set).	
11141 Smart Fix 100mm Bracket (11212 Set).	
11142 Smart Fix 120mm Bracket (11213 Set).	
11143 Smart Fix 150mm Bracket (11214 Set).	
11144 Smart Fix 200mm Bracket (11215 Set).	
<b>Smart Fix Bracket Covers</b>	
11116 Smart Fix Bracket Cover.	
11137 Square Smart Fix Bracket Cover.	
<b>Universal Smart Fix Extension Bracket in white or silver</b>	
11154 Universal Smart Fix 120mm.	
11155 Universal Smart Fix 150mm.	
11156 Universal Smart Fix 200mm.	
2362 Wire Holder	<b>C</b>
2521 Bracket	
8235 Wire Base Short	
8236 Wire Base Long	
8237 Wire Holder	
8249 Locking ring	

	Price Ctg.
<b>Electrically operated</b>	<b>C</b>
<b>2350 for straight vertically-hung Austrian, Roman and Festoon Blinds</b>	
Total maximum curtain weight 15kg. Maximum width 6 metres. Maximum drop 6 metres, maximum total surface area 36m <sup>2</sup> depending on curtain weight. Hardware cost only.	
<b>SYSTEM</b>	
<b>WIDTHS (cms)</b>	<b>£</b>
100	758.91
150	795.80
200	832.74
250	869.67
300	906.60
350	943.51
400	980.47
450	1017.39
500	1054.30
550	1091.24
600	1128.16
<b>Optional Accessories</b>	<b>A</b>
3164 Breakaway hook and latch set.	
3165 Breakaway ring set (soft fold).	
3166 Breakaway ring tape (soft fold).	
2004 Bottom bar	
2006 Bottom bar 1m, 5m	
2103T Transparent loop tape	
2109 Eyelet	
2144 Cross Rail	
2164 Ring Tape	
2539 Touch and close pile section, 25m, 100m	
2616 Bracket (40.8mm)	
3069 Breakaway rod cover (hard fold).	
11116 Smart Fix Bracket Cover.	
11137 Square Smart Fix Bracket Cover.	
<b>Smart Fix Brackets in white or silver</b>	
11118 Smart Fix 60mm Bracket (11200 Set).	
11119 Smart Fix 80mm Bracket (11201 Set).	
11120 Smart Fix 100mm Bracket (11202 Set).	
11121 Smart Fix 120mm Bracket (11203 Set).	
11122 Smart Fix 150mm Bracket (11204 Set).	
11123 Smart Fix 200mm Bracket (11205 Set).	
<b>Square Smart Fix Brackets in white or silver</b>	
11139 Smart Fix 60mm Bracket (11210 Set).	
11140 Smart Fix 80mm Bracket (11211 Set).	
11141 Smart Fix 100mm Bracket (11212 Set).	
11142 Smart Fix 120mm Bracket (11213 Set).	
11143 Smart Fix 150mm Bracket (11214 Set).	
11144 Smart Fix 200mm Bracket (11215 Set).	
2363 Wall/ceiling bracket	<b>C</b>
2521 Bracket (49.6mm)	

	Price Ctg.
<b>Remote/Multiple System Operation</b>	<b>C</b>
For system operation possibilities refer to table on page 92	
<b>Side-guide option available at an additional cost of £63.89.</b>	<b>C</b>
<b>System Control Options</b>	<b>C</b>
Radio control standard option is with System 0450, see page 28.	
<b>Series 40 motors</b> – With integrated radio receiver for operation with SG wireless system 9940 – add on £195.00 per system, see page 28.	
<b>SMART by Silent Gliss motors</b> – for use with Silent Gliss Gateway and associated components – add on £195.00 per system, see page 28.	

All prices shown exclude VAT



# Made-to-measure Roman Blinds

Prices below comprise of the complete system made-to-measure, ready-to-hang on either SG 2304 or SG 2305 with chosen fabric.

Maximum width 3m, maximum drop 3.4m. (Minimum system width 60cm).

Width Drop cm	PRICE GROUP 1											Width Drop cm
	100cm	120cm	140cm	160cm	180cm	200cm	220cm	240cm	260cm	280cm	300cm	
	Breeze Colorama 1 Colorama 1 Alu			*Colorama 2 Freshtex Light *Freshtex Linlook			*Sunset					Price Category 'A'
100	£322.98	£330.78	£354.24	£361.50	£368.82	£375.54	£399.54	£406.80	£414.06	£437.52	£444.30	100
120	£350.22	£358.38	£382.26	£390.42	£398.04	£405.72	£430.08	£437.76	£445.38	£469.20	£476.88	120
140	£376.74	£385.26	£409.50	£418.02	£426.60	£434.64	£459.36	£467.40	£476.46	£500.70	£508.74	140
160	£402.66	£412.14	£436.74	£446.16	£455.10	£463.56	£489.18	£497.58	£507.06	£531.66	£540.60	160
180	£429.18	£439.02	£464.52	£474.30	£483.12	£492.48	£518.46	£527.76	£537.60	£563.10	£572.46	180
200	£455.16	£465.84	£491.76	£501.96	£511.68	£521.40	£548.28	£558.00	£568.20	£594.06	£603.78	200
220	£482.34	£493.50	£519.72	£530.82	£540.96	£551.52	£578.28	£588.90	£599.52	£626.28	£636.36	220
240	£508.86	£520.32	£546.96	£558.48	£569.46	£580.44	£608.10	£619.08	£630.06	£657.24	£668.22	240
260	£534.84	£546.72	£574.74	£586.62	£597.96	£609.36	£637.38	£648.78	£661.14	£688.68	£700.08	260
280	£561.30	£573.54	£601.98	£614.22	£626.52	£638.28	£667.20	£678.96	£691.74	£719.64	£731.94	280
300	£587.28	£600.42	£629.22	£642.42	£655.02	£667.20	£696.48	£709.14	£722.28	£751.14	£763.26	300
320	£614.52	£628.02	£657.24	£670.74	£684.30	£697.32	£727.02	£740.10	£753.60	£782.82	£795.84	320
340	£640.98	£654.90	£685.02	£698.94	£712.32	£726.24	£756.36	£770.28	£784.20	£814.26	£827.70	340

Width Drop cm	PRICE GROUP 2											Width Drop cm
	100cm	120cm	140cm	160cm	180cm	200cm	220cm	240cm	260cm	280cm	300cm	
	*Freshtex Vision *Leviso Natural			*Reflex Silente 20 *Somnia			Twist					
100	£394.98	£402.78	£426.24	£433.50	£440.82	£447.54	£471.54	£478.80	£486.06	£509.52	£516.30	100
120	£429.42	£437.58	£461.46	£469.62	£477.24	£484.92	£509.28	£516.96	£524.58	£548.40	£556.08	120
140	£463.14	£471.66	£495.90	£504.42	£513.00	£521.04	£545.76	£553.80	£562.86	£587.10	£595.14	140
160	£496.26	£505.74	£530.34	£539.76	£548.70	£557.16	£582.78	£591.18	£600.66	£625.26	£634.20	160
180	£529.98	£539.82	£565.32	£575.10	£583.92	£593.28	£619.26	£628.56	£638.40	£663.90	£673.26	180
200	£563.16	£573.84	£599.76	£609.96	£619.68	£629.40	£656.28	£666.00	£676.20	£702.06	£711.78	200
220	£597.54	£608.70	£634.92	£646.02	£656.16	£666.72	£693.48	£704.10	£714.72	£741.48	£751.56	220
240	£631.26	£642.72	£669.36	£680.88	£691.86	£702.84	£730.50	£741.48	£752.46	£779.64	£790.62	240
260	£664.44	£676.32	£704.34	£716.22	£727.56	£738.96	£766.98	£778.38	£790.74	£818.28	£829.68	260
280	£698.10	£710.34	£738.78	£751.02	£763.32	£775.08	£804.00	£815.76	£828.54	£856.44	£868.74	280
300	£731.28	£744.42	£773.22	£786.42	£799.02	£811.20	£840.48	£853.14	£866.28	£895.14	£907.26	300
320	£765.72	£779.22	£808.44	£821.94	£835.50	£848.52	£878.22	£891.30	£904.80	£934.02	£947.04	320
340	£799.38	£813.30	£843.42	£857.34	£870.72	£884.64	£914.76	£928.68	£942.60	£972.66	£986.10	340

Width Drop cm	PRICE GROUP 3											Width Drop cm
	100cm	120cm	140cm	160cm	180cm	200cm	220cm	240cm	260cm	280cm	300cm	
	*Deep *Freshtex Dimout Newlife 1			Newlife 2 Silente 10								
100	£574.98	£582.78	£606.24	£613.50	£620.82	£627.54	£651.54	£658.80	£666.06	£689.52	£696.30	100
120	£627.42	£635.58	£659.46	£667.62	£675.24	£682.92	£707.28	£714.96	£722.58	£746.40	£754.08	120
140	£679.14	£687.66	£711.90	£720.42	£729.00	£737.04	£761.76	£769.80	£778.86	£803.10	£811.14	140
160	£730.26	£739.74	£764.34	£773.76	£782.70	£791.16	£816.78	£825.18	£834.66	£859.26	£868.20	160
180	£781.98	£791.82	£817.32	£827.10	£835.92	£845.28	£871.26	£880.56	£890.40	£915.90	£925.26	180
200	£833.16	£843.84	£869.76	£879.96	£889.68	£899.40	£926.28	£936.00	£946.20	£972.06	£981.78	200
220	£885.54	£896.70	£922.92	£934.02	£944.16	£954.72	£981.48	£992.10	£1002.72	£1029.48	£1039.56	220
240	£937.26	£948.72	£975.36	£986.88	£997.86	£1008.84	£1036.50	£1047.48	£1058.46	£1085.64	£1096.62	240
260	£988.44	£1000.32	£1028.34	£1040.22	£1051.56	£1062.96	£1090.98	£1102.38	£1114.74	£1142.28	£1153.68	260
280	£1040.10	£1052.34	£1080.78	£1093.02	£1105.32	£1117.08	£1146.00	£1157.76	£1170.54	£1198.44	£1210.74	280
300	£1091.28	£1104.42	£1133.22	£1146.42	£1159.02	£1171.20	£1200.48	£1213.14	£1226.28	£1255.14	£1267.26	300
320	£1143.72	£1157.22	£1186.44	£1199.94	£1213.50	£1226.52	£1256.22	£1269.30	£1282.80	£1312.02	£1325.04	320
340	£1195.38	£1209.30	£1239.42	£1253.34	£1266.72	£1280.64	£1310.76	£1324.68	£1338.60	£1368.66	£1382.10	340

Please note that blinds up to 2m wide x 3.4m drop will be supplied with system SG 2304 (1:1 gearing) as standard. Blinds exceeding 2m width and up to a maximum of 3m width will be supplied with SG 2305 (4:1 gearing) as standard.

All blinds are supplied unlined as standard, fabrics marked with an asterisk (\*) can be supplied with lining. We recommend that dim-out and black-out fabrics are lined to reduce pin holes.

For Standard Lining add 10%, for Blackout Lining add 15% to the pricing tables above.

For electric operation, either with system SG 2345 Battery or SG 2350 Mains operation please add the difference in hardware cost to pricing tables above. If SG 2345 is being supplied with above fabrics, please check fabric weight is within system limitations.

SG 2345 Pricing example:	Made to measure Roman, using PG1 Fabric at 1.2m wide x 2m drop =	£465.84
	Remove price of SG 2304 hardware at 1.25m wide =	£68.68
	Add on price for SG 2345 hardware at 1.25m wide =	£472.01
	Total price =	£869.17 (Category 'A')

All prices shown exclude VAT





# Sliding Panels

## SG 2700 Panel Glide

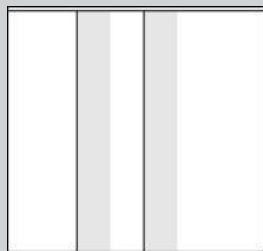

## SG 2730 Panel Flex

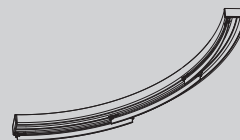

SG 2700 is delivered made to measure, ready assembled in **white**, top fix as standard. Panels either hang freely or can be connected and operated via a draw rod or cord at no extra cost.

SG 2730 is delivered made to measure, ready assembled in **white**. Panels either hang freely or can be connected and operated via a draw rod.

The systems are built up from different profiles with between 2 and 5 channels. Please consult the Silent Gliss catalogue to ensure you order the correct profile depending on how many panels and which stacking variation you require. Some technical restrictions apply.

Panels are usually between 50cm and 100cm and we recommend they overlap by approximately 10cm-15cm.

SG 2700 can be electrically operated in combination with SG 5600. For pricing, please add cost of 5600 Electric Track onto prices below. Please consult Silent Gliss for further information.

SG 2730 is only available as complete systems with fabric panels.

HARDWARE PRICES				Price Ctg.
<b>SG 2700 – Straight Only</b>				<b>C</b>
	<b>Manual</b>			
150cm	£324.67			
200cm	£407.92			
250cm	£491.16			
300cm	£574.41			
350cm	£657.67			
400cm	£740.90			
450cm	£824.15			
500cm	£907.39			
550cm	£989.06			
600cm	£1068.17			
<b>PRICES PER FABRIC PANEL (max drop 3m)</b>				
	<b>Up to</b>	<b>60cm - 130cm</b>		
	<b>60cm wide</b>	<b>wide</b>		
Price Group 1	£223.60	£288.06		
Price Group 2	£255.80	£334.15		
Price Group 3	£331.81	£459.96		
Price Group 4	£492.96	£666.14		
<b>FABRIC SUITABILITY</b>				
<b>Price Group 1</b>	<b>Price Group 2</b>	<b>Price Group 3</b>	<b>Price Group 4</b>	
Basic Screen 5%	Basic Screen 1%	Alutex	Aluscreen Futura	
Basic Screen 10%	Colorama 2	Colorama 2 Bioactive	Deep	
Breeze	Colorama 2 Alu	Freshtex Dimout		
Colorama 1	Dualscreen 1%	Lightscreen		
Colorama Alu 1	Dualscreen 3%	Linea		
Element	Dualscreen 5%	Moon		
Freshtex Light	Freshtex Linlook	Newlife Screen Alu		
Freshtex Ultralight	Freshtex Vision	Newlife 1		
Someo	Leviso	Newlife 2		
Sunset	Mercurio B	Optiscreen 4% Alu		
	Multi Shadow	Silente 10		
	Multi Visio	Twin Blackout		
	Multiscreen 1%	Umbrascreen		
	Multiscreen 5%			
	Multiscreen 10%			
	Natural			
	Newlife Screen			
	Nox			
	Optiscreen 4%			
	Reflex			
	Safescreen			
	Silente 20			
	Slimscreen			
	Somnia			
	Twist			
	Versascreen 1%			
	Versascreen 5%			
	Versascreen 10%			
Supplied with roller gliders as standard, available with optional click-in gliders at no extra cost.				
Face fix brackets will carry an additional cost.				
All prices shown exclude VAT				

HARDWARE PRICES				Price Ctg.
<b>SG 2730 – Straight or Curved</b>				<b>C</b>
	<b>Manual</b>			
150cm	£354.01			
200cm	£460.27			
250cm	£566.50			
300cm	£672.75			
350cm	£779.01			
400cm	£885.24			
450cm	£991.52			
500cm	£1097.76			
550cm	£1204.00			
600cm	£1310.26			
<b>PRICES PER FABRIC PANEL (max drop 3m)</b>				
	<b>Up to</b>	<b>60cm - 130cm</b>		
	<b>60cm wide</b>	<b>wide</b>		
Price Group 1	£223.60	£288.06		
Price Group 2	£255.80	£334.15		
Price Group 3	£331.81	£459.96		
Price Group 4	£492.96	£666.14		
<b>FABRIC SUITABILITY</b>				
<b>Price Group 1</b>	<b>Price Group 2</b>	<b>Price Group 3</b>		
Breeze	Colorama 2	Freshtex Dimout		
Someo	Freshtex Light	Linea		
Colorama 1	Freshtex Linlook	Newlife 1		
Colorama 1 Alu	Freshtex Vision	Newlife 2		
	Freshtex Ultralight	Silente 10		
	Leviso			
	Natural			
	Reflex			
	Silente 20			
	Twist			
	Somnia			
<b>BENDS</b>				
		<b>Max. trade discount</b>	<b>25%</b>	
For each bend add the following to the above system price				
Angle bend	£449.50			
Gradual curve	£722.00			
<b>SG 2730</b>				
10399 Design Fascia	£24.14 per metre, plus £3.93 per system		<b>A</b>	
All prices shown exclude VAT				



# Sliding Panels

## SG 2740 Wave Panel

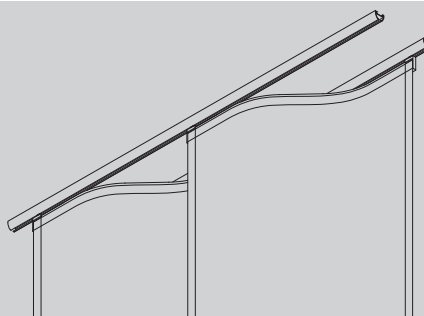

SG 2740 Wave Panel is delivered made to measure, ready assembled in white. Panels can be moved individually or connected. For applications up to a height of 2.8m. Two types of Carrier Type A (standard) (Right Wave) and Type B (Left Wave). Please see catalogue page for more information on carriers and stacking. System available with Silent Gliss fabrics only.

					Price Ctgy.
Prices complete with hardware and fabric.					<b>C</b>
<b>Connected System</b>					
Widths (cm)	Price Group 1 £	Price Group 2 £	Price Group 3 £	Number of Panels	
100-125	874.96	966.98	1184.14	3	
126-165	1145.14	1267.83	1557.39	4	
166-205	1415.92	1569.29	1931.23	5	
206-245	1686.10	1870.14	2304.47	6	
246-285	1956.28	2171.00	2677.72	7	
286-325	2226.47	2471.85	3050.96	8	
326-365	2496.65	2772.71	3424.20	9	
366-405	2767.43	3074.16	3798.05	10	
406-445	3037.61	3375.02	4171.29	11	
446-485	3307.79	3675.87	4544.54	12	
486-525	3577.98	3976.73	4917.78	13	
526-565	3848.16	4277.58	5291.02	14	
566-605	4109.32	4569.42	5655.25	15	
<b>Unconnected System</b>					
Widths (cm)	Price Group 1 £	Price Group 2 £	Price Group 3 £	Number of Panels	
100-136	857.67	949.69	1166.86	3	
137-181	1131.34	1254.04	1543.59	4	
182-226	1396.59	1549.96	1911.90	5	
227-272	1661.25	1845.29	2279.62	6	
273-317	1925.90	2140.61	2647.33	7	
318-363	2199.57	2444.95	3024.06	8	
364-408	2464.82	2740.88	3392.37	9	
409-453	2729.47	3036.20	3760.09	10	
454-499	2994.12	3331.53	4127.80	11	
500-544	3258.77	3626.85	4495.51	12	
545-590	3532.44	3931.19	4872.24	13	
591-635	3797.09	4226.52	5239.95	14	
636-680	4061.74	4521.84	5607.67	15	
681-726	4335.41	4826.18	5984.40	16	
727-771	4600.06	5121.51	6352.11	17	
772-817	4864.71	5416.83	6719.82	18	

Up to 280cm drop	Price Group 1	Price Group 2	Price Group 3
	Breeze	Colorama 2	Freshtex Dimout
	Colorama 1	Freshtex Linlook	Linea
	Colorama 1 Alu	Silent 20	Newlife
	Freshtex Light	Twist	Silente 10
	Freshtex Ultralight	Leviso	
	Someo	Freshtex Vision	
		Natural	

All prices shown  
exclude VAT



reddot design award  
winner



# Skylight Systems

## SG 2190

**Crank Operated**  
For curved, sloping or horizontal Roman Blinds.

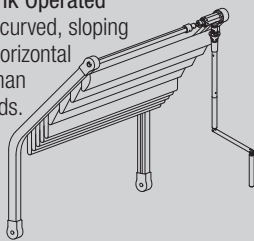

## SG 2195

**Electrically Operated**  
For curved, sloping or horizontal Roman blinds.

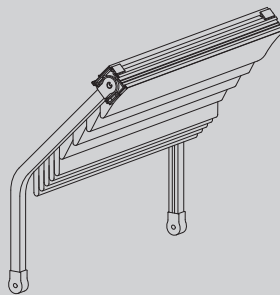

Made-to-measure Roman blinds for system 2190 and 2195

	Price Ctgy.
--	----------------

### SG 2190

#### Crank operated

##### Single System:

Max. width: 2.5m. Max. drop: 6m.

##### Double System:

Max. width: 3m. Max. drop: 6m.

These maximum sizes depend on the shape of system required – please check with Silent Gliss.

Max. fabric weight for both single/double system: 10kg.

Prices below are for hardware only – for complete system cost please add price for fabric.

##### Single System Prices

###### Silver or white

Width > Drop (cms)	Up to 100cm £	101cm- 150cm £
150	840.72	891.41
200	932.31	983.04
250	1023.95	1074.67
300	1115.62	1166.29
350	1207.30	1258.00
400	1298.94	1349.66
450	1390.60	1441.29
500	1482.25	1532.90
550	1573.83	1593.62
600	1665.47	1716.20

Width > Drop (cms)	151cm- 200cm £	201cm- 250cm £
150	942.12	992.82
200	1033.76	1084.47
250	1125.40	1176.15
300	1217.10	1267.78
350	1308.73	1359.38
400	1400.33	1451.09
450	1491.98	1542.69
500	1583.60	1634.35
550	1675.32	1726.03
600	1766.91	1817.66

##### Double System Prices

###### Silver or white

If under 2500mm: Please add 30% to single system prices above.

Width > Drop (cms)	251cm- 300cm £	Width > Drop (cms)	251cm- 300cm £
150	1291.84	400	1859.24
200	1405.47	450	1972.77
250	1518.93	500	2086.27
300	1632.35	550	2199.70
350	1745.85	600	2313.21

##### Components

3825 Clamp, 10, 100.

2189 Gear

2230 Endpiece, white or grey.

2759 Rod.

5130 Belt.

2242 Connector.

2746 Detachable crank handle.

2156 Drive shaft.

3036 Bracket (single clamp)

2139 Bracket (double clamp)

2248 Cross rod.

##### Bending

Max. trade discount

25%

Add the following to above system price:

Radius/cm	Single System	Double System
25-99	£275.00	£550.00
Over 99	£522.00	£1044.00

	Price Ctgy.
--	----------------

### SG 2195 Electrically Operated

Total max. curtain weight 25kg. (including cross profiles). Max. width: 3m. Max. drop: 6m.

System 2195 is also available as a double and treble system with 2190 as a slave system.

Max width achievable with double system: 6m, with treble system: 6m, other max. data as above.

Profile 2191 can be bent to a 25cm min. radius.

Supplied complete, hardware only, partially assembled including recessed switch and cross rods. Profile as standard in silver or white. For complete system cost please add price for fabric.

See page 92 for Radio Control options.

##### Single System Prices

Width > Drop (cms)	Up to 100cms £	101 cms- 150cms £	Silver or White		
			151 cms- 200 cms £	201 cms- 250 cms £	251 cms- 300 cms £
150	2275.90	2329.02	2382.18	2435.31	2488.44
200	2371.86	2425.06	2478.19	2531.34	2584.54
250	2467.93	2521.05	2574.18	2627.29	2680.46
300	2563.95	2617.04	2670.20	2723.34	2776.47
350	2659.96	2713.08	2766.21	2819.34	2872.48
400	2755.91	2809.08	2862.27	2915.37	2968.51
450	2851.95	2905.12	2958.26	3011.34	3064.49
500	2947.95	3001.10	3054.25	3107.38	3160.54
550	3044.00	3097.13	3150.27	3203.39	3256.58
600	3139.99	3193.13	3246.31	3299.42	3352.58

##### Double System Prices

Width > Drop (cms)	Up to 200cms £	Silver or White		
		201 cms- 300cms £	301 cms- 400 cms £	401 cms- 600 cms £
150	2842.10	2946.03	3049.88	3257.59
200	3029.80	3133.60	3237.56	3445.27
250	3217.46	3321.33	3425.22	3632.97
300	3405.14	3509.06	3612.87	3820.60
350	3592.76	3696.66	3800.51	4008.19
400	3780.45	3884.33	3988.15	4195.90
450	3968.08	4071.96	4175.83	4383.58
500	4155.74	4259.62	4363.49	4571.23
550	4343.40	4447.30	4551.12	4758.83
600	4531.11	4634.95	4738.78	4946.50

##### Treble System Prices

Width > Drop (cms)	Up to 300cms £	Silver or White		
		301 cms- 400cms £	401 cms- 500 cms £	501 cms- 600 cms £
150	3253.83	3408.40	3562.99	3640.33
200	3533.05	3687.72	3842.31	3919.57
250	3812.42	3967.08	4121.61	4198.89
300	4091.68	4246.26	4400.96	4478.20
350	4371.01	4525.59	4680.22	4757.53
400	4650.27	4804.90	4959.50	5036.79
450	4929.66	5084.21	5238.83	5316.10
500	5208.89	5363.54	5518.12	5595.40
550	5488.23	5642.86	5797.43	5874.70
600	5767.49	5922.11	6076.75	6154.00

##### Components

3825 Clamp, 10, 100

2230 Set, white or grey

5130 Belt

2160 Motor

2759 Cross Rod

2242 Connector

2156 Drive Shaft

2248 Cross Rod

2145 Telescopic glider

3036 Bracket (single clamp) silver or white

2139 Bracket (double clamp) silver or white

##### Bending

Max. trade discount

25%

Add the following to above system price:

Radius/cm	Single System	Double System	Treble System
25-99	£275.00	£550.00	£825.00
over 99	£522.00	£1044.00	£1575.50

	Price Ctgy.
--	----------------

### Fabric for curved, sloping or horizontal Skylight Systems 2190/2195/8700.

Made-to-measure Roman Blind for Systems 2190/2195.

Prices for made-up-blind, without hardware, per square metre.

Aluscreen Futura	£243.50 m <sup>2</sup>
Colorama 1	£162.00 m <sup>2</sup>
Colorama 1 Alu	£240.00 m <sup>2</sup>
Colorama 2	£192.50 m <sup>2</sup>
Colorama 2 Bioactive	£224.00 m <sup>2</sup>
Dualscreen 1%	£224.00 m <sup>2</sup>
Dualscreen 3%	£224.00 m <sup>2</sup>
Dualscreen 5%	£224.00 m <sup>2</sup>
Deep	£243.50 m <sup>2</sup>
Freshtex Dimout	£224.00 m <sup>2</sup>
Freshtex Vision	£192.50 m <sup>2</sup>
Lightscreen	£224.50 m <sup>2</sup>
Leviso	£157.50 m <sup>2</sup>
Multiscreen 1%	£224.50 m <sup>2</sup>
Multiscreen 5%	£224.50 m <sup>2</sup>
Multiscreen 10%	£192.50 m <sup>2</sup>
Newlife 1	£224.00 m <sup>2</sup>
Newlife 2	£224.00 m <sup>2</sup>
Reflex	£192.50 m <sup>2</sup>
Silente 10	£224.00 m <sup>2</sup>
Silente 20	£192.50 m <sup>2</sup>
Sunset	£162.00 m <sup>2</sup>
Versascreen 1%	£224.00 m <sup>2</sup>
Versascreen 5%	£224.00 m <sup>2</sup>
Versascreen 10%	£192.50 m <sup>2</sup>



# Skylight Systems

## SG 8600

Electrically Operated  
tension roller blind.

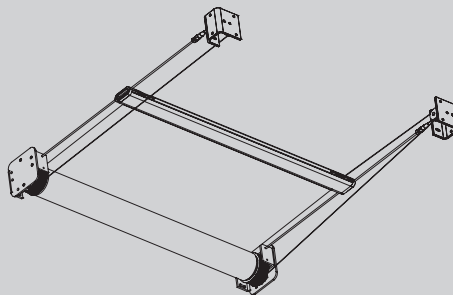

### SG 8600

Electrically operated tensioned roller blind system.  
Max. width: 4m. Max. drop: 6.5m

#### SG 8600 with Multiscreen 5% / Versascreen 5%

Price Category 'C'

Width ► Drop ▼	110cm	150cm	200cm	250cm	300cm	350cm	400cm	◀ Width ▼ Drop
100	2748.31	2775.64	2971.99	2999.73	3189.72	3223.86	3258.00	100
150	2777.23	2815.04	3024.52	3065.37	3268.54	3330.19	3363.04	150
200	2806.10	2854.42	3077.04	3131.06	3347.28	3407.73	3468.11	200
250	2835.00	2893.84	3129.57	3196.68	3426.10	3499.65	3573.19	250
300	2863.89	2933.20	3182.10	3262.36	3504.88	3591.58	3678.24	300
350	3018.28	3098.13	3353.78	3453.60	3712.37	3808.96	3908.78	350
400	3047.16	3137.52	3406.29	3519.23	3820.00	3900.90	4013.85	400
450	3076.04	3176.91	3458.82	3584.92	3866.77	3992.84	4118.90	450
500	3104.95	3216.32	3511.38	3650.58	3945.53	4084.74		500
550	3133.83	3255.71	3563.89	3716.23	4024.34	4176.67		550
600	3162.74	3295.12	3616.44	3781.91	4103.12			600
650	3191.62	3334.49	3668.96	3847.55	4181.92			650

#### SG 8600 with Aluscreen Futura / Lightscreen / Safescreen

Price Category 'C'

Width ► Drop ▼	110cm	150cm	200cm	250cm	300cm	350cm	400cm	◀ Width ▼ Drop
100	2778.34	2816.59	3026.52	3068.23	3271.57	3319.65	3367.12	100
150	2818.76	2871.66	3100.04	3159.77	3381.79	3447.97	3514.13	150
200	2859.21	2926.82	3173.54	3251.68	3492.07	3576.60	3661.14	200
250	2899.63	3013.99	3247.06	3311.52	3602.30	3705.23	3808.17	250
300	2940.04	3037.08	3320.57	3435.46	3712.60	3833.72	3955.16	300
350	3105.94	3217.72	3513.23	3652.88	3948.33	4088.34	4227.67	350
400	3146.39	3272.86	3587.05	3744.76	4058.59	4216.63	4374.68	400
450	3186.83	3327.96	3660.25	3836.63	4168.87	4345.26	4521.69	450
500	3227.27	3383.08	3733.75	3928.55	4279.12	4473.93		500
550	3267.68	3438.24	3807.26	4020.42	4389.41	4602.56		550
600	3340.15	3493.36	3880.77	4112.33	4499.64			600
650	3348.54	3548.47	3954.24	4204.19	4609.90			650

Motor is fitted as standard to the left. Should you require a right hand motor there will be an additional cost of £200.28.

Profiles are standard in white (RAL 9016). Alternative standard RAL colours are available at a cost of £300.00 (per system, nett, Cat E).



# Skylight Systems

## SG 8640

Electrically Operated  
Tensioned roller blind with fabric  
edge retention.

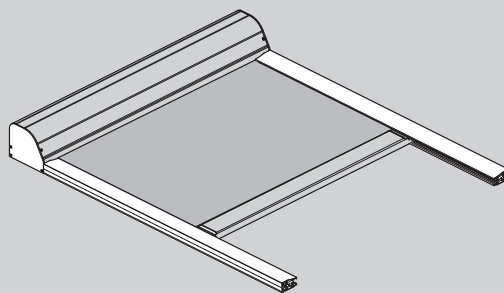

### SG 8640

Minimum width 650mm. Max width 3000mm  
Maximum length 4500mm. Systems over 3000mm length use a larger barrel & headbox.  
Please see catalogue for sizing limitations.

#### Price Group 1 – Nox, Mercurio B, Multiscreen 1% / 5% and Versascreen 1% / 5%

Price Category 'C'

Width ► Drop ▼	100cm	150cm	200cm	250cm	300cm	◀ Width ▼ Drop
150	3628.75	3945.32	4128.40	4426.06	4609.15	150
200	3865.38	4242.98	4487.09	4845.78	5089.89	200
250	3987.44	4426.06	4731.20	5150.92	5456.05	250
300	4109.49	4609.15	4975.31	5456.05	5822.22	300
350	4346.13	4906.81	5334.00	5875.77	6302.96	350
400	4468.18	5089.89	5578.11	6180.91	6669.13	400
450	4590.24	5272.97	5822.22	6486.04	7035.29	450

#### Price Group 2 – Aluscreen Futura and Moon

Width ► Drop ▼	100cm	150cm	200cm	250cm	300cm	◀ Width ▼ Drop
150	3700.05	4052.27	4271.01	4604.32	4823.05	150
200	3960.45	4385.59	4677.23	5083.45	5375.10	200
250	4106.28	4604.32	4968.87	5448.01	5812.56	250
300	4252.10	4823.05	5260.52	5812.56	6250.03	300
350	4512.50	5156.36	5666.74	6291.70	6802.07	350
400	4658.32	5375.10	5958.39	6656.25	7239.54	400
450	4804.14	5593.83	6250.03	7020.81	7677.01	450

White Hardware available as standard (RAL 9016 white). Alternative standard RAL colours are available at a cost of £300.00 (per system, nett, Cat E).

For use with remote, please see page 28 for external receivers and remote control options. Details on compatible receivers and remotes can be found on page 88 – 89.

All prices shown exclude VAT





# Vertical Blinds

## Vertical Waves by Eva Marmbrandt

Suitable for use on systems 2810, 2900, 2950. Not applicable for sloping systems.

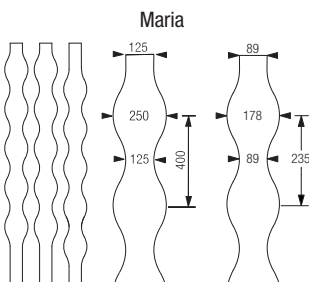
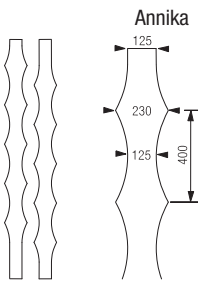
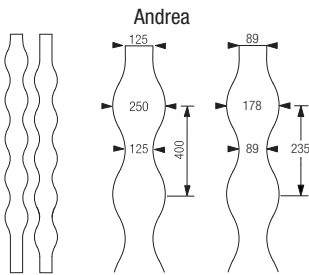

**Vertical Waves**  
Fabric Price Group 2  
Made in Multi Visio and Multi Shadow

Minimum and maximum system length as per individual system information.  
Minimum louvre drop 104cm (127mm)  
Maximum louvre drop 423cm (127mm)

Minimum louvre drop 110cm (89mm)  
Maximum louvre drop 364cm (89mm)

Minimum distance from wall 140mm  
Can be bent to large radius >6m.

Available as 89mm (Maria and Andrea) or 127mm louvres.

**3D Vertical Wave**  
Fabric Price Group 3 + Set up charge  
Made in Multi Visio  
Drop must be between 2.18m-2.97m

## SG 2810

Profile only 2601 available in 6 metre lengths.  
Cannot be bent. Headrail available in silver and white.

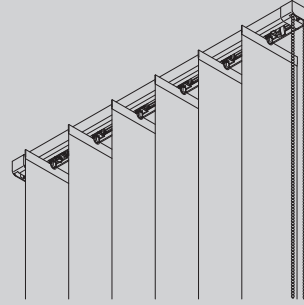

## SG 2810

Track and Accessories only

Maximum system width 5m (127mm) or 3.8m (89mm).

For guidance the following number of louvres per metre should be calculated:  
127mm/5" 10/metre  
89mm/3 1/2" 13/metre

**Track system only complete, assembled, ready to hang.**

Hardware only: in silver or white, no fabrics. Excluding bottom weights and link chain but including Top clips and 2616 bracket clamps. Operating chain 150cm standard. Wall fix brackets extra. Prices given are for 127mm/5" louvres. For 89mm/3 1/2" louvres add 15%.

Width up to cm	£	Price Ctg.
60	99.98	C
80	118.51	
100	137.05	
120	155.58	
140	174.07	
160	192.58	
180	211.06	
200	229.57	
220	248.10	
240	266.63	
260	285.03	
280	303.60	
300	322.12	
320	340.60	
340	359.14	
360	377.64	
380	396.12	
400	414.64	
420	433.18	
440	451.71	
460	470.23	
480	488.79	
500	507.34	

	Price Ctg.
<b>Standard Accessories</b> 2601 Profile only, silver or white. 2604 Guide. 2605 Top clip 127mm white. 2608 Endstop for 2601. 2610 Endstop. 2611 Stopper. 2616 Bracket. 2620 Pilot runner. 2623 Rotation element (123mm). 2625 Rotation element (89mm). 2813 Top clip 89mm white. 2865 Bead chain connector. 2872 Operating chain. 10400 Cord tidy	C
<b>Optional Accessories</b> 2471 Bottom weight 127mm. 2473 Bottom weight 89mm. 2479 Louvre connecting chain 127mm. 2481 Louvre connecting chain 89mm. 2606 Top clip 127mm (modified). 2607 Top clip 89mm (modified). 2614 Recess profile (suspended ceilings) 2615 Recess profile. 2618 Shaft. 2624 Adjustment element (101mm). 2824 Spacer (65mm). 5118 Wedge. 6268 Hanger.	C
<b>Smart Fix Bracket Covers</b> 11116 Smart Fix Bracket Cover. 11137 Square Smart Fix Bracket Cover.	A
<b>Smart Fix Brackets in white or silver</b> 11118 Smart Fix 60mm Bracket (11200 Set). 11119 Smart Fix 80mm Bracket (11201 Set). 11120 Smart Fix 100mm Bracket (11202 Set). 11121 Smart Fix 120mm Bracket (11203 Set). 11122 Smart Fix 150mm Bracket (11204 Set). 11123 Smart Fix 200mm Bracket (11205 Set).	
<b>Square Smart Fix Brackets in white or silver</b> 11139 Smart Fix 60mm Bracket (11210 Set). 11140 Smart Fix 80mm Bracket (11211 Set). 11141 Smart Fix 100mm Bracket (11212 Set). 11142 Smart Fix 120mm Bracket (11213 Set). 11143 Smart Fix 150mm Bracket (11214 Set). 11144 Smart Fix 200mm Bracket (11215 Set).	

**\*3D Vertical Waves**  
£360.50 set up charge.  
Please add to assembled prices  
Made in Multi Visio  
127mm Andrea Design only.

**Printing Information**  
All RAL colours applicable (except white, pearl and fluorescent colours).  
Height 218cm to 297cm  
5 shape louvre and 6 shape louvre.

## Fabric price categories

For SG 2810 complete with fabrics (see tables over)

### Price Group 1

Element  
Function  
Multi Shadow  
Multi Visio

### Price Group 2

Alutex  
Colorama 2  
Mercurio B  
Multiscreen 5%  
Optiscreen 4%  
Versascreen 1%  
Versascreen 5%  
Versascreen 10%  
Vertical Wave (Multi Visio, Multi shadow)

### Price Group 3

Colorama 2 Bioactive  
Moon  
Optiscreen 4% Alu  
Reflex  
3D Vertical Wave (Multi Visio)\*

All fabrics are available in 89mm and 127mm louvres (89mm add 15%).  
All above fabrics are FR.

All prices shown exclude VAT



# SG 2810 complete with fabric

The prices below comprise complete system, silver or white ready-to-hang, top fix, single or pair stack with fabric choice in 127mm/5" louvres (see fabric price categories). Includes bottom weights and bottom link cord to both sides. Wall fix brackets extra. For 89mm/3 1/2" louvres add 15%. If sizes lie between the measurements shown, the price for the next larger will apply. Set up costs apply for 3D vertical waves.

Price Category C

Width cm	UP TO 60			UP TO 80			UP TO 100			UP TO 120		
	1	2	3	1	2	3	1	2	3	1	2	3
Drop cm												
60	141.21	158.69	177.50	173.49	196.68	221.84	205.71	234.73	266.19	237.93	272.77	310.51
80	147.55	170.77	195.88	181.89	212.83	246.35	216.20	254.87	296.78	250.55	296.96	347.24
100	153.83	182.81	214.25	190.26	228.94	270.84	226.66	275.07	326.76	263.13	321.16	383.99
120	160.14	194.91	232.64	198.68	245.06	295.32	237.16	295.20	358.06	275.70	345.34	420.76
140	166.42	207.04	251.04	207.04	261.17	319.87	247.62	315.33	388.71	288.24	369.47	457.54
160	172.69	219.11	269.43	215.37	277.31	344.36	258.13	335.49	419.30	300.82	393.66	494.29
180	178.99	231.19	287.74	223.78	293.35	368.86	268.59	355.64	449.91	313.41	417.83	531.04
200	185.24	243.30	306.15	232.13	309.54	393.37	279.10	375.73	480.57	326.05	442.06	567.79
220	191.52	255.36	324.54	240.55	325.67	417.84	289.56	395.94	511.21	338.56	466.22	604.52
240	197.83	267.51	342.96	248.97	341.80	442.37	300.05	416.11	541.89	351.10	490.38	641.29
260	204.10	279.60	361.28	257.31	357.91	466.89	310.52	436.25	572.52	363.67	514.57	678.07
280	210.43	291.62	379.67	265.67	373.99	491.44	320.99	456.41	603.14	376.28	538.77	714.81
300	216.69	303.77	398.07	274.09	390.10	515.94	331.48	476.55	633.73	388.89	562.95	751.61
320	222.98	315.82	416.49	282.51	406.25	540.36	341.95	496.68	664.40	401.46	587.12	788.38
340	229.29	327.89	434.82	290.88	422.36	564.89	352.44	516.82	694.98	414.02	611.24	825.13
360	235.56	340.03	453.17	299.28	438.48	589.41	362.90	537.00	725.67	426.57	635.49	861.89
380	241.87	352.12	471.58	307.59	454.59	613.92	373.41	557.12	756.24	439.18	659.70	898.62
400	248.13	364.19	489.93	315.99	470.70	638.44	383.89	577.28	786.89	451.75	683.81	935.34

Width cm	UP TO 140			UP TO 160			UP TO 180			UP TO 200		
	1	2	3	1	2	3	1	2	3	1	2	3
Drop cm												
60	270.19	310.81	354.82	302.41	348.84	399.13	334.68	386.92	443.49	366.92	424.93	487.82
80	284.86	338.98	397.72	319.23	381.09	448.16	353.51	423.11	498.61	387.91	465.27	549.09
100	299.58	367.31	440.57	335.96	413.35	497.15	372.41	459.43	553.75	408.80	505.52	610.34
120	314.22	395.44	483.46	352.74	445.60	546.21	391.26	495.72	608.87	429.78	545.84	671.61
140	328.86	423.61	526.31	369.48	477.81	595.19	410.09	532.01	663.99	450.76	586.16	732.88
160	343.57	451.89	569.22	386.27	510.04	644.17	428.97	568.26	719.19	471.74	626.46	794.09
180	358.19	480.08	612.13	403.05	542.31	693.21	447.86	604.49	774.31	492.69	666.73	855.33
200	372.89	508.31	655.03	419.81	574.52	742.21	466.71	640.79	829.43	513.65	707.00	916.66
220	387.56	536.51	697.87	436.61	606.77	791.22	485.53	677.08	884.59	534.57	747.36	977.90
240	402.22	564.69	740.77	453.39	639.07	840.25	504.47	713.37	939.66	555.53	787.64	1039.19
260	416.92	592.93	783.61	470.13	671.26	889.24	523.31	749.65	994.84	576.49	827.91	1100.46
280	431.58	621.14	826.54	486.87	703.47	938.26	542.13	785.88	1049.96	597.48	868.22	1161.70
300	446.27	649.35	869.42	503.61	735.70	987.26	561.02	822.16	1105.08	618.43	908.51	1222.95
320	460.96	677.58	912.29	520.38	767.96	1036.28	579.90	858.46	1160.28	639.34	948.87	1284.22
340	475.57	705.75	961.96	537.21	800.28	1085.31	598.81	894.70	1215.38	660.36	989.20	1345.51
360	490.27	734.00	998.08	553.96	832.47	1134.31	617.66	931.01	1270.54	681.31	1029.43	1406.75
380	504.93	762.21	1040.96	570.74	864.71	1183.32	636.50	967.19	1325.65	702.30	1069.78	1468.00
400	519.65	790.44	1083.83	587.48	896.95	1232.29	655.35	1003.49	1380.79	723.21	1110.07	1484.70

Width cm	UP TO 220			UP TO 240			UP TO 260			UP TO 280		
	1	2	3	1	2	3	1	2	3	1	2	3
Drop cm												
60	399.11	462.97	532.15	431.32	500.99	576.45	463.62	539.04	620.76	495.84	577.08	665.12
80	422.23	507.28	599.54	456.55	549.35	649.98	490.81	591.43	700.43	525.22	633.48	750.90
100	445.24	551.63	666.87	481.71	597.73	723.46	518.09	643.85	780.00	554.58	689.91	836.66
120	468.31	595.96	734.31	506.83	646.11	797.00	545.39	696.24	859.75	583.86	746.33	922.45
140	491.38	640.30	801.69	532.01	694.44	870.51	572.61	748.61	939.34	613.22	802.78	1008.17
160	514.40	684.62	869.08	557.12	742.81	944.02	599.85	800.96	1018.98	642.57	859.20	1093.96
180	537.48	728.97	936.45	582.29	791.14	1017.56	627.12	853.37	1098.62	671.89	915.63	1179.75
200	560.53	773.31	1003.89	607.46	839.54	1091.06	654.34	905.74	1178.30	701.20	972.03	1265.47
220	583.54	817.68	1071.23	632.62	887.93	1164.54	681.56	958.21	1257.88	730.62	1028.50	1351.24
240	606.63	861.95	1138.64	657.74	936.24	1238.12	708.87	1010.56	1337.54	759.93	1084.90	1436.97
260	629.66	906.27	1205.97	682.92	984.61	1311.63	736.10	1062.95	1417.23	789.29	1141.29	1522.75
280	652.76	950.62	1273.38	708.01	1033.00	1385.15	763.37	1115.34	1496.83	818.60	1197.70	1608.57
300	675.84	994.96	1340.81	733.22	1081.35	1458.62	790.57	1167.79	1576.48	847.97	1254.14	1694.29
320	698.84	1039.29	1408.14	758.34	1129.72	1532.14	817.85	1220.18	1656.09	877.31	1310.58	1780.08
340	721.98	1083.61	1475.55	783.52	1178.05	1605.66	845.10	1272.55	1735.74	906.66	1367.00	1865.85
360	744.96	1127.93	1542.95	808.68	1226.43	1679.21	872.34	1324.89	1815.43	935.99	1423.43	1951.60
380	768.03	1172.29	1610.32	833.82	1274.78	1752.67	899.58	1377.32	1895.02	965.37	1479.85	2037.40
400	791.08	1216.61	1677.69	858.99	1323.17	1826.23	926.89	1429.71	1974.67	994.70	1536.25	2123.15

All prices shown exclude VAT



# SG 2810 complete with fabric

The prices below comprise complete system, silver or white ready-to-hang, top fix, single or pair stack with fabric choice in 127mm/5" louvres (see fabric price categories). Includes bottom weights and bottom link cord to both sides. Wall fix brackets extra. For 89mm/3 1/2" louvres add 15%. If sizes lie between the measurements shown, the price for the next larger will apply. Set up costs apply for 3D vertical waves.

Price Category C

Width cm	UP TO 300			UP TO 320			UP TO 340			UP TO 360		
	1	2	3	1	2	3	1	2	3	1	2	3
Drop cm												
60	528.08	615.17	709.47	560.31	653.17	753.76	592.59	691.19	798.06	624.76	729.21	842.44
80	559.52	675.58	801.35	593.88	717.61	851.77	628.17	759.70	902.27	662.52	801.78	952.68
100	590.95	736.07	893.25	627.41	782.15	949.82	663.85	828.24	1006.38	700.20	874.31	1062.95
120	622.39	796.48	985.11	660.88	846.61	1047.84	699.46	896.73	1110.48	738.00	946.87	1173.26
140	653.86	856.94	1077.02	694.49	911.04	1145.85	735.08	965.29	1214.67	775.71	1019.43	1283.48
160	685.27	917.41	1168.89	727.97	975.54	1243.85	770.73	1033.75	1318.82	813.45	1091.92	1393.78
180	716.76	977.85	1260.77	761.60	1040.02	1341.84	806.33	1102.28	1423.01	851.15	1164.50	1504.03
200	748.15	1038.27	1352.66	795.07	1104.55	1439.93	842.01	1170.79	1527.16	888.92	1237.04	1614.31
220	779.67	1098.74	1444.63	828.58	1169.04	1537.92	877.65	1239.33	1631.28	926.62	1309.56	1724.71
240	811.06	1159.16	1536.50	862.18	1233.50	1636.08	913.28	1307.81	1735.39	964.36	1382.16	1834.89
260	842.51	1219.65	1628.39	895.72	1297.98	1733.98	948.91	1376.32	1839.57	1002.06	1454.66	1945.16
280	873.93	1280.05	1720.29	929.28	1362.46	1832.00	984.50	1444.84	1943.69	1039.83	1527.21	2055.44
300	905.40	1340.52	1812.16	962.72	1426.95	1930.02	1020.16	1513.37	2047.91	1077.51	1599.74	2165.71
320	936.83	1401.01	1904.06	996.27	1491.40	2028.04	1055.73	1581.87	2151.97	1115.25	1672.30	2275.95
340	968.27	1461.44	1995.92	1029.86	1555.90	2126.04	1091.41	1650.38	2256.14	1153.04	1744.85	2386.25
360	999.70	1521.95	2087.85	1063.36	1620.39	2224.07	1127.07	1718.87	2360.23	1190.71	1817.39	2496.50
380	1031.12	1582.36	2179.77	1096.94	1684.88	2322.06	1162.66	1787.35	2464.43	1228.49	1889.96	2606.79
400	1062.59	1642.79	2271.61	1130.45	1749.38	2420.10	1198.29	1855.95	2568.54	1266.20	1962.47	2717.03

Width cm	UP TO 380			*UP TO 400			*UP TO 420			*UP TO 440		
	1	2	3	1	2	3	1	2	3	1	2	3
Drop cm												
60	657.04	767.26	886.75	689.27	805.30	931.08	721.56	843.37	975.38	753.72	881.39	1019.73
80	696.86	843.86	1003.20	731.16	885.93	1053.61	765.53	928.00	1104.03	799.84	970.05	1154.55
100	736.72	920.44	1119.57	773.08	966.52	1176.15	809.53	1012.62	1232.71	845.96	1058.74	1289.30
120	776.50	997.01	1235.96	815.05	1047.10	1298.62	853.55	1097.23	1361.35	892.07	1147.39	1424.08
140	816.38	1073.59	1352.34	856.95	1127.73	1421.13	897.57	1181.85	1490.00	938.21	1236.03	1558.86
160	856.16	1150.14	1468.73	898.87	1208.30	1543.68	941.58	1266.55	1618.69	984.32	1324.70	1693.61
180	895.97	1226.72	1585.12	940.81	1288.94	1666.19	985.59	1351.13	1747.34	1030.41	1413.37	1828.41
200	935.81	1303.27	1701.53	982.71	1369.51	1788.73	1029.59	1435.83	1875.97	1076.56	1502.04	1962.97
220	975.65	1379.89	1817.95	1024.63	1450.11	1911.27	1073.67	1520.46	2004.49	1122.63	1590.69	2097.88
240	1015.51	1456.47	1934.36	1066.54	1530.74	2033.80	1117.66	1605.01	2133.24	1168.76	1679.33	2232.73
260	1055.30	1533.01	2050.75	1108.47	1611.30	2156.29	1161.70	1689.74	2261.92	1214.87	1768.02	2367.49
280	1095.10	1609.56	2167.14	1150.41	1691.95	2278.86	1205.74	1774.31	2390.58	1260.99	1856.69	2502.25
300	1134.96	1686.13	2283.51	1192.28	1770.89	2401.36	1249.69	1858.94	2519.22	1307.10	1945.32	2637.05
320	1174.76	1762.72	2399.91	1234.20	1853.17	2523.95	1293.70	1943.60	2647.84	1353.13	2034.00	2771.85
340	1214.59	1839.32	2516.30	1276.17	1933.77	2646.46	1337.69	2028.19	2776.54	1399.30	2122.68	2906.59
360	1254.44	1915.89	2632.74	1318.08	2014.38	2768.95	1381.78	2112.93	2905.18	1445.43	2211.40	3041.39
380	1294.24	1992.50	2749.14	1359.99	2094.96	2891.48	1425.72	2197.47	3033.82	1491.52	2300.01	3176.14
400	1334.06	2068.98	2865.48	1401.90	2175.59	3014.00	1469.79	2282.11	3162.50	1537.70	2388.65	3310.95

Width cm	*UP TO 460			*UP TO 480			*UP TO 500		
	1	2	3	1	2	3	1	2	3
Drop cm									
60	785.99	919.44	1064.06	818.24	957.46	1108.37	850.46	995.51	1152.69
80	834.15	1012.10	1204.94	868.48	1054.18	1255.42	902.81	1096.23	1305.84
100	882.40	1104.85	1345.87	918.82	1150.95	1402.45	955.26	1197.02	1459.04
120	930.64	1197.52	1486.71	969.10	1247.66	1549.43	1007.64	1297.79	1612.15
140	978.77	1290.17	1627.69	1019.42	1344.34	1696.53	1060.00	1398.49	1765.34
160	1026.99	1382.93	1768.59	1069.78	1441.11	1843.51	1112.46	1499.26	1918.49
180	1075.23	1475.55	1909.55	1120.04	1537.77	1990.63	1164.85	1599.99	2071.72
200	1123.45	1568.31	2050.43	1170.36	1634.57	2137.66	1217.26	1700.82	2224.86
220	1171.64	1660.95	2191.14	1220.70	1731.22	2284.50	1269.67	1801.49	2377.71
240	1219.87	1753.69	2332.14	1270.96	1827.98	2431.64	1322.07	1902.28	2531.05
260	1268.14	1846.40	2473.08	1321.29	1924.73	2578.63	1374.52	2003.09	2684.24
280	1316.33	1939.04	2614.02	1371.58	2021.41	2725.75	1426.90	2103.81	2837.44
300	1364.48	2031.75	2754.88	1421.87	2118.08	2872.73	1479.27	2204.55	2990.59
320	1412.65	2124.44	2895.77	1472.13	2214.86	3019.78	1531.62	2305.28	3143.70
340	1460.87	2217.14	3036.71	1522.47	2311.60	3166.77	1584.02	2406.09	3296.87
360	1509.15	2309.89	3177.66	1572.80	2408.35	3313.85	1636.49	2506.86	3450.07
380	1557.31	2402.52	3318.54	1623.06	2505.09	3460.89	1688.81	2607.57	3603.24
400	1605.54	2495.25	3459.37	1673.41	2601.79	3607.89	1741.30	2708.34	3756.34

\*127mm louvre only

All prices shown exclude VAT



# Vertical Blinds

## SG 2950

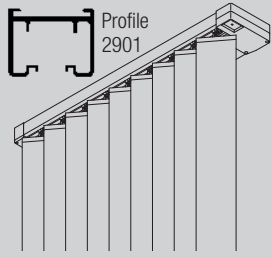

## SG 2900

Profile 2901 available in 6 metre lengths only. Headrail available in silver and white.

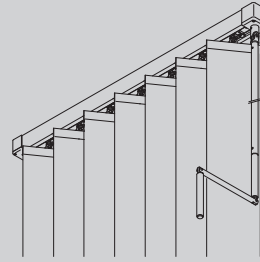

### SG 2950

#### Electrically Operated Vertical Blind System

Track system complete, assembled, ready to hang.

Min. system width: 110cm  
Max. system width: 600cm  
Available in 127mm and 89mm systems.  
Supplied with plug/socket 5741/5742 and recess switch 0565 for open/close/tilt operation. Silver or white at same cost.

### SG 2900

#### Track and Accessories only

Track system only complete, assembled, ready to hang.

Min. system width: 50cm  
Max. system width: 600cm

	Price Ctg.
Hardware only, no fabric. Excluding bottom weight and link cord but including 2605 top clips and 3033 top fix clamps. Operating handle 150cm drop as standard. Wall fixing brackets extra (see below). Prices given are for 127mm/5" louvres. Sloping window+50%. For 89mm/3 1/2" louvres, add 15%. Silver or white at same cost	<b>C</b>

	Price Ctg.
<b>*3D Vertical Waves</b> £360.50 set up charge. Please add to assembled prices. Made in Multi Visio Colour 1 127mm Andrea Design only.	<b>E</b>
<b>Printing Information</b> All RAL colours applicable (except white, pearl and fluorescent colours). Height 218cm to 297cm 5 shape louvre and 6 shape louvre.	

	Price Ctg.
<b>Pricing for SG 2950</b> Add to relevant hardware or hardware and fabric price over: 2950 £720.62 2950R £958.44 (Integrated Receiver)	<b>C</b>

Width up to cm	£	Width up to cm/ft.ins.	£	Width up to cm/ft.ins.	£
120	392.50	300	733.63	480	1074.74
140	430.41	320	771.53	500	1112.61
160	468.35	340	809.40	520	1150.54
180	506.26	360	847.36	540	1188.39
200	544.16	380	885.23	560	1226.37
220	582.05	400	923.14	580	1264.26
240	619.97	420	961.06	600	1302.15
260	657.89	440	998.94		
280	695.70	460	1036.81		

## Fabric price categories

For SG 2900 complete with fabrics (see tables over)

### Price Group 1

Element  
Function  
Multi Shadow  
Multi Visio

### Price Group 2

Alutex  
Colorama 2  
Mercurio B  
Multiscreen 5%  
Optiscreen 4%  
Versascreen 1%  
Versascreen 5%  
Versascreen 10%  
Vertical Wave (excl. sloping systems)

### Price Group 3

Colorama 2 Bioactive  
Moon  
Optiscreen 4% Alu  
Reflex  
3D Vertical Wave (Multi Visio)\*

All fabrics are available in 89mm and 127mm louvres (89mm add 15%).

All above fabrics are FR

	Price Ctg.
SG 0450 Radio Controls is also suitable for use with SG 2950.	<b>C</b>

	Price Ctg.
<b>Accessories</b> 2901 Profile, silver or white. 9117 Set. 2912 Belt. 2925 Belt connector. 2927 Pilot runner. 3033 Clamp. 9091 Motor	<b>C</b>

Bends	Max. trade discount	25%
Radius cm	Profile 2901	
50-99	£135.50	
Over 99	£257.50	

Colours	Price Ctg.
Other colours special order – see page 69.	<b>E</b>

Pricing Examples
2950 200cm width, straight hardware only: 2900 +per system £544.16 +£720.62 = £1264.78

Note: Price based on 127mm/5" system.

	Price Ctg.
<b>Accessories</b> 2605 Top clip 127mm each, white. 2813 Top clip 89mm each, white. 2735 Nylon weight hook, each, 100. 2746 Detachable crank handle (standard). 2824 Endstop, each, 10. 2471 Bottom weight 127mm. 2473 Bottom weight 89mm. 2479 Bottom link cord 127mm. 2481 Bottom link cord 89mm. 2901 Profile, per metre. 2912 Drive belt. 2916 Rotation element 127 mm. 2918 Rotation element 89mm. 2920 Endpiece set, white or grey. 2925 Belt Connector. 2927 Pilot runner, each 3033 Clamps set of 10, 100. 2849 Top clip for PVC per 100. 2962 Connecting bridge. 6268 Hanger bracket for recess profile 2948. 6952 Magnetic handle holder.	<b>C</b>

	Price Ctg.
2671 Bottom weight 89mm without horns. 2672 Bottom weight 127mm without horns. 1148C Screw 31mm/1 1/4" No. 8 counter sunk, 100.	<b>A</b>

Universal Smart Fix Extension Bracket in white or silver
11154 Universal Smart Fix 120mm.
11155 Universal Smart Fix 150mm.
11156 Universal Smart Fix 200mm.

	Price Ctg.
<b>Colours</b> Other colours special order – see page 73.	<b>E</b>

Bends	Max trade discount	25%
Radius/cm	Profile 2901	
50-99	£135.50	
Over 99	£257.50	

N.B.
For guidance the following number of louvres per metre should be calculated: 89mm : 13/metre 127mm : 10/metre

All prices shown exclude VAT



# SG 2900 complete with fabric

The prices below comprise complete system, silver or white ready-to-hang, top fix, single or pair stack with fabric choice in 127mm/5" louvres (see fabric price categories). Includes bottom weights and bottom link cord to both sides, 150cm drop operating crank handle. Wall fix brackets extra. For 89mm/3 1/2" louvres add 15%. If sizes lie between the measurements shown, the price for the next larger size will apply. Set up costs apply for 3D vertical wavs.

Price Category C

Width cm	UP TO 120			UP TO 140			UP TO 160		
	1	2	3	1	2	3	1	2	3
Drop cm									
60	498.19	532.99	570.75	546.94	587.55	631.60	595.65	642.04	692.39
80	510.80	557.17	607.49	561.60	615.72	674.50	612.42	674.27	741.38
100	523.34	581.44	644.28	576.32	643.96	717.37	629.18	706.58	790.42
120	535.95	605.55	680.95	590.94	672.16	760.21	645.94	738.82	839.43
140	548.48	629.76	717.82	605.59	700.38	803.09	662.71	771.05	888.42
160	561.07	653.92	754.53	620.28	728.62	845.96	679.49	803.27	937.37
180	573.66	678.11	791.28	635.00	756.81	888.91	696.27	835.53	986.42
200	586.23	702.31	828.07	649.62	785.07	931.75	713.01	867.74	1035.41
220	598.85	726.41	864.79	664.34	813.26	974.61	729.82	900.03	1084.45
240	611.41	750.60	901.58	678.95	841.42	1017.52	746.60	932.26	1133.47
260	623.92	774.86	938.30	693.62	869.66	1060.40	763.34	964.50	1182.49
280	636.54	799.02	975.10	708.31	897.84	1103.26	780.10	996.74	1231.51
300	649.14	823.23	1011.85	722.97	926.09	1146.17	796.82	1028.96	1280.45
320	661.71	847.37	1048.59	737.67	954.32	1189.03	813.63	1061.18	1329.51
340	674.25	871.56	1085.37	752.35	982.48	1231.92	830.42	1093.51	1378.51
360	686.82	895.74	1122.11	767.01	1010.75	1274.81	847.16	1125.72	1427.51
380	699.44	919.89	1158.87	781.69	1038.89	1317.71	863.95	1157.97	1476.56
400	712.02	944.09	1195.61	796.35	1067.15	1360.62	880.73	1190.17	1525.52

Width cm	UP TO 180			UP TO 200			UP TO 220		
	1	2	3	1	2	3	1	2	3
Drop cm									
60	644.38	696.61	753.17	693.14	751.11	814.00	741.81	805.66	874.80
80	663.21	732.88	808.29	714.06	791.42	875.34	764.89	850.02	942.17
100	682.06	769.15	863.46	734.98	831.70	936.49	787.92	894.32	1009.60
120	700.98	805.37	918.58	755.97	872.03	997.79	810.99	938.62	1077.00
140	719.83	841.69	973.74	776.94	912.30	1059.06	834.04	983.00	1144.38
160	738.67	877.94	1028.87	797.91	952.65	1120.33	857.06	1027.29	1211.72
180	757.54	914.24	1084.02	818.87	992.95	1181.57	880.16	1071.67	1279.12
200	776.43	950.49	1139.13	839.85	1033.21	1242.85	903.19	1115.96	1346.53
220	795.31	986.76	1194.25	860.80	1073.56	1304.11	926.26	1160.31	1413.91
240	814.15	1023.06	1249.43	881.75	1113.82	1365.37	949.32	1204.63	1481.28
260	833.02	1059.29	1304.53	902.70	1154.18	1426.59	972.42	1248.96	1548.72
280	851.84	1095.57	1359.70	923.65	1194.44	1487.89	995.45	1293.29	1616.06
300	870.77	1131.86	1414.84	944.60	1234.73	1549.13	1018.48	1337.60	1683.50
320	889.62	1168.15	1469.96	965.58	1275.07	1610.41	1041.57	1381.92	1750.90
340	908.47	1204.42	1525.07	986.52	1315.35	1671.65	1064.62	1426.28	1818.26
360	927.34	1240.71	1580.23	1007.52	1355.64	1732.93	1087.68	1470.62	1885.63
380	946.23	1276.94	1635.36	1028.50	1395.94	1794.19	1110.73	1514.91	1953.01
400	965.01	1313.20	1690.52	1049.44	1436.24	1855.45	1133.75	1559.28	2020.43

Width cm	UP TO 240			UP TO 260			UP TO 280		
	1	2	3	1	2	3	1	2	3
Drop cm									
60	790.55	860.18	935.66	839.26	914.68	996.42	887.99	969.22	1057.25
80	815.69	908.49	1009.17	866.50	967.07	1076.06	917.30	1025.60	1142.99
100	840.85	956.88	1082.63	893.75	1019.45	1155.72	946.67	1082.07	1228.79
120	866.01	1005.26	1156.14	921.00	1071.84	1235.37	976.03	1138.50	1314.57
140	891.09	1053.61	1229.69	948.26	1124.28	1315.01	1005.37	1194.90	1400.33
160	916.30	1101.95	1303.21	975.48	1176.67	1394.67	1034.70	1251.33	1486.07
180	941.46	1150.36	1376.71	1002.76	1229.05	1474.26	1064.02	1307.76	1571.87
200	966.60	1198.71	1450.28	1030.00	1281.40	1553.92	1093.40	1364.19	1657.60
220	991.77	1247.05	1523.70	1057.25	1333.83	1633.62	1122.79	1420.57	1743.41
240	1016.86	1295.38	1597.22	1084.48	1386.23	1713.18	1152.11	1477.01	1829.15
260	1042.05	1343.81	1670.77	1111.74	1438.62	1792.90	1181.44	1533.46	1914.93
280	1067.22	1392.14	1744.25	1139.00	1491.01	1872.49	1210.77	1589.81	2000.71
300	1092.36	1440.56	1817.82	1166.23	1543.39	1952.11	1240.10	1646.29	2086.44
320	1117.55	1488.87	1891.33	1193.48	1595.77	2031.77	1269.49	1702.71	2172.26
340	1142.64	1537.24	1964.83	1220.76	1648.21	2111.39	1298.84	1759.16	2257.95
360	1167.83	1585.61	2038.32	1248.01	1700.60	2191.05	1328.16	1815.54	2343.77
380	1192.96	1634.00	2111.81	1275.20	1752.99	2270.67	1357.50	1871.95	2429.51
400	1218.10	1682.33	2185.36	1302.49	1805.35	2350.28	1386.82	1928.39	2515.28

All prices shown exclude VAT





# SG 2900 complete with fabric

The prices below comprise complete system, silver or white ready-to-hang, top fix, single or pair stack with fabric choice in 127mm/5" louvres (see fabric price categories). Includes bottom weights and bottom link cord to both sides, 150cm drop operating crank handle. Wall fix brackets extra. For 89mm/3 1/2" louvres add 15%. If sizes lie between the measurements shown, the price for the next larger size will apply. Set up costs apply for 3D vertical waves.

Price Category C

Width	UP TO 300			UP TO 320			UP TO 340		
	1	2	3	1	2	3	1	2	3
Drop cm									
60	936.72	1023.74	1118.03	985.42	1078.23	1178.89	1034.17	1132.77	1239.69
80	968.12	1084.23	1209.96	1018.97	1142.73	1276.87	1069.79	1201.26	1343.86
100	999.57	1144.67	1301.85	1052.48	1207.23	1374.94	1105.44	1269.83	1447.98
120	1031.00	1205.10	1393.70	1086.05	1271.69	1472.94	1141.05	1338.29	1552.13
140	1062.43	1265.58	1485.68	1119.58	1336.17	1570.98	1176.68	1406.88	1656.24
160	1093.91	1326.01	1577.53	1153.10	1400.66	1668.93	1212.31	1475.36	1760.38
180	1125.35	1386.45	1669.44	1186.66	1465.18	1766.97	1247.93	1543.88	1864.56
200	1156.77	1446.90	1761.30	1220.22	1529.62	1865.01	1283.58	1612.41	1968.69
220	1188.21	1507.36	1853.19	1253.73	1594.13	1963.04	1319.22	1680.88	2072.86
240	1219.67	1567.77	1945.13	1287.26	1658.61	2061.06	1354.84	1749.39	2177.00
260	1251.10	1628.23	2036.99	1320.75	1723.08	2159.06	1390.47	1817.92	2281.16
280	1282.57	1688.74	2128.91	1354.33	1787.59	2257.08	1426.12	1886.40	2385.32
300	1313.99	1749.18	2220.79	1387.86	1852.08	2355.13	1461.77	1954.98	2489.43
320	1345.46	1809.62	2312.65	1421.43	1916.56	2453.09	1497.37	2023.45	2593.58
340	1376.86	1870.09	2404.56	1454.96	1981.02	2551.12	1532.96	2091.95	2697.70
360	1408.34	1930.51	2496.46	1488.45	2045.53	2649.15	1568.64	2160.50	2801.86
380	1439.73	1990.98	2588.34	1522.02	2109.99	2747.21	1604.27	2228.99	2905.99
400	1471.22	2051.42	2680.21	1555.56	2174.53	2845.24	1639.91	2297.51	3010.15

Width	UP TO 360			UP TO 380			UP TO 400		
	1	2	3	1	2	3	1	2	3
Drop cm									
60	1082.86	1187.29	1300.48	1131.62	1241.84	1361.33	1180.29	1296.35	1422.15
80	1120.60	1259.88	1410.77	1171.44	1318.40	1477.68	1222.23	1376.96	1544.65
100	1158.33	1332.42	1521.02	1211.26	1394.98	1594.12	1264.11	1457.58	1667.18
120	1196.04	1404.94	1631.34	1251.08	1471.54	1710.50	1306.06	1538.16	1789.69
140	1233.82	1477.50	1741.61	1290.92	1548.13	1826.87	1348.00	1618.74	1912.21
160	1271.50	1550.05	1851.84	1330.71	1624.68	1943.26	1389.94	1699.40	2034.75
180	1309.22	1622.55	1962.12	1370.53	1701.28	2059.70	1431.82	1779.96	2157.27
200	1346.92	1695.11	2072.38	1410.36	1777.84	2176.07	1473.78	1860.58	2279.80
220	1384.73	1767.63	2182.66	1450.21	1854.45	2292.51	1515.67	1941.20	2402.32
240	1422.41	1840.25	2292.98	1490.01	1930.99	2408.85	1557.60	2021.79	2524.82
260	1460.16	1912.74	2403.24	1529.87	2007.55	2525.31	1599.53	2102.39	2647.37
280	1497.88	1985.26	2513.47	1569.65	2084.14	2641.73	1641.46	2182.96	2769.88
300	1535.61	2057.82	2623.77	1609.50	2160.70	2758.07	1683.37	2263.59	2892.35
320	1573.35	2130.39	2734.06	1649.30	2237.26	2874.53	1725.29	2344.23	3014.95
340	1611.08	2202.95	2844.30	1689.15	2313.85	2990.87	1767.20	2424.82	3137.44
360	1648.78	2275.46	2954.60	1728.97	2390.45	3107.26	1809.13	2505.38	3260.00
380	1686.52	2348.00	3064.82	1768.75	2466.97	3223.65	1851.02	2585.98	3382.54
400	1724.27	2420.54	3175.12	1808.62	2543.60	3340.07	1892.95	2666.59	3505.08

Width	UP TO 420			UP TO 440			UP TO 460		
	1	2	3	1	2	3	1	2	3
Drop cm									
60	1229.04	1350.87	1482.93	1277.81	1405.42	1543.72	1326.48	1459.89	1604.55
80	1273.04	1435.52	1611.60	1323.88	1494.05	1678.54	1374.71	1552.67	1745.42
100	1317.06	1520.13	1740.25	1369.99	1582.72	1813.34	1422.85	1645.35	1886.36
120	1361.09	1604.81	1868.91	1416.14	1671.36	1948.08	1471.08	1738.03	2027.29
140	1405.10	1689.42	1997.55	1462.21	1760.06	2082.90	1519.34	1830.71	2168.16
160	1449.13	1774.02	2126.19	1508.33	1848.73	2217.64	1567.54	1923.39	2309.10
180	1493.14	1858.69	2254.82	1554.41	1937.39	2352.45	1615.75	2016.11	2449.98
200	1537.15	1943.27	2383.47	1600.56	2026.07	2487.18	1663.94	2108.79	2590.88
220	1581.19	2027.98	2512.14	1646.71	2114.71	2621.98	1712.15	2201.52	2731.80
240	1625.19	2112.56	2640.80	1692.76	2203.38	2756.73	1760.36	2294.13	2872.70
260	1669.22	2197.25	2769.40	1738.91	2292.04	2891.50	1808.57	2386.88	3013.58
280	1713.21	2281.86	2898.07	1784.98	2380.69	3026.30	1856.78	2479.57	3154.48
300	1757.23	2366.51	3026.76	1831.12	2469.36	3161.10	1905.02	2572.27	3295.37
320	1801.26	2451.12	3155.37	1877.24	2558.01	3295.84	1953.18	2664.98	3436.32
340	1845.25	2535.75	3284.07	1923.31	2646.66	3430.59	2001.42	2757.66	3577.21
360	1889.24	2620.34	3412.69	1969.44	2735.37	3565.41	2049.59	2850.31	3718.12
380	1933.32	2705.01	3541.38	2015.57	2824.02	3700.20	2097.80	2943.07	3859.01
400	1977.33	2789.67	3670.02	2061.67	2912.71	3834.97	2146.04	3035.70	3999.94

All prices shown exclude VAT



# SG 2900 complete with fabric

The prices below comprise complete system, silver or white ready-to-hang, top fix, single or pair stack with fabric choice in 127mm/5" louvres (see fabric price categories). Includes bottom weights and bottom link cord to both sides, 150cm drop operating crank handle. Wall fix brackets extra. For 89mm/3 1/2" louvres add 15%. If sizes lie between the measurements shown, the price for the next larger size will apply. Set up costs apply for 3D vertical waves.

Price Category C

Width cm	UP TO 480			UP TO 500			UP TO 520		
	1	2	3	1	2	3	1	2	3
Drop cm									
60	1375.23	1514.50	1665.42	1423.87	1568.98	1726.22	1472.60	1623.50	1786.94
80	1425.53	1611.17	1812.42	1476.30	1669.68	1879.33	1527.17	1728.31	1946.28
100	1475.83	1707.93	1959.39	1528.68	1770.50	2032.49	1581.62	1833.07	2105.56
120	1526.11	1804.64	2106.48	1581.15	1871.22	2185.66	1636.14	1937.84	2264.87
140	1576.43	1901.36	2253.48	1633.53	1972.01	2338.83	1690.63	2042.68	2424.16
160	1626.75	1998.10	2400.50	1685.90	2072.78	2491.94	1745.13	2147.41	2583.45
180	1677.00	2094.80	2547.56	1738.32	2173.53	2645.10	1799.63	2252.23	2742.69
200	1727.34	2191.47	2694.56	1790.70	2274.29	2798.24	1854.11	2357.00	2901.99
220	1777.64	2288.25	2841.62	1843.17	2375.00	2951.42	1908.62	2461.78	3061.23
240	1827.94	2384.98	2988.64	1895.56	2475.81	3104.57	1963.12	2566.57	3220.52
260	1878.28	2481.69	3135.68	1947.93	2576.49	3257.73	2017.61	2671.37	3379.80
280	1928.52	2578.42	3282.70	2000.32	2677.27	3410.87	2072.14	2776.17	3539.07
300	1978.87	2675.15	3429.71	2052.73	2778.03	3564.04	2126.62	2880.92	3698.34
320	2029.19	2771.88	3576.78	2105.16	2878.77	3717.26	2181.12	2985.70	3857.69
340	2079.48	2868.59	3723.76	2157.55	2979.52	3870.35	2235.63	3090.50	4016.92
360	2129.80	2965.35	3870.85	2209.95	3080.33	4023.52	2290.12	3195.30	4176.19
380	2180.09	3062.03	4017.87	2262.32	3181.04	4176.65	2344.63	3300.07	4335.47
400	2230.36	3158.75	4164.88	2314.71	3281.85	4329.86	2399.10	3404.85	4494.80

Width cm	UP TO 540			UP TO 560			UP TO 580		
	1	2	3	1	2	3	1	2	3
Drop cm									
60	1521.36	1678.05	1847.82	1570.06	1732.53	1908.62	1618.82	1787.09	1969.41
80	1577.95	1786.85	2013.25	1628.78	1845.43	2080.15	1679.55	1903.96	2147.13
100	1634.56	1895.67	2178.64	1687.48	1958.26	2251.67	1740.40	2020.79	2324.72
120	1691.18	2004.44	2344.02	1746.14	2071.05	2423.21	1801.17	2137.74	2502.43
140	1747.71	2113.27	2509.43	1804.86	2183.94	2594.78	1861.96	2254.56	2680.05
160	1804.33	2222.11	2674.86	1863.55	2296.79	2766.29	1922.75	2371.44	2857.72
180	1860.91	2330.90	2840.28	1922.22	2409.64	2937.82	1983.46	2488.35	3035.42
200	1917.55	2439.74	3005.67	1980.90	2522.44	3109.33	2044.29	2605.19	3212.99
220	1974.10	2548.58	3171.04	2039.62	2635.30	3280.95	2105.11	2722.10	3390.73
240	2030.70	2657.37	3336.48	2098.29	2748.17	3452.42	2165.89	2838.97	3568.33
260	2087.31	2766.19	3501.86	2156.98	2861.00	3623.96	2226.67	2955.85	3746.06
280	2143.90	2874.99	3667.30	2215.71	2973.89	3795.48	2287.43	3072.71	3923.73
300	2200.47	2983.82	3832.75	2274.34	3086.62	3967.08	2348.20	3189.60	4101.36
320	2257.08	3092.61	3998.09	2333.09	3199.57	4138.55	2409.03	3306.42	4279.07
340	2313.66	3201.43	4163.53	2391.72	3312.37	4310.11	2469.83	3423.32	4456.69
360	2370.27	3310.26	4328.90	2450.44	3425.22	4481.63	2530.61	3540.21	4634.35
380	2426.81	3419.06	4494.34	2509.09	3538.06	4653.19	2591.39	3657.06	4812.01
400	2483.42	3527.91	4659.76	2567.79	3650.91	4824.68	2652.12	3773.94	4989.69

Width cm	UP TO 600		
	1	2	3
Drop cm			
60	1667.50	1841.61	2030.21
80	1730.38	1962.50	2214.02
100	1793.30	2083.45	2397.85
120	1856.14	2204.30	2581.63
140	1919.05	2325.24	2765.42
160	1981.97	2446.16	2949.18
180	2044.88	2567.07	3132.92
200	2107.76	2687.95	3316.76
220	2170.61	2808.83	3500.56
240	2233.49	2929.76	3684.33
260	2296.39	3050.66	3868.09
280	2359.26	3171.57	4051.94
300	2422.11	3292.49	4235.68
320	2485.02	3413.36	4419.44
340	2547.89	3534.27	4603.29
360	2610.75	3655.21	4787.06
380	2673.60	3776.10	4970.83
400	2736.49	3897.02	5154.60

All prices shown exclude VAT



# Roller Blinds

## SG 4900

Spring operation with decelerator.  
Tube diameter 32.2mm

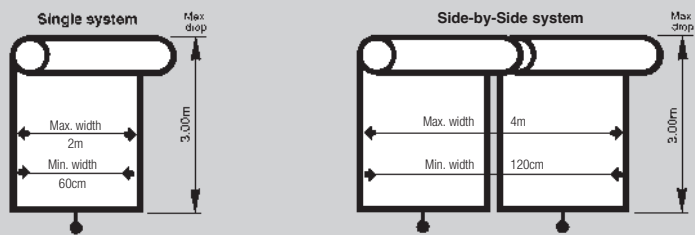

### System 4900 complete with fabric

The prices below comprise the complete system made-to-measure, ready-to-hang with fabric of your choice. Operation as standard with pull-ball. Please consult application chart (page 56 of our main price list) to ensure that fabric chosen can be supplied in dimensions required.

Price category C

#### Price Group 1R

Basic Screen 5%  
Colorama 1  
Colorama 1 Alu  
Element  
Puma

Width	60cm	80cm	100cm	120cm	140cm	160cm	180cm	200cm	Width
Drop									Drop
60	242.68	256.61	270.57	284.56	298.46	312.49	326.39	340.35	60
80	247.50	263.04	278.62	294.11	309.69	325.25	340.83	356.32	80
100	252.27	269.45	286.59	303.78	320.87	338.04	355.21	372.40	100
120	257.08	275.83	294.58	313.38	332.06	350.89	369.62	388.39	120
140	261.87	282.22	302.58	322.96	343.27	363.65	383.99	404.39	140
160	266.66	288.62	310.57	332.57	354.51	376.44	398.43	420.39	160
180	271.45	295.05	318.62	342.16	365.72	389.29	412.87	436.32	180
200	276.36	301.40	326.59	351.77	376.86	402.09	427.21	452.40	200
220	281.10	307.88	334.63	361.31	388.08	414.86	441.64	468.37	220
240	285.90	314.27	342.59	370.98	399.31	427.69	456.04	484.38	240
260	290.67	320.67	350.61	380.55	410.56	440.46	470.48	500.48	260
280	295.50	327.04	358.59	390.11	421.77	453.28	484.84	516.38	280
300	300.28	333.48	366.58	399.73	432.95	466.09	499.25	532.40	300

#### Price Group 2R

Alutex  
Colorama 2  
Colorama 2 Alu  
Colorama 2 Bioactive  
Dualscreen 3%  
Dualscreen 5%  
Mercurio B  
Multi Shadow  
Multi Visio  
Multiscreen 5%  
Multiscreen 10%  
Newlife Screen  
Nox

Optiscreen  
Silente 20  
Slimscreen  
Versascreen 5%  
Versascreen 10%

Width	60cm	80cm	100cm	120cm	140cm	160cm	180cm	200cm	Width
Drop									Drop
60	251.84	268.82	285.78	302.81	319.84	336.80	353.82	370.79	60
80	259.63	279.27	298.89	318.52	338.12	357.70	377.32	396.95	80
100	267.52	289.72	311.98	334.16	356.37	378.64	400.87	423.09	100
120	275.34	300.20	325.05	349.93	374.76	399.55	424.40	449.26	120
140	283.20	310.65	338.12	365.57	393.05	420.52	447.96	475.39	140
160	291.07	321.13	351.15	381.28	411.36	441.43	471.46	501.55	160
180	298.89	331.53	364.23	396.95	429.70	462.37	495.02	527.71	180
200	306.72	342.01	377.32	412.63	447.96	483.23	518.54	553.89	200
220	314.56	352.47	390.38	428.33	466.26	504.16	542.07	580.03	220
240	322.44	362.91	403.53	444.01	484.57	525.08	565.65	606.21	240
260	330.29	373.43	416.56	459.71	502.86	545.99	589.15	632.28	260
280	338.12	383.89	429.70	475.39	521.13	566.93	612.69	658.45	280
300	345.98	394.31	442.72	491.09	539.47	587.83	636.22	684.62	300

#### Price Group 3R

Aluscreen Futura  
Deep  
Ecoscreen  
Lightscreen  
Linea  
Linea Alu  
Moon  
Newlife 1  
Newlife 2  
Newlife Screen Alu  
Reflex  
Safescreen  
Silente 10

Width	60cm	80cm	100cm	120cm	140cm	160cm	180cm	200cm	Width
Drop									Drop
60	271.55	295.19	318.69	342.28	365.88	389.49	413.01	436.66	60
80	285.99	314.37	342.76	371.18	399.59	427.95	456.39	484.73	80
100	300.40	333.65	366.87	400.07	433.24	466.43	499.67	532.84	100
120	314.88	352.87	390.87	428.91	466.90	504.91	542.97	580.95	120
140	329.30	372.08	414.93	457.77	500.59	543.44	586.21	629.04	140
160	343.69	391.34	439.04	486.60	534.23	581.87	629.56	677.16	160
180	358.13	410.59	463.06	515.46	567.93	620.38	672.78	725.26	180
200	372.59	429.82	487.08	544.36	601.59	658.83	716.09	773.39	200
220	386.98	449.07	511.17	573.21	635.23	697.33	759.41	821.45	220
240	401.46	468.31	535.22	602.05	668.89	735.78	802.67	869.58	240
260	415.84	487.53	559.20	630.93	702.59	774.31	845.96	917.63	260
280	430.29	506.79	583.28	659.80	736.24	812.77	889.28	965.75	280
300	444.69	526.03	607.36	688.64	769.95	851.30	932.56	1013.85	300

### SG 4900 – Hardware only

Supplied ready-assembled incl. adhesive tape for customers to mount own fabrics. Bottom bar not incl. – see page 52 of our main price list.

Side-guide wire option is available at an additional cost of £48.13.

For optional stop controller add £17.30.

Spring	Width of blind up to								Price category C
Clutch	60cm	80cm	100cm	120cm	140cm	160cm	180cm	200cm	
4212/3 A/B	196.15	199.74	203.35	206.97	210.56	214.17	217.77	221.36	
4214/5 C/D	227.01	230.78	234.53	238.29	241.99	249.49	253.26	256.95	
4216/7 E/F	233.44	237.13	240.86	244.59	248.25	251.97	255.69	259.42	

Consult Silent Gliss to determine spring type required.

### Continuous Headrail

Provides an alternative to fitting to the wall or ceiling, supplied made to measure in silver or white (other custom colours available, pricing as per page 73 of our main price list), for use on 4900, 4910, 4930, 4960 and 4970. £27.97 per m add on.

### SG 4900 – Side-by-Side System

Simply price as two separate systems stating side-by-side.



# Roller Blinds

## Laminated Blinds (Customer's own material for Roller Blinds)

Supply your own fabric, we will provide the laminating service. Prices below include for hardware systems 4900/4910. Sewn-in bottom bar supplied as standard (Trim 16). Our laminate will usually be supplied in cream as standard.

Please send a flat sample of customer's own material (1m<sup>2</sup> minimum) so that Silent Gliss can confirm suitability for laminating. All fabrics must be approved prior to ordering.

Price category C

Width cm	System	100	120	140	160	170	180	200	220	230
Drop cm										
90		361.80	390.29	418.89	447.35	475.84	765.92	778.04	837.55	852.31
120		402.21	438.77	475.49	512.07	548.59	799.10	828.06	877.04	920.76
150	4900/	442.66	487.28	532.16	576.74	621.36	876.49	922.84	969.19	1081.36
180	4910/	483.09	535.79	588.76	641.43	694.13	929.15	1038.68	1085.03	1184.03
210	(4960 electric)	523.47	584.32	645.34	706.14	766.92	1042.35			
240		563.82	632.65	701.77	770.61	839.46	1100.27			
270		702.12	780.31	858.87	937.06	1015.21	1218.74			
300		742.52	828.82	917.46	1005.60	1096.29				

Prices in this table are for spring or chain operation. For electric (4960) add £556.30.

### Flame Retardant (FR) Laminate

Add 20% to prices shown above. FR laminate available in white or cream.

### Blackout Laminate

Add 20% to prices shown above. Blackout laminate available in white or cream.

### Decorative Trims

Price on request.



# Roller Blinds

## SG 4907

Chain operated roller blinds.  
Tube diameter 32.2mm

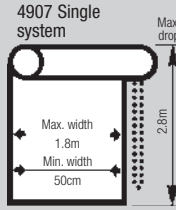

### SG 4907 complete with fabric

The prices below comprise the complete system made-to-measure, ready-to-hang with fabric of your choice. Please consult application chart (page 56) to ensure that fabric desired can be supplied in dimensions required.

Price category C

#### Price Group 1R

Colorama 1  
Colorama 1 Alu  
Element  
**Puma**  
**Basic Screen 5%**  
**Basic Screen 10%**

Width	60cm	80cm	100cm	120cm	140cm	160cm	180cm	Width
Drop cm								Drop cm
60	218.41	230.96	243.51	256.11	268.62	281.23	293.75	60
80	222.75	236.72	250.75	264.71	278.72	292.72	306.74	80
100	227.05	242.50	257.91	273.40	288.79	304.25	319.70	100
120	231.37	248.25	265.12	282.03	298.86	315.81	332.65	120
140	235.68	254.00	272.33	290.66	308.95	327.29	345.60	140
160	239.99	259.76	279.51	299.32	319.06	338.80	358.58	160
180	244.32	265.54	286.76	307.93	329.16	350.36	371.58	180
200	248.71	271.26	293.94	316.59	339.18	361.87	384.50	200
220	252.98	277.09	301.16	325.18	349.27	373.38	397.48	220
240	257.31	282.85	308.34	333.90	359.37	384.93	410.44	240
260	261.60	288.60	315.54	342.52	369.50	396.42	423.42	260
280	265.95	294.34	322.73	351.10	379.59	407.94	436.34	280

#### Price Group 2R

Basic Screen 1%  
Alutex  
Colorama 2  
Colorama 2 Alu  
Colorama 2 Bioactive  
**Dualscreen 3%**  
**Dualscreen 5%**  
Mercurio B  
Multi Shadow  
Multi Visio  
**Multiscreen 1%**  
**Multiscreen 5%**  
**Multiscreen 10%**

Newlife Screen  
Nox  
Optiscreen  
Silente 20  
Slimscreen  
**Versascreen 1%**  
**Versascreen 5%**  
**Versascreen 10%**

Width	60cm	80cm	100cm	120cm	140cm	160cm	180cm	Width
Drop cm								Drop cm
60	226.65	241.95	257.21	272.53	287.84	303.12	318.42	60
80	233.68	251.35	269.01	286.67	304.31	321.92	339.59	80
100	240.76	260.75	280.77	300.74	320.73	340.77	360.79	100
120	247.81	270.18	292.55	314.93	337.27	359.60	381.95	120
140	254.87	279.59	304.31	329.01	353.74	378.46	403.16	140
160	261.95	289.02	316.05	343.13	370.22	397.27	424.30	160
180	269.01	298.36	327.81	357.26	386.72	416.13	445.53	180
200	276.03	307.79	339.59	371.37	403.16	434.91	466.69	200
220	283.11	317.22	351.34	385.49	419.63	453.76	487.87	220
240	290.19	326.62	363.17	399.59	436.11	472.57	509.09	240
260	297.28	336.09	374.91	413.76	452.56	491.40	530.23	260
280	304.31	345.49	386.72	427.85	469.01	510.24	551.40	280

#### Price Group 3R

Aluscreen Futura  
Deep  
Ecoscreen  
Jumbotex  
Lightscreen  
Linea  
Linea Alu  
Moon  
Newlife 1  
Newlife 2  
Newlife Screen Alu

Reflex  
Safescreen  
Silente 10  
Twin Blackout  
Umbrascreen

Width	60cm	80cm	100cm	120cm	140cm	160cm	180cm	Width
Drop cm								Drop cm
60	244.40	265.67	286.82	308.06	329.27	350.54	371.72	60
80	257.40	282.94	308.49	334.08	359.66	385.16	410.76	80
100	270.36	300.28	330.19	360.07	389.91	419.80	449.71	100
120	283.40	317.57	351.79	386.02	420.22	454.43	488.68	120
140	296.38	334.86	373.45	412.00	450.54	489.11	527.60	140
160	309.32	352.20	395.14	437.95	480.82	523.68	566.60	160
180	322.31	369.53	416.75	463.92	511.14	558.33	605.51	180
200	335.32	386.83	438.38	489.91	541.44	592.94	644.47	200
220	348.28	404.17	460.06	515.90	571.71	627.60	683.47	220
240	361.31	421.49	481.69	541.84	602.00	662.21	722.41	240
260	374.26	438.77	503.29	567.84	632.33	696.88	761.35	260
280	387.25	456.11	524.95	593.82	662.61	731.50	800.35	280

#### SG 4907 – Side-by-Side System

There is no add-on. Simply order two systems, stating side-by-side.

#### SG 4907 – Hardware only

Supplied ready-assembled incl. adhesive tape for customers to mount own fabrics.

Width of blind up to

60cm	80cm	100cm	120cm	140cm	160cm	180cm
204.31	207.70	211.07	214.47	217.79	224.54	227.94

#### Continuous Headrail

Provides an alternative to fitting to the wall or ceiling, supplied made to measure in silver or white (other custom colours available, pricing as per page 73), for use on 4900, 4910, 4930, 4960 and 4970. £27.97 per m add on.

All prices shown exclude VAT





# Roller Blinds

## SG 4910

Chain operated roller blinds.  
Tube diameter 41mm

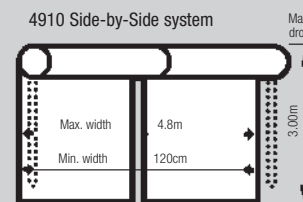
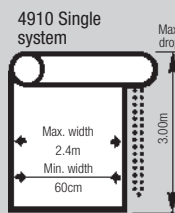

### SG 4910 complete with fabric

The prices below comprise the complete system made-to-measure, ready-to-hang with fabric of your choice. Please consult application chart (page 56) to ensure that fabric desired can be supplied in dimensions required. Stainless steel operating chain supplied as standard (brass chain also available at no additional cost).

Price category C

#### Price Group 1R

- Colorama 1
- Colorama 1 Alu
- Element
- Puma**
- Basic Screen 5%**
- Basic Screen 10%**

Width	60cm	80cm	100cm	120cm	140cm	160cm	180cm	200cm	220cm	230cm	240cm	Width
Drop cm												Drop cm
60	242.68	256.61	270.57	284.56	298.46	312.49	326.39	340.35	354.30	361.27	368.28	60
80	247.50	263.04	278.62	294.11	309.69	325.25	340.83	356.32	371.90	379.70	387.49	80
100	252.27	269.45	286.59	303.78	320.87	338.04	355.21	372.40	387.56	395.16	402.74	100
120	257.08	275.83	294.58	313.38	332.06	350.89	369.62	388.39	407.13	416.51	425.87	120
140	261.87	282.22	302.58	322.96	343.27	363.65	383.99	404.39	424.72	434.93	445.05	140
160	266.66	288.62	310.57	332.57	354.51	376.44	398.43	420.39	442.39	453.41	464.38	160
180	271.45	295.05	318.62	342.16	365.72	389.29	412.87	436.32	459.88	471.69	483.42	180
200	276.36	301.40	326.59	351.77	376.86	402.09	427.21	452.40	477.54	490.09	502.64	200
220	281.10	307.88	334.63	361.31	388.08	414.86	441.64	468.37	495.18	508.53	521.95	220
240	285.90	314.27	342.59	370.98	399.31	427.69	456.04	484.38	512.71	526.91	541.05	240
260	290.67	320.67	350.61	380.55	410.56	440.46	470.48	500.48	530.38	545.35	560.30	260
280	295.50	327.04	358.59	390.11	421.77	453.28	484.84	516.38	547.92	563.67	579.44	280
300	300.28	333.48	366.58	399.73	432.95	466.09	499.25	532.40	565.56	582.13	598.74	300

#### Price Group 2R

- Alutex
- Basic Screen 1%
- Colorama 2
- Colorama 2 Alu
- Colorama 2 Bioactive
- Dualscreen 1%**
- Dualscreen 3%**
- Dualscreen 5%**
- Mercurio B
- Multi Shadow
- Multi Visio
- Multiscreen 1%**
- Multiscreen 5%**
- Multiscreen 10%**
- Newlife Screen
- Nox
- Optiscreen
- Silente 20
- Silmscreen
- Versascreen 1%**
- Versascreen 5%**
- Versascreen 10%**

Width	60cm	80cm	100cm	120cm	140cm	160cm	180cm	200cm	220cm	230cm	240cm	Width
Drop cm												Drop cm
60	251.84	268.82	285.78	302.81	319.84	336.80	353.82	370.79	387.75	396.26	404.77	60
80	259.63	279.27	298.89	318.52	338.12	357.70	377.32	396.95	416.56	426.41	436.19	80
100	267.52	289.72	311.98	334.16	356.37	378.64	400.87	423.09	445.29	456.42	467.50	100
120	275.34	300.20	325.05	349.93	374.76	399.55	424.40	449.26	474.15	486.57	499.02	120
140	283.20	310.65	338.12	365.57	393.05	420.52	447.96	475.39	502.86	516.61	530.32	140
160	291.07	321.13	351.15	381.28	411.36	441.43	471.46	501.55	531.62	546.62	561.67	160
180	298.89	331.53	364.23	396.95	429.70	462.37	495.02	527.71	560.41	576.77	593.13	180
200	306.72	342.01	377.32	412.63	447.96	483.23	518.54	553.89	589.16	606.83	624.46	200
220	314.56	352.47	390.38	428.33	466.26	504.16	542.07	580.03	617.94	636.91	655.82	220
240	322.44	362.91	403.53	444.01	484.57	525.08	565.65	606.21	646.72	667.00	687.22	240
260	330.29	373.43	416.56	459.71	502.86	545.99	589.15	632.28	675.46	697.03	718.67	260
280	338.12	383.89	429.70	475.39	521.13	566.93	612.69	658.45	704.19	727.06	749.91	280
300	345.98	394.31	442.72	491.09	539.47	587.83	636.22	684.62	732.98	757.19	781.35	300

#### Price Group 3R

- Aluscreen Futura
- Deep
- Ecosecure
- Jumbotex
- Lightscreen
- Linea
- Linea Alu
- Moon
- Newlife 1
- Newlife 2
- Newlife Screen Alu
- Optiscreen Alu
- Reflex
- Safescreen
- Silente 10
- Twin Blackout
- Umbrascreen

Width	60cm	80cm	100cm	120cm	140cm	160cm	180cm	200cm	220cm	230cm	240cm	Width
Drop cm												Drop cm
60	271.55	295.19	318.69	342.28	365.88	389.49	413.01	436.66	460.18	472.00	483.82	60
80	285.99	314.37	342.76	371.18	399.59	427.95	456.39	484.73	513.14	527.34	541.53	80
100	300.40	333.65	366.87	400.07	433.24	466.43	499.67	532.84	566.09	582.85	599.72	100
120	314.88	352.87	390.87	428.91	466.90	504.91	542.97	580.95	618.96	637.99	657.03	120
140	329.30	372.08	414.93	457.77	500.59	543.44	586.21	629.04	671.87	693.30	714.73	140
160	343.69	391.34	439.04	486.60	534.23	581.87	629.56	677.16	724.77	748.60	772.44	160
180	358.13	410.59	463.06	515.46	567.93	620.38	672.78	725.26	777.67	803.84	830.03	180
200	372.59	429.82	487.08	544.36	601.59	658.83	716.09	773.39	830.63	859.27	887.89	200
220	386.98	449.07	511.17	573.21	635.23	697.33	759.41	821.45	883.54	914.58	945.62	220
240	401.46	468.31	535.22	602.05	668.89	735.78	802.67	869.58	936.48	969.91	1003.34	240
260	415.84	487.53	559.20	630.93	702.59	774.31	845.96	917.63	989.33	1025.17	1061.00	260
280	430.29	506.79	583.28	659.80	736.24	812.77	889.28	965.75	1042.20	1080.44	1118.69	280
300	444.69	526.03	607.36	688.64	769.95	851.30	932.56	1013.85	1095.14	1135.77	1176.40	300

### SG 4910 – Side-by-Side System

There is no add-on. Simply order two systems, stating side-by-side.

Intermediate Cover 10632 required.

### SG 4910 – Hardware only

Supplied ready-assembled incl. adhesive tape for customers to mount own fabrics. Standard chain drop 1.00m. Bottom bar is not included – see page 52.

Side-guide wire option is available at an additional cost of £47.70.

Spring Clutch Set	Width of blind up to											
	60cm	80cm	100cm	120cm	140cm	160cm	180cm	200cm	220cm	240cm	240cm	
10545/46/51/52	196.15	199.73	203.34	206.97	210.56	214.17	217.77	221.36	224.96	228.59	226.79	
10547/48/53/54	227.02	230.78	234.53	238.29	242.00	245.79	249.49	253.26	256.95	258.81	266.59	
10549/55/10697/98/99/10700	233.44	237.13	240.87	244.59	248.25	251.97	255.69	259.41	263.09	266.81		

Note: To determine the correct spring clutch set please consult Silent Gliss.

Child safety device (10482) – add-on £9.55.

### SG 4910 complete with Box Fascia

Width	60cm	80cm	100cm	120cm	140cm	160cm	180cm	200cm	220cm	240cm	Width
	62.96	72.36	81.76	94.03	103.42	112.82	122.22	131.62	143.88	153.28	

### Continuous Headrail

Provides an alternative to fitting to the wall or ceiling, supplied made to measure in silver or white (other custom colours available, pricing as per page 73), for use on 4900, 4910, 4930, 4960 and 4970. £27.97 per m add on.



# Roller Blinds

## SG 4930

Heavy duty chain operated  
Roller Blind system.  
Tube diameter 60mm.

\*Max. surface area 17m<sup>2</sup>

\*Max. m<sup>2</sup> depends on fabric type.

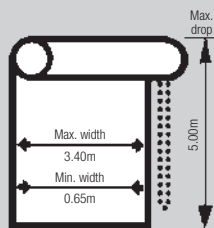

### SG 4930 complete with fabric

The prices below comprise the complete system made-to-measure, ready to hang with fabric of your choice. Brackets, bracket covers, bottom bar and bottom bar endcaps supplied as standard in either white, grey or black. Please be aware that due to the size capabilities of this system, larger sizes can only be achieved by welding the fabric. Fabrics that can be welded are indicated below in bold print. Please consult application chart (page 56) to ensure that fabric desired can be supplied in dimensions required.

Price Category C

#### Price Group 1R

Colorama 1  
Colorama 1 Alu  
Element  
**Puma**  
Basic Screen 5%  
Basic Screen 10%

Width ► Drop ▼	100cm	125cm	150cm	175cm	200cm	225cm	250cm	275cm	300cm	325cm	340cm	◀ Width ▼ Drop
50cm	332.14	361.98	391.58	422.22	451.00	489.94	511.35	540.13	569.88	599.57	617.39	50cm
100cm	351.79	386.88	421.57	456.31	491.01	525.76	560.45	595.11	629.86	664.59	685.42	100cm
150cm	372.18	411.89	451.58	491.27	531.03	570.73	610.44	650.16	689.84	729.57	753.41	150cm
200cm	392.17	436.87	481.57	526.28	571.00	615.70	660.44	705.15	749.87	794.58	821.40	200cm
250cm	412.16	461.87	511.60	561.30	611.02	660.73	710.44	760.16	809.87	859.59	889.42	250cm
300cm	432.18	486.88	541.62	596.32	650.98	705.73	760.43	815.16	869.89	924.58	957.40	300cm
350cm	452.18	511.88	571.61	631.32	691.01	750.74	810.47	870.14	929.88	989.58	1025.39	350cm
400cm	472.18	536.90	601.59	666.30	731.01	795.74	860.49	925.18	989.87	1054.57	1093.39	400cm
450cm	492.18	561.92	631.57	701.28	771.01	840.74	910.51	980.22	1049.86	1119.57	1161.39	450cm
500cm	512.18	586.94	661.55	736.26	811.01	885.74	960.53	1035.26	1109.85	1184.56	1229.39	500cm

#### Price Group 2R

Alutex  
Basic Screen 1%  
Colorama 2  
Colorama 2 Alu  
Colorama 2 Bioactive  
**Dualscreen 1%**  
**Dualscreen 3%**  
**Dualscreen 5%**  
Mercurio B  
Multi Shadow  
Multi Visio

**Multiscreen 1%**  
**Multiscreen 5%**  
**Multiscreen 10%**  
Newlife Screen  
Nox  
Optiscreen  
Silente 20  
Slimscreen  
**Versascreen 1%**  
**Versascreen 5%**  
**Versascreen 10%**

Width ► Drop ▼	100cm	125cm	150cm	175cm	200cm	225cm	250cm	275cm	300cm	325cm	340cm	◀ Width ▼ Drop
50cm	357.60	393.62	429.75	465.84	506.67	537.94	574.01	610.06	646.12	682.21	703.87	50cm
100cm	390.30	434.55	478.79	523.02	567.28	611.53	655.78	700.03	744.29	788.52	815.05	100cm
150cm	423.02	475.44	527.85	580.25	632.71	685.11	737.57	789.98	842.43	894.86	926.31	150cm
200cm	455.73	516.33	576.92	637.51	698.15	758.73	819.35	879.94	940.54	1001.14	1037.50	200cm
250cm	488.43	557.21	626.01	694.79	763.55	832.34	901.12	969.90	1038.69	1110.51	1153.60	250cm
300cm	521.13	598.13	675.08	752.05	829.03	905.94	982.93	1059.92	1136.81	1213.80	1260.00	300cm
350cm	553.89	639.00	724.11	809.27	894.42	979.56	1064.70	1149.83	1235.00	1317.10	1366.35	350cm
400cm	586.57	679.91	773.22	866.51	959.85	1053.16	1146.46	1239.81	1333.19	1420.39	1472.71	400cm
450cm	619.25	720.82	822.33	923.75	1025.28	1126.76	1228.22	1329.79	1431.38	1523.69	1579.07	450cm
500cm	651.93	761.73	871.44	980.99	1090.71	1200.36	1309.98	1419.77	1529.57	1626.98	1685.43	500cm

#### Price Group 3R

**Aluscreen Futura**  
Deep  
Ecoscreen  
Jumbotex  
Lightscreen  
Linea  
Linea Alu  
Moon  
Newlife 1  
Newlife 2

Newlife Screen Alu  
Optiscreen Alu  
Reflex  
Safescreen  
Silente 10  
Twin Blackout  
Umbrascreen

Width ► Drop ▼	100cm	125cm	150cm	175cm	200cm	225cm	250cm	275cm	300cm	325cm	340cm	◀ Width ▼ Drop
50cm	412.47	462.27	512.04	561.85	611.64	661.45	711.22	761.04	810.83			50cm
100cm	472.61	537.47	602.30	667.13	731.96	796.79	861.61	926.44	991.28			100cm
150cm	532.79	612.67	692.52	772.41	852.28	932.17	1012.04	1091.87	1171.74			150cm
200cm	592.96	687.84	782.74	877.67	972.57	1067.50	1162.42	1257.34	1352.25			200cm
250cm	653.12	763.07	873.01	982.95	1092.91	1202.86	1312.79	1422.74	1532.70			250cm
300cm	713.23	838.24	963.25	1088.25	1213.24	1338.22	1463.21	1588.19	1713.17			300cm
350cm	773.45	913.46	1053.49	1193.50	1333.53	1473.55	1613.62	1753.64	1893.66			350cm
400cm	833.58	988.66	1143.73	1298.79	1453.85	1608.92	1764.00	1919.24	2074.15			400cm
450cm	893.71	1063.86	1233.97	1404.08	1574.17	1744.29	1914.38	2084.84	2254.64			450cm
500cm	953.84	1139.06	1324.21	1509.37	1694.49	1879.66	2064.76	2250.44	2435.13			500cm

### 4930 – Hardware only

Headrail supplied ready-assembled including adhesive tape for customers to mount own fabric.  
White aluminium bottom bar included as standard.

Width ►	100cm	125cm	150cm	175cm	200cm	225cm	250cm	275cm	300cm	325cm	340cm	◀ Width
	292.16	311.85	331.60	351.29	371.00	390.70	410.44	430.15	449.88	469.56	481.36	

Side-Guiding: Side-guide wires with accessories: Please add £55.41 per system.

### SG 4930 – Double System

There is no add-on for a double system. Simply price as two separate systems and order a double system.

### Continuous Headrail

Provides an alternative to fitting to the wall or ceiling, supplied made to measure in silver or white (other custom colours available, pricing as per page 73), for use on 4900, 4910, 4930, 4960 and 4970.  
£27.97 per m add on.

Prices shown exclude VAT



# Roller Blinds

## SG 4930 – Double Connected System

Heavy duty chain operated Roller Blind system.  
Tube diameter 60mm.

\*Max. surface area 30m<sup>2</sup> (15m<sup>2</sup> for each panel of side by side system)

\*Max. m<sup>2</sup> depends on fabric type.

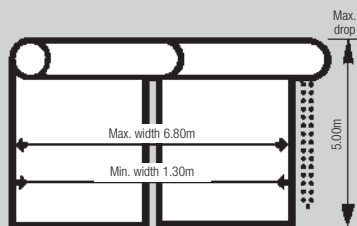

### SG 4930 – Double Connected System complete with fabric

The prices below comprise the complete system made-to-measure, ready to hang with fabric of your choice. Brackets, bracket covers, bottom bar and bottom bar endcaps supplied as standard in either white, grey or black. Please be aware that due to the size capabilities of this system, larger sizes can only be achieved by welding the fabric. Fabrics that can be welded are indicated below in bold print. If a system is required as a double system smaller than widths indicated below, please add £92.78 to single system price. Please consult application chart (page 56) to ensure that fabric desired can be supplied in dimensions required.

Price Category C

#### Price Group 1R

Colorama 1  
Colorama 1 Alu  
Element  
**Puma**  
Basic Screen 5%  
Basic Screen 10%

Width ► Drop ▼	350cm	375cm	400cm	425cm	450cm	475cm	500cm	525cm	550cm	575cm	600cm	625cm	650cm	680cm	◀Width ▼ Drop
50cm	758.69	788.43	818.12	847.82	877.56	907.28	936.95	966.67	996.41	1026.09	1055.81	1085.53	1115.26	1150.93	50cm
100cm	828.69	863.41	898.13	932.83	967.57	1002.29	1036.97	1071.72	1106.40	1141.13	1175.85	1210.54	1245.25	1286.90	100cm
150cm	898.70	938.40	978.13	1017.87	1057.58	1097.29	1136.97	1176.70	1216.41	1256.14	1295.81	1335.60	1375.24	1422.80	150cm
200cm	968.73	1013.42	1058.11	1102.84	1147.56	1192.26	1237.00	1281.71	1326.42	1371.12	1415.84	1460.55	1505.22	1558.83	200cm
250cm	1038.69	1088.42	1138.14	1187.82	1237.55	1287.27	1337.03	1386.72	1436.43	1486.10	1535.87	1585.50	1635.21	1694.87	250cm
300cm	1108.72	1163.44	1218.17	1272.80	1327.54	1382.28	1437.06	1491.73	1546.44	1601.08	1655.90	1710.45	1765.20	1830.90	300cm
350cm	1178.75	1238.46	1298.20	1357.78	1417.53	1477.29	1537.09	1596.74	1656.45	1716.06	1775.93	1835.40	1895.19	1966.94	350cm
400cm	1248.78	1313.48	1378.23	1442.76	1507.52	1572.30	1637.12	1701.75	1766.46	1831.04	1895.96	1960.35	2025.18	2102.97	400cm
450cm	1318.81	1388.50	1458.26	1527.74	1597.51	1667.31	1737.15	1806.76	1876.47	1946.02	2015.99	2085.30	2155.17		450cm
500cm	1388.84	1463.52	1538.29	1612.72	1687.50	1762.32	1837.18	1911.77	1986.48	2061.00	2136.02				500cm

#### Price Group 2R

Alutex  
Basic Screen 1%  
Colorama 2  
Colorama 2 Alu  
Colorama 2 Bioactive  
**Dualscreen 1%**  
**Dualscreen 3%**  
**Dualscreen 5%**  
Mercurio B  
Multi Shadow  
Multi Visio

**Multiscreen 1%**  
**Multiscreen 5%**  
**Multiscreen 10%**  
Newlife Screen  
Nox  
Optiscreen  
Silente 20  
Slimscreen  
**Versascreen 1%**  
**Versascreen 5%**  
**Versascreen 10%**

Width ► Drop ▼	350cm	375cm	400cm	425cm	450cm	475cm	500cm	525cm	550cm	575cm	600cm	625cm	650cm	680cm	◀Width ▼ Drop
50cm	847.67	883.72	919.83	955.90	991.95	1028.02	1064.12	1100.16	1136.23	1172.29	1208.38	1244.43	1280.52	1323.83	50cm
100cm	962.18	1006.40	1050.66	1094.93	1139.18	1183.41	1227.69	1271.93	1316.16	1360.38	1404.61	1448.90	1493.14	1546.22	100cm
150cm	1076.68	1129.11	1181.51	1233.96	1286.38	1338.75	1391.22	1443.67	1496.05	1548.50	1600.96	1653.34	1705.75	1768.64	150cm
200cm	1191.17	1251.63	1312.36	1372.98	1433.58	1494.21	1554.81	1615.44	1676.05	1736.61	1797.22	1857.79	1918.36	1991.05	200cm
250cm	1305.68	1374.48	1443.24	1511.97	1580.78	1649.60	1718.40	1787.21	1856.05	1924.72	1993.48	2062.24	2130.97	2213.46	250cm
300cm	1420.15	1497.14	1574.12	1650.96	1727.98	1804.99	1881.99	1958.98	2036.05	2112.83	2189.74				300cm
350cm	1534.66	1619.80	1705.00	1789.95	1875.18	1960.38	2045.58	2130.75	2216.05	2300.94	2386.00				350cm
400cm	1649.16	1742.46	1835.88	1928.94	2022.38	2115.77	2209.17	2302.52	2396.05	2489.05	2582.26				400cm
450cm	1763.65	1865.12	1966.76	2067.93	2169.58	2271.16	2372.76	2474.29	2576.05	2677.16	2778.52				450cm
500cm	1878.15	1987.78	2097.64	2206.92	2316.78	2426.55	2536.35	2646.06	2756.05	2865.27	2974.78				500cm

#### Price Group 3R

**Aluscreen Futura**  
Deep  
Ecoscreen  
Jumbotex  
Lightscreen  
Linea  
Linea Alu  
Moon  
Newlife 1  
Newlife 2

Newlife Screen Alu  
Optiscreen Alu  
Reflex  
Safescreen  
Silente 10  
Twin Blackout  
Umbrascreen

Width ► Drop ▼	350cm	375cm	400cm	425cm	450cm	475cm	500cm	525cm	550cm	575cm	600cm	625cm	650cm	680cm	◀Width ▼ Drop
50cm	1039.79	1089.55	1139.39	1189.19	1238.98	1288.75	1338.55	1388.35	1438.16	1487.90	1537.73				50cm
100cm	1250.34	1315.18	1379.99	1444.84	1509.67	1574.46	1639.33	1704.14	1769.04	1833.81	1898.69				100cm
150cm	1460.88	1540.75	1620.64	1700.50	1780.40	1860.23	1940.11	2020.01	2099.84	2179.75	2259.61				150cm
200cm	1671.47	1766.36	1861.28	1956.20	2051.10	2146.01	2240.93	2335.83	2430.73	2525.66	2620.57				200cm
250cm	1882.02	1991.96	2101.93	2211.86	2321.77	2431.77	2541.75	2651.65	2761.62	2871.57	2981.53				250cm
300cm	2092.56	2217.54	2342.58	2467.52	2592.44	2717.53	2842.57	2967.47	3092.51	3217.48	3342.49				300cm
350cm	2303.10	2443.12	2583.23	2723.18	2863.11	3003.29	3143.39	3283.29	3423.40	3563.39	3703.45				350cm
400cm	2513.64	2668.70	2823.88	2978.84	3133.78	3289.05	3444.21	3599.11	3754.29	3909.30	4064.41				400cm
450cm	2724.18	2894.28	3064.53	3234.50	3404.45	3574.81	3745.03	3914.93	4085.18	4255.21	4425.37				450cm
500cm	2934.72	3119.86	3305.18	3490.16	3675.12	3860.57	4045.85	4230.75	4416.07	4601.12	4786.33				500cm

### SG 4930 Double Connected System – Hardware only

Double headrail system supplied ready-assembled including adhesive tape for customers to mount own fabric. White aluminium bottom bar included as standard.

Width ►	100cm	150cm	200cm	250cm	300cm	350cm	400cm	450cm	500cm	550cm	600cm	650cm	680cm	◀Width
	421.54	460.99	500.43	539.86	579.24	618.66	658.15	697.53	736.97	776.36	815.82	855.22	878.86	

Side-Guiding: Side-guide wires with accessories: Please add £110.83 per double system.

### Continuous Headrail

Provides an alternative to fitting to the wall or ceiling, supplied made to measure in silver or white (other custom colours available, pricing as per page 73), for use on 4900, 4910, 4930, 4960 and 4970.  
£27.97 per m add on.



# Roller Blinds

## SG 4840

Heavy duty chain operated Roller Blind system.  
 Tube diameter 80mm (up to 3.95m width).  
 Tube diameter 110mm (over 3.95m width).  
 Max. surface area 15m<sup>2</sup>

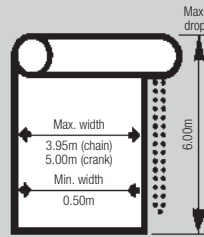

### SG 4840 complete with fabric

The prices below comprise the complete system made-to-measure, ready to hang with fabric of your choice. Please be aware that due to the size capabilities of this system, larger sizes can only be achieved by welding the fabric. Fabrics that can be welded are indicated below in bold print. Please consult application chart (page 56) to ensure that the fabric desired can be supplied in dimensions required. System sizes in shaded areas are available as crank operated only (fixed or detachable).

Price Category C

#### Price Group 1R

Colorama 1  
 Colorama 1 Alu  
 Element  
**Puma**  
**Basic Screen 5%**  
**Basic Screen 10%**

Width ► Drop ▼	100cm	150cm	200cm	250cm	300cm	350cm	400cm	450cm	500cm	◀ Width ▼ Drop
50cm	651.53	725.86	800.21	874.49	948.84	1023.13	1149.84	1224.11	1298.45	50cm
100cm	670.77	754.68	838.69	922.60	1006.54	1090.46	1226.82	1310.73	1394.69	100cm
150cm	690.01	783.58	877.14	970.71	1064.25	1157.84	1303.79	1397.34	1490.87	150cm
200cm	709.24	812.44	915.64	1018.81	1121.96	1225.13	1380.78	1483.93	1587.13	200cm
250cm	728.55	841.28	954.11	1066.94	1179.69	1292.52	1457.70	1570.51	1683.33	250cm
300cm	747.73	870.13	992.61	1115.03	1237.44	1359.87	1534.66	1657.05	1779.43	300cm
350cm	766.99	898.99	1031.09	1163.12	1295.18	1427.20	1611.64			350cm
400cm	786.26	927.90	1069.56	1211.25	1352.93	1494.57				400cm
450cm	805.49	956.77	1108.05	1259.34	1410.62					450cm
500cm	824.72	985.60	1146.47	1307.47	1468.36					500cm
550cm	843.96	1014.49	1185.00	1355.52						550cm
600cm	863.22	1043.34	1223.48	1403.63					Max. 15m <sup>2</sup>	600cm

#### Price Group 2R

Alutex  
 Basic Screen 1%  
 Colorama 2  
 Colorama 2 Alu  
 Colorama 2 Bioactive  
**Dualscreen 1%**  
**Dualscreen 3%**  
**Dualscreen 5%**  
 Mercurio B  
 Multi Shadow  
 Multi Visio  
**Multiscreen 1%**  
**Multiscreen 5%**  
**Multiscreen 10%**

Newlife Screen  
 Nox  
 Optiscreen  
 Silente 20  
 Slimscreen  
**Versascreen 1%**  
**Versascreen 5%**  
**Versascreen 10%**

Width ► Drop ▼	100cm	150cm	200cm	250cm	300cm	350cm	400cm	450cm	500cm	◀ Width ▼ Drop
50cm	675.96	762.46	849.03	935.55	1022.09	1108.67	1247.55	1334.07	1420.61	50cm
100cm	707.38	809.69	911.92	1014.19	1116.46	1218.72	1373.38	1475.61	1577.90	100cm
150cm	738.88	856.88	974.85	1092.83	1210.82	1328.80	1499.19	1617.20	1735.19	150cm
200cm	770.34	904.05	1037.75	1171.52	1305.21	1438.94	1625.05	1758.76	1892.42	200cm
250cm	801.78	951.25	1100.69	1250.16	1399.54	1548.99	1750.88	1900.26	2049.71	250cm
300cm	833.25	998.42	1163.59	1328.74	1493.94	1659.07	1876.67	2041.83	2207.03	300cm
350cm	864.71	1045.58	1226.47	1407.41	1588.30	1769.19	2002.48			350cm
400cm	896.15	1092.78	1289.40	1486.06	1682.68	1879.31				400cm
450cm	927.62	1139.92	1352.33	1564.69	1777.04					450cm
500cm	959.05	1187.15	1415.27	1643.34	1871.43					500cm
550cm	990.57	1234.35	1478.14	1721.97						550cm
600cm	1022.00	1281.54	1541.06	1800.59					Max. 15m <sup>2</sup>	600cm

#### Price Group 3R

**Aluscreen Futura**  
 Deep  
 Ecoscreen  
 Jumbotex  
 Lightscreen  
 Linea  
 Linea Alu  
 Moon  
 Newlife 1  
 Newlife 2

Newlife Screen Alu  
 Optiscreen Alu  
 Reflex  
 Safescreen  
 Silente 10  
 Twin Blackout  
 Umbrascreen

Width ► Drop ▼	100cm	150cm	200cm	250cm	300cm	350cm	400cm	450cm	500cm	◀ Width ▼ Drop
50cm	728.74	841.69	954.65	1067.53	1180.50	1293.41	1458.72	1571.68	1684.58	50cm
100cm	786.56	928.44	1070.32	1212.17	1354.02	1495.85	1690.15	1831.99	1973.82	100cm
150cm	844.49	1015.23	1186.00	1356.80	1527.58	1698.41	1921.53	2092.31	2263.14	150cm
200cm	902.32	1102.00	1301.76	1501.45	1701.14	1900.87	2152.97	2352.67	2552.37	200cm
250cm	960.17	1188.80	1417.42	1646.10	1874.68	2103.34	2384.39	2612.99	2841.63	250cm
300cm	1018.02	1275.57	1533.16	1790.68	2048.28	2305.84	2615.75	2873.33	3130.95	300cm
350cm	1075.88	1362.37	1648.82	1935.35	2221.84	2508.31	2847.18			350cm
400cm	1133.71	1449.15	1764.58	2079.96	2395.40	2710.80				400cm
450cm	1191.60	1535.88	1880.25	2224.64	2568.94					450cm
500cm	1249.43	1622.70	1995.95	2369.22	2742.51					500cm
550cm	1307.27	1709.48	2111.70	2513.87						550cm
600cm	1365.12	1796.23	2227.35	2658.54					Max. 15m <sup>2</sup>	600cm

Note: All fabrics are FR

Should crank operated be required for systems under 3.95m width add the following supplement to the system prices above.

Fixed crank (150cm): £40.01 per system  
 Detachable crank (150cm): £51.38 per system  
 To extend crank drop add an additional £1.66 per 10cm

Side-Guiding of SG 4840 Side-guide wires are available as an option. Please add £190.07 per system (Cat. 'C').

Prices shown exclude VAT



# Roller Blinds

## SG 4955

Battery operated  
Roller Blind system.  
Tube diameter 41mm.

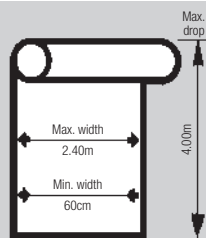

### SG 4955 complete with fabric

The prices below comprise the complete system made-to-measure, ready to hang with fabric of your choice. Please consult application chart (page 56 of our main price list) to ensure that fabric desired can be supplied in dimensions required.

#### Price Category C

#### Price Group 1R

Colorama 1  
Colorama 1 Alu  
Element  
**Puma**  
**Basic Screen 5%**  
**Basic Screen 10%**

Width ► Drop ▼	60cm	80cm	100cm	120cm	140cm	160cm	180cm	200cm	220cm	240cm	◀ Width ▼ Drop
60cm	661.70	673.63	685.57	696.25	706.92	717.59	728.25	740.18	763.12	775.05	60cm
80cm	665.09	678.03	690.98	702.74	714.51	726.29	738.03	750.96	775.05	788.00	80cm
100cm	668.49	682.43	696.36	709.23	722.09	735.00	747.80	761.75	787.01	800.95	100cm
120cm	671.87	686.81	701.77	715.72	729.67	743.70	757.58	772.54	798.95	813.90	120cm
140cm	675.23	691.19	707.15	722.18	737.26	752.32	767.38	783.35	810.88	826.84	140cm
160cm	678.62	695.58	712.54	728.67	744.84	761.03	777.16	794.12	822.83	839.79	160cm
180cm	681.99	699.97	717.94	735.18	752.46	769.71	786.91	804.87	834.75	852.73	180cm
200cm	685.39	704.36	723.34	741.68	760.05	778.41	796.68	815.67	846.69	865.67	200cm
220cm	688.77	708.76	728.75	748.17	767.63	787.12	806.46	826.45	858.64	878.62	220cm
240cm	692.14	713.13	734.11	754.67	775.19	795.72	816.28	837.27	870.56	891.54	240cm
260cm	695.53	717.52	739.52	761.17	782.78	804.42	826.05	848.05	882.49	904.49	260cm
280cm	698.87	721.88	744.89	767.64	790.40	813.08	835.83	858.86	894.42	917.44	280cm
300cm	702.26	726.27	750.28	774.13	797.98	821.79	845.63	869.64	906.36	930.38	300cm
320cm	705.64	730.67	755.69	780.63	805.57	830.50	855.40	880.41	918.32	943.33	320cm
340cm	709.03	735.05	761.09	787.11	813.12	839.14	865.14	891.16	930.25	956.27	340cm
360cm	712.42	738.45	766.48	793.59	820.70	847.84	874.91	901.94	942.19	969.22	360cm
380cm	715.78	743.82	771.87	800.07	828.25	856.48	884.67	912.71	954.13	982.17	380cm
400cm	719.18	748.21	777.26	806.56	835.85	865.18	894.44	923.50	966.07	995.12	400cm

#### Price Group 2R

Alutex  
Basic Screen 1%  
Colorama 2  
Colorama 2 Alu  
Colorama 2 Bioactive  
**Dualscreen 1%**  
**Dualscreen 3%**  
**Dualscreen 5%**  
Mercurio B  
Multi Shadow  
Multi Visio  
**Multiscreen 1%**  
**Multiscreen 5%**  
**Multiscreen 10%**

Newlife Screen  
Nox  
Optiscreen  
Silente 20  
Silmscreen  
**Versascreen 1%**  
**Versascreen 5%**  
**Versascreen 10%**

Width ► Drop ▼	60cm	80cm	100cm	120cm	140cm	160cm	180cm	200cm	220cm	240cm	◀ Width ▼ Drop
60cm	672.43	687.56	702.68	716.83	730.96	745.12	759.26	774.40	801.00	816.12	60cm
80cm	677.95	694.71	711.48	727.45	743.37	759.34	775.25	792.03	820.50	837.28	80cm
100cm	683.47	701.88	720.30	738.07	755.77	773.54	791.24	809.65	840.01	858.42	100cm
120cm	688.99	709.04	729.11	748.69	768.17	787.74	807.22	827.29	859.50	879.56	120cm
140cm	694.54	716.24	737.95	759.24	780.58	801.88	823.21	844.91	879.02	900.72	140cm
160cm	700.06	723.40	746.75	769.86	792.98	816.09	839.19	862.54	898.53	921.88	160cm
180cm	705.57	730.58	755.57	780.44	805.34	830.23	855.18	880.17	918.04	943.04	180cm
200cm	711.10	737.74	764.38	791.06	817.76	844.45	871.16	897.80	937.54	964.18	200cm
220cm	716.61	744.91	773.19	801.68	830.16	858.66	887.14	915.42	957.05	985.33	220cm
240cm	722.17	752.10	782.02	812.25	842.55	872.80	903.10	933.05	976.55	1006.47	240cm
260cm	727.70	759.26	790.83	822.85	854.97	886.99	919.09	950.66	996.05	1027.62	260cm
280cm	733.16	766.38	799.61	833.50	867.32	901.20	935.09	968.31	1015.56	1048.79	280cm
300cm	738.70	773.56	808.44	844.10	879.72	915.39	951.06	985.93	1035.07	1069.94	300cm
320cm	744.21	780.71	817.22	854.71	892.10	929.59	967.05	1003.57	1054.58	1091.09	320cm
340cm	749.78	787.93	826.08	865.35	904.57	943.78	983.01	1021.16	1074.07	1112.22	340cm
360cm	755.30	795.10	834.90	875.97	916.96	957.98	998.99	1038.79	1093.58	1133.38	360cm
380cm	760.84	802.28	843.71	886.57	929.37	983.78	1014.96	1056.41	1113.08	1154.53	380cm
400cm	766.36	809.45	852.53	897.19	941.77	1005.72	1030.95	1074.04	1132.59	1175.66	400cm

#### Price Group 3R

**Aluscreen Futura**  
Deep  
Ecoscreen  
Jumbotex  
Lightscreen  
Linea  
Linea Alu  
Moon  
Newlife 1  
Newlife 2

Newlife Screen Alu  
Reflex  
Safescreen  
Silente 10  
Twin Blackout  
Umbrascreen

Width ► Drop ▼	60cm	80cm	100cm	120cm	140cm	160cm	180cm	200cm	220cm	240cm	◀ Width ▼ Drop
60cm	695.59	717.62	739.65	761.33	783.00	804.65	826.33	848.35	882.84	904.87	60cm
80cm	705.76	730.82	755.87	780.83	805.79	830.76	855.71	880.77	918.71	943.77	80cm
100cm	715.92	744.01	772.09	800.33	828.58	856.88	885.11	913.19	954.58	1060.54	100cm
120cm	726.09	757.19	788.29	819.83	851.37	882.98	914.51	945.61	990.47	1021.56	120cm
140cm	736.21	770.34	804.47	839.32	874.20	909.06	943.87	978.01	1026.33	1060.46	140cm
160cm	746.38	783.53	820.69	858.82	896.99	935.16	973.27	1010.41	1062.21	1099.36	160cm
180cm	756.52	796.71	836.89	878.35	919.83	961.24	1002.67	1042.84	1098.08	1138.26	180cm
200cm	766.69	809.89	853.11	897.85	942.61	987.35	1032.05	1075.27	1133.97	1177.17	200cm
220cm	776.85	823.07	869.31	917.37	965.42	1013.44	1061.46	1107.69	1169.83	1216.07	220cm
240cm	787.01	836.27	885.52	936.85	988.21	1039.56	1090.83	1140.09	1205.70	1254.96	240cm
260cm	797.18	849.45	901.73	956.36	1011.01	1065.66	1120.23	1172.51	1241.57	1293.87	260cm
280cm	807.34	862.65	917.96	975.89	1033.86	1091.72	1149.66	1204.97	1277.47	1332.78	280cm
300cm	817.51	875.84	934.18	995.39	1056.66	1117.84	1179.05	1237.38	1313.34	1371.68	300cm
320cm	827.68	889.03	950.39	1014.89	1079.45	1143.95	1208.44	1269.80	1349.22	1410.57	320cm
340cm	837.82	902.22	966.60	1034.41	1102.19	1170.00	1237.83	1302.21	1385.10	1449.48	340cm
360cm	847.99	915.40	982.82	1053.91	1124.98	1196.11	1267.23	1334.63	1420.97	1488.38	360cm
380cm	858.18	928.60	999.04	1073.44	1147.74	1222.14	1296.62	1367.04	1456.84	1527.27	380cm
400cm	868.34	941.79	1015.25	1092.94	1170.54	1248.26	1326.00	1399.46	1492.72	1566.18	400cm

#### SG 4955 Control Options (Category A)

The above system includes the 10949 wall switch.  
The above system is compatible with the below controls at an additional cost.

- 10946 Radio hand-held transmitter 1 channel
- 10947 Radio hand-held transmitter 2 + 1 channel
- 10948 Radio hand-held transmitter 6 + 1 channel
- 10950 Radio wall transmitter 2 channel
- 10951 Radio wall transmitter 5 + 1 channel
- 11092 Timer White

Please see prices on page 86

Bottom Bar: The above system is available with round (4221), rectangular (10633), or oval (10634), bottom bar

Prices shown exclude VAT





# Roller Blinds

## SG 4960

Electric roller blind system.  
Mains voltage.

Speed: 12cm/sec. approx.

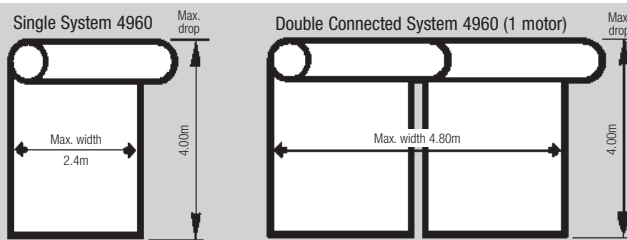

Minimum width dependant on motor type. Refer to catalogue.

### SG 4960 complete with fabric

The prices below comprise the complete system made-to-measure, ready to hang with fabric of your choice. System sizes in shaded areas available as side-by-side systems only. Please consult application chart (page 52) to ensure that fabric desired can be supplied in dimensions required.

Price Category C

#### Price Group 1R

- Colorama 1
- Colorama 1 Alu
- Element
- Puma
- Basic Screen 5%
- Basic Screen 10%

Width ▶ Drop ▼	100cm	125cm	150cm	175cm	200cm	225cm	240cm	250cm	275cm	300cm	325cm	350cm	375cm	400cm	425cm	450cm	460cm	480cm	◀Width ▼ Drop
50cm	803.37	818.65	833.93	849.18	864.46	879.74	904.21	925.68	940.92	956.16	971.47	986.73	1001.49	1016.20	1030.94	1045.08	1054.41	1067.14	50cm
100cm	819.26	838.49	857.72	877.01	896.17	915.35	942.29	965.33	984.56	1003.76	1023.01	1042.22	1061.50	1080.70	1099.95	1119.21	1126.90	1142.30	100cm
150cm	835.11	858.29	881.50	904.74	927.92	951.11	980.36	1004.98	1028.14	1051.33	1074.52	1097.73	1120.96	1144.17	1167.35	1190.58	1199.83	1218.34	150cm
200cm	850.99	878.15	905.34	932.52	959.60	986.71	1018.43	1044.64	1071.75	1098.93	1126.09	1153.25	1180.47	1207.57	1234.76	1261.91	1272.77	1294.46	200cm
250cm	866.85	898.00	929.09	960.22	991.35	1022.50	1056.48	1084.27	1115.37	1146.46	1177.60	1208.74	1239.89	1271.03	1302.17	1333.29	1345.74	1370.65	250cm
300cm	882.69	917.80	952.94	988.00	1023.10	1058.18	1094.56	1123.95	1159.02	1194.13	1229.20	1264.27	1299.39	1334.48	1369.58				300cm
350cm	898.56	937.63	976.68	1015.74	1054.76	1093.81	1132.64	1163.57	1202.67	1241.72	1280.78	1319.79	1358.87	1397.94	1436.99				350cm
400cm	914.43	957.44	1000.43	1043.48	1086.46	1129.44	1170.73	1203.20	1246.34	1286.34	1332.38	1375.28	1418.36	1461.41	1504.42			Max. 12m <sup>2</sup>	400cm

#### Price Group 2R

- Alutex
- Basic Screen 1%
- Colorama 2
- Colorama 2 Alu
- Colorama 2 Bioactive
- Mercurio B
- Dualscreen 1%
- Dualscreen 3%
- Dualscreen 5%
- Multi Shadow
- Multi Visio
- Multiscreen 1%
- Multiscreen 5%
- Multiscreen 10%
- Newlife Screen
- Nox
- Optiscreen
- Silente 20
- Slimscreen
- Versascreen 1%
- Versascreen 5%
- Versascreen 10%

Width ▶ Drop ▼	100cm	125cm	150cm	175cm	200cm	225cm	240cm	250cm	275cm	300cm	325cm	350cm	375cm	400cm	425cm	450cm	460cm	480cm	◀Width ▼ Drop
50cm	821.50	841.28	861.07	880.87	900.68	921.12	947.70	970.88	990.68	1010.48	1030.29	1050.10	1069.91	1089.68	1109.49	1129.29	1137.21	1153.06	50cm
100cm	847.41	873.73	899.98	926.29	952.53	978.77	1009.90	1035.77	1062.00	1088.26	1114.54	1140.83	1167.12	1193.38	1219.68	1245.93	1256.46	1277.52	100cm
150cm	873.36	906.10	938.88	971.62	1004.37	1037.14	1072.13	1100.56	1133.29	1166.07	1198.79	1231.56	1264.31	1297.05	1329.81	1362.56	1375.68	1401.90	150cm
200cm	899.27	938.51	977.73	1016.98	1056.23	1095.50	1134.33	1165.36	1204.56	1243.78	1283.05	1322.27	1361.52	1400.75	1439.82	1479.24	1494.94	1526.34	200cm
250cm	925.21	970.88	1016.63	1062.31	1108.06	1153.81	1196.53	1230.14	1275.87	1321.58	1367.31	1413.04	1458.75	1504.43	1550.13	1595.92	1614.16	1650.64	250cm
300cm	951.09	1003.31	1055.48	1107.69	1159.92	1212.12	1258.74	1294.94	1347.16	1399.32	1451.55	1503.71	1555.92	1608.17	1660.28				300cm
350cm	977.04	1035.77	1094.41	1153.07	1211.73	1270.40	1320.94	1359.74	1418.46	1477.13	1535.78	1594.44	1653.13	1711.82	1770.48				350cm
400cm	1002.98	1068.18	1133.32	1212.22	1263.57	1328.68	1383.15	1424.53	1489.77	1554.96	1620.05	1685.17	1750.32	1815.48	1880.68			Max. 12m <sup>2</sup>	400cm

#### Price Group 3R

- Aluscreen Futura
- Deep
- Ecoscreen
- Jumbotex
- Lightscreen
- Linea
- Linea Alu
- Moon
- Newlife 1
- Newlife 2
- Newlife Screen Alu
- Optiscreen Alu
- Reflex
- Safescreen
- Silente 10
- Twin Blackout
- Umbrascreen

Width ▶ Drop ▼	100cm	125cm	150cm	175cm	200cm	225cm	240cm	250cm	275cm	300cm	325cm	350cm	375cm	400cm	425cm	450cm	460cm	480cm	◀Width ▼ Drop
50cm	860.64	890.25	919.84	949.38	978.99	1008.60	1041.67	1068.81	1098.38	1128.00	1157.56	1187.14	1216.70	1246.30	1275.87	1305.49	1317.32	1341.04	50cm
100cm	908.33	949.82	991.31	1032.85	1074.34	1115.84	1156.08	1188.01	1229.51	1270.97	1312.53	1354.02	1395.53	1436.99	1478.50	1520.03	1536.60	1569.74	100cm
150cm	955.98	1009.39	1062.85	1116.28	1169.66	1223.05	1270.48	1307.19	1360.62	1414.05	1467.42	1520.85	1574.30	1627.72	1681.16	1734.56	1755.90	1798.61	150cm
200cm	1003.65	1069.01	1134.37	1199.71	1265.02	1330.36	1384.91	1426.35	1491.72	1557.04	1622.38	1687.72	1753.06	1818.40	1883.74	1949.08	1975.22	2027.51	200cm
250cm	1051.33	1128.59	1205.88	1283.15	1360.35	1437.54	1499.31	1545.53	1622.77	1700.05	1777.32	1854.57	1931.82	2009.08	2086.35	2163.60	2194.56	2256.43	250cm
300cm	1099.03	1188.20	1277.44	1366.57	1455.74	1544.91	1613.74	1664.74	1753.90	1843.09	1932.28	2021.40	2110.60	2199.75	2288.40				300cm
350cm	1146.72	1247.80	1348.86	1449.97	1551.09	1652.22	1728.15	1783.91	1884.97	1986.10	2087.17	2188.32	2289.35	2390.48	2491.55				350cm
400cm	1194.41	1307.41	1420.31	1533.35	1646.42	1759.51	1842.57	1903.08	2016.00	2129.09	2242.07	2355.24	2468.13	2581.22	2694.73			Max. 12m <sup>2</sup>	400cm

#### SG 4960 Control Options

Standard Radio Controlled option – with System 0450, see page 28.

Series 40 motors – With integrated radio receiver for operation with SG wireless system 9940 – add on £195.00 per system, see page 28.

SMART by Silent Gliss motors – for use with Silent Gliss Gateway and associated components – add on £195.00 per system, see page 28.

### SG 4960 – Hardware only

Headrail supplied ready-assembled including adhesive tape for customers to mount own fabric. White aluminium bottom bar included as standard. System sizes in shaded areas available as double systems only.

Width ▶	100cm	125cm	150cm	175cm	200cm	225cm	230cm	240cm	250cm	275cm	300cm	325cm	350cm	375cm	400cm	425cm	450cm	460cm	480cm	◀Width
	752.27	760.16	768.10	775.98	783.89	791.80	793.34	818.98	844.64	852.52	860.37	868.28	876.17	884.02	891.90	899.83	907.69	911.05	917.77	

Note: If a double connected system is required below 2.30m (e.g. for fabric reasons) please add £41.55 to single system price.

For side guided option add £45.03 per system.

### SG 4960 complete with Box Fascia

Width ▶	100cm	125cm	150cm	175cm	200cm	225cm	230cm	240cm	◀Width
	79.38	90.78	102.19	116.38	127.79	139.19	141.47	146.03	

#### Continuous Headrail

Provides an alternative to fitting to the wall or ceiling, supplied made to measure in silver or white (other custom colours available, pricing as per page 73), for use on 4900, 4910 and 4960. £27.97 per m add on.

4960 LV 24V DC – LV1/LV2/LV3 (optional) – supplement £178.45.

Prices shown exclude VAT

Design bracket options on page 52.



# Roller Blinds

## SG 4970

Heavy duty electrically operated Roller Blind system. Mains voltage. Speed approx. 7cm/sec. Tube diameter 60mm.

\*Max. surface area 17m<sup>2</sup>  
\*Max. m<sup>2</sup> depends on fabric type.

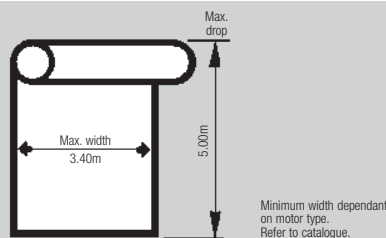

### SG 4970 complete with fabric

The prices below comprise the complete system made-to-measure, ready to hang with fabric of your choice. Brackets, bracket covers, bottom bar and bottom bar endcaps supplied as standard in either white, grey or black. Please be aware that due to the size capabilities of this system, larger sizes can only be achieved by welding the fabric. Fabrics that can be welded are indicated below in bold print. Please consult application chart (page 52) to ensure that fabric desired can be supplied in dimensions required.

Price Category C

#### Price Group 1R

Colorama 1  
Colorama 1 Alu  
Element  
**Puma**  
**Basic Screen 5%**  
**Basic Screen 10%**

Width ► Drop ▼	100cm	125cm	150cm	175cm	200cm	225cm	250cm	275cm	300cm	325cm	340cm	◀ Width ▼ Drop
50cm	1119.77	1142.62	1165.48	1188.34	1211.18	1234.01	1256.88	1279.75	1302.57	1325.43	1339.14	50cm
100cm	1139.61	1167.38	1195.20	1223.02	1250.82	1278.60	1306.42	1334.21	1362.00	1389.79	1406.47	100cm
150cm	1159.43	1192.17	1224.92	1257.68	1290.44	1323.17	1355.90	1388.67	1421.45	1454.19	1473.84	150cm
200cm	1179.22	1216.90	1254.60	1292.34	1330.05	1367.75	1405.44	1443.14	1480.86	1518.57	1541.19	200cm
250cm	1199.03	1241.71	1284.35	1327.00	1369.67	1412.28	1454.97	1497.64	1540.28	1582.92	1608.51	250cm
300cm	1218.84	1266.43	1314.07	1361.64	1409.26	1456.91	1504.51	1552.11	1599.72	1647.34	1675.91	300cm
350cm	1238.66	1291.19	1343.80	1396.35	1448.91	1501.45	1553.98	1606.59	1659.11	1711.68	1743.22	350cm
400cm	1258.45	1315.98	1373.48	1431.02	1488.51	1546.02	1603.56	1661.06	1718.56	1776.07	1810.57	400cm
450cm	1278.28	1340.70	1403.21	1465.65	1528.15	1590.58	1653.09	1715.53	1778.01	1840.46	1877.93	450cm
500cm	1298.05	1365.48	1432.91	1500.31	1567.73	1635.17	1702.61	1769.97	1837.46	1904.85	1945.29	500cm

#### Price Group 2R

Alutex  
Basic Screen 1%  
Colorama 2  
Colorama 2 Alu  
Colorama 2 Bioactive  
**Dualscreen 1%**  
**Dualscreen 3%**  
**Dualscreen 5%**  
Mercurio B  
Multi Shadow  
Multi Visio

**Multiscreen 1%**  
**Multiscreen 5%**  
**Multiscreen 10%**  
Newlife Screen  
Nox  
Optiscreen  
Silente 20  
Silmscreen  
**Versascreen 1%**  
**Versascreen 5%**  
**Versascreen 10%**

Width ► Drop ▼	100cm	125cm	150cm	175cm	200cm	225cm	250cm	275cm	300cm	325cm	340cm	◀ Width ▼ Drop
50cm	1132.39	1158.36	1184.37	1210.36	1236.38	1262.35	1288.35	1314.33	1340.36	1366.34	1381.92	50cm
100cm	1164.80	1198.88	1232.96	1267.05	1301.20	1335.25	1369.36	1403.43	1437.53	1471.65	1492.12	100cm
150cm	1197.20	1239.38	1281.58	1323.76	1365.96	1408.14	1450.34	1492.55	1534.76	1576.93	1602.23	150cm
200cm	1229.58	1279.89	1330.17	1380.47	1430.76	1481.03	1531.35	1581.63	1631.95	1682.23	1712.39	200cm
250cm	1261.95	1320.38	1378.77	1437.17	1495.57	1553.94	1612.35	1670.72	1729.11	1787.50	1822.54	250cm
300cm	1294.37	1360.88	1427.37	1493.89	1560.34	1626.85	1693.34	1759.85	1826.35	1892.83	1932.71	300cm
350cm	1326.78	1401.33	1475.96	1550.55	1641.38	1699.76	1774.36	1848.92	1923.56	1998.14	2042.89	350cm
400cm	1359.19	1441.86	1524.60	1607.25	1689.97	1772.66	1855.35	1938.04	2020.70	2103.41	2153.03	400cm
450cm	1391.59	1482.35	1573.16	1663.97	1754.75	1845.54	1936.36	2027.13	2117.95	2208.67	2263.11	450cm
500cm	1423.93	1522.89	1621.77	1720.68	1819.55	1918.43	2017.33	2116.26	2215.20	2313.94	2373.18	500cm

#### Price Group 3R

**Aluscreen Futura**  
Deep  
Ecoscreen  
Jumbotex  
Lightstext  
Linea  
Linea Alu  
Moon  
Newlife 1  
Newlife 2

Newlife Screen Alu  
Optiscreen Alu  
Reflex  
Safescreen  
Silente 10  
Twin Blackout  
Umbrascreen

Width ► Drop ▼	100cm	125cm	150cm	175cm	200cm	225cm	250cm	275cm	300cm	325cm	340cm	◀ Width ▼ Drop
50cm	1159.58	1192.32	1225.11	1257.96	1290.72	1323.52	1356.28	1389.06	1421.92			50cm
100cm	1219.15	1266.83	1314.52	1362.20	1409.91	1457.58	1505.25	1552.94	1600.64			100cm
150cm	1278.75	1341.31	1403.90	1466.46	1529.02	1591.67	1654.22	1716.76	1779.40			150cm
200cm	1338.28	1415.78	1493.24	1570.74	1648.22	1725.66	1803.16	1880.64	1958.11			200cm
250cm	1397.89	1490.26	1582.62	1675.00	1767.39	1859.75	1952.12	2044.50	2136.89			250cm
300cm	1457.47	1564.73	1672.01	1779.27	1886.54	1993.82	2101.08	2208.30	2315.57			300cm
350cm	1517.06	1639.18	1761.37	1883.51	2005.71	2127.86	2250.01	2372.16	2494.34			350cm
400cm	1576.61	1713.67	1850.73	1987.78	2124.88	2261.91	2398.99	2536.04	2673.09			400cm
450cm	1636.21	1788.13	1940.11	2092.05	2244.03	2395.98	2547.91	2699.86	2851.84			450cm
500cm	1695.76	1862.62	2029.50	2196.30	2363.19	2529.99	2696.86	2863.73	3030.59			500cm

Note: All fabrics are FR

#### SG 4970 Control Options

Standard Radio Controlled option – With System 0450, see page 28.

Series 40 motors – With integrated radio receiver for operation with SG wireless system 9940 – add on £195.00 per system, see page 28.

SMART by Silent Gliss motors – for use with Silent Gliss Gateway and associated components – add on £195.00 per system, see page 28.

#### SG 4970 – Hardware only

Headrail system supplied ready-assembled including adhesive tape for customers to mount own fabric.

Bottom bar in white is included as standard.

Width ►	100cm	125cm	150cm	175cm	200cm	225cm	250cm	275cm	300cm	325cm	340cm	◀ Width
	1099.96	1117.88	1135.75	1153.66	1171.57	1189.44	1207.39	1225.26	1243.16	1261.05	1271.78	

Side-Guiding: Side-guide wires with accessories: Please add £70.32 per system.

#### Continuous Headrail

Provides an alternative to fitting to the wall or ceiling, supplied made to measure in silver or white (other custom colours available, pricing as per page 73), for use on 4900, 4910, 4930, 4960 and 4970.

£27.97 per m add on.



# Roller Blinds

## SG 4970 – Double Connected System

Heavy duty electrically operated Roller Blind system. Mains voltage. Speed approx. 7cm/sec. Tube diameter 60mm.

Max. surface area 34m<sup>2</sup> (17m<sup>2</sup> for each panel of side by side system)

\*Max. m<sup>2</sup> depends on fabric type.

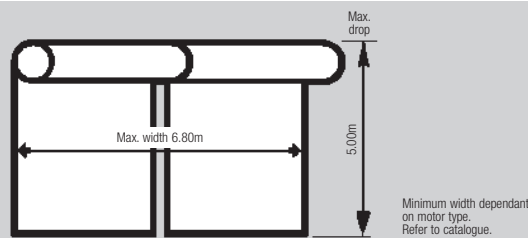

## SG 4970 – Double Connected System

The prices below comprise the complete system made-to-measure, ready to hang with fabric of your choice. Brackets, bracket covers, bottom bar and bottom bar endcaps supplied as standard in either white, grey or black. Please be aware that due to the size capabilities of this system, larger sizes can only be achieved by welding the fabric. Fabrics that can be welded are indicated below in bold print. If a system is required as a double system smaller than widths indicated below, please add £85.58 to single system price. Please consult application chart (page 56) to ensure that fabric desired can be supplied in dimensions required.

### Price Category C

#### Price Group 1R

Colorama 1  
Colorama 1 Alu  
Element  
**Puma**  
**Basic Screen 5%**  
**Basic Screen 10%**

Width ▶ Drop ▼	350cm	375cm	400cm	425cm	450cm	475cm	500cm	525cm	550cm	575cm	600cm	625cm	650cm	680cm	◀Width ▼ Drop
50cm	1460.29	1483.16	1506.04	1528.88	1551.73	1574.53	1597.40	1620.27	1643.09	1665.95	1688.79	1711.63	1734.49	1761.92	50cm
100cm	1529.63	1557.44	1585.24	1613.06	1640.84	1668.66	1696.48	1724.26	1752.06	1779.85	1807.65	1835.46	1863.25	1896.60	100cm
150cm	1598.96	1631.70	1664.46	1697.23	1729.98	1762.72	1795.49	1828.23	1860.98	1893.71	1926.51	1959.28	1992.00	2031.27	150cm
200cm	1668.33	1706.02	1743.73	1781.43	1819.12	1856.81	1894.52	1932.26	1969.96	2007.68	2045.34	2083.03	2120.75	2166.02	200cm
250cm	1737.63	1780.32	1822.96	1865.61	1908.27	1950.90	1993.58	2036.27	2078.88	2121.56	2164.19	2206.87	2249.50	2300.66	250cm
300cm	1806.98	1854.59	1902.21	1949.80	1997.40	2045.02	2092.63	2140.23	2187.82	2235.45	2283.06	2330.87	2378.25	2435.11	300cm
350cm	1876.32	1928.86	1981.43	2034.00	2086.56	2139.06	2191.69	2244.19	2296.80	2349.35	2401.93	2454.49	2507.00	2570.02	350cm
400cm	1945.62	2003.15	2060.69	2118.10	2175.68	2233.20	2290.71	2348.22	2405.73	2463.27	2520.78	2578.11	2635.75	2704.92	400cm
450cm	2014.95	2077.43	2139.91	2202.39	2264.85	2327.32	2389.76	2452.24	2514.66	2577.19	2639.63	2701.73	2764.50	2839.83	450cm
500cm	2084.26	2151.72	2219.14	2286.55	2353.97	2421.44	2488.81	2556.26	2623.59	2691.11	2758.48	2825.35	2893.25	2974.73	500cm

#### Price Group 2R

Alutex  
Basic Screen 1%  
Colorama 2  
Colorama 2 Alu  
Colorama 2 Bioactive  
**Dualscreen 1%**  
**Dualscreen 3%**  
**Dualscreen 5%**  
Mercurio B  
Multi Shadow  
Multi Visio

**Multiscreen 1%**  
**Multiscreen 5%**  
**Multiscreen 10%**  
Newlife Screen  
Nox  
Optiscreen  
Silente 20  
Slimscreen  
**Versascreen 1%**  
**Versascreen 5%**  
**Versascreen 10%**

Width ▶ Drop ▼	350cm	375cm	400cm	425cm	450cm	475cm	500cm	525cm	550cm	575cm	600cm	625cm	650cm	680cm	◀Width ▼ Drop
50cm	1504.37	1530.34	1556.36	1582.38	1608.35	1634.35	1660.30	1686.36	1712.35	1738.34	1764.31	1790.32	1816.34	1847.57	50cm
100cm	1617.76	1651.87	1686.35	1720.06	1754.16	1788.24	1822.34	1856.44	1890.53	1924.61	1958.74	1992.82	2026.91	2067.82	100cm
150cm	1731.17	1773.37	1815.56	1857.75	1899.95	1942.16	1984.34	2026.51	2068.71	2110.89	2153.11	2195.29	2237.51	2288.18	150cm
200cm	1844.57	1894.86	1945.18	1995.44	2045.72	2096.06	2146.36	2196.64	2246.93	2297.22	2347.50	2397.84	2448.11	2508.44	200cm
250cm	1957.97	2016.37	2074.77	2133.16	2191.53	2249.97	2308.32	2366.72	2425.11	2483.53	2541.92	2600.32	2658.71	2728.78	250cm
300cm	2071.36	2137.85	2204.34	2270.85	2337.32	2403.87	2470.34	2536.83	2603.35	2669.81	2736.31	2802.81	2869.31	2949.11	300cm
350cm	2184.78	2259.33	2333.99	2408.55	2483.17	2557.75	2632.32	2706.94	2781.48	2856.11	2930.70	3005.28	3079.91	3169.47	350cm
400cm	2298.16	2380.88	2463.53	2546.24	2628.95	2711.65	2794.32	2877.09	2959.71	3042.43	3125.06	3207.75	3290.51	3389.83	400cm
450cm	2411.54	2502.36	2593.16	2683.93	2774.74	2865.52	2956.32	3047.13	3137.94	3228.75	3319.42	3410.22	3501.11		450cm
500cm	2524.95	2623.87	2722.78	2821.63	2920.54	3019.39	3118.32	3217.17	3316.17	3415.07	3513.78	3612.69			500cm

#### Price Group 3R

**Aluscreen Futura**  
Deep  
Ecoscreen  
Jumbotex  
Lightscreen  
Linea  
Linea Alu  
Moon  
Newlife 1  
Newlife 2

Newlife Screen Alu  
Optiscreen Alu  
Reflex  
Safescreen  
Silente 10  
Twin Blackout  
Umbrascreen

Width ▶ Drop ▼	350cm	375cm	400cm	425cm	450cm	475cm	500cm	525cm	550cm	575cm	600cm	625cm	650cm	680cm	◀Width ▼ Drop
50cm	1599.50	1632.27	1665.11	1697.89	1730.69	1763.46	1796.23	1829.03	1861.82	1894.61	1927.42	1960.23	1993.04	2025.85	50cm
100cm	1808.04	1855.72	1903.42	1951.08	1998.81	2046.49	2094.17	2141.84	2189.54	2237.22	2284.91	2332.60	2380.29	2427.98	100cm
150cm	2016.56	2078.81	2141.76	2204.32	2266.92	2329.47	2392.06	2454.62	2517.17	2579.72	2642.27	2704.82	2767.37	2829.92	150cm
200cm	2225.11	2302.58	2380.06	2457.54	2534.99	2612.48	2689.97	2767.41	2844.90	2922.41	2999.91	3077.42	3154.93	3232.44	200cm
250cm	2433.62	2525.99	2618.39	2710.74	2803.11	2895.51	2987.83	3080.23	3172.61	3265.00	3357.35	3449.74	3542.13	3634.52	250cm
300cm	2642.18	2749.41	2856.71	2963.98	3071.25	3178.51	3285.79	3393.01	3500.30	3607.54	3714.79	3822.03	3929.27	4036.51	300cm
350cm	2850.74	2972.86	3095.04	3217.18	3339.35	3461.49	3583.67	3705.86	3827.98	3950.18	4072.33	4194.53	4316.73	4438.93	350cm
400cm	3059.24	3196.31	3333.35	3470.40	3607.43	3744.49	3881.58	4018.64	4155.70	4292.75	4429.87	4566.98	4704.09	4841.20	400cm
450cm	3267.77	3419.68	3571.68	3723.63	3875.56	4027.51	4179.46	4331.42	4483.42	4635.42	4787.41	4939.41	5091.41	5243.41	450cm
500cm	3476.25	3643.18	3810.02	3976.85	4143.69	4310.53	4477.34	4644.20	4811.14	4978.09	5145.05	5312.01	5478.97	5645.93	500cm

### SG 4970 Double Connected System Control Options

Standard Radio Controlled option – With System 0450, see page 28.

Series 40 motors – With integrated radio receiver for operation with SG wireless system 9940 – add on £195.00 per system, see page 28.

SMART by Silent Gliss motors – for use with Silent Gliss Gateway and associated components – add on £195.00 per system, see page 28.

### SG 4970 Double Connected System – Hardware only

Double headrail system supplied ready-assembled including adhesive tape for customers to mount own fabric. Bottom bar in white is included as standard.

Width ▶ Drop ▼	120cm	150cm	200cm	250cm	300cm	350cm	400cm	450cm	500cm	550cm	600cm	650cm	680cm	◀Width ▼ Drop
	1212.01	1247.81	1283.64	1319.39	1355.17	1391.00	1426.79	1462.53	1498.35	1534.14	1569.94	1605.71	1627.17	

Side-Guiding: Side-guide wires with accessories: Please add £109.82 per side-by-side system.

### Continuous Headrail

Provides an alternative to fitting to the wall or ceiling, supplied made to measure in silver or white (other custom colours available, pricing as per page 73), for use on 4900, 4910, 4930, 4960 and 4970.

£27.97 per m add on.

Prices shown exclude VAT

Note: All fabrics are FR.



# Roller Blinds

## SG 4880

Heavy duty electrically operated  
Roller Blind system. Mains voltage.  
Speed approx. 7cm/sec.

Max. surface area 36m<sup>2</sup>

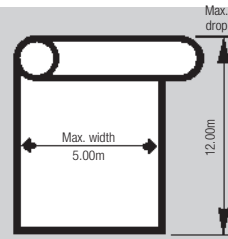

Minimum width dependent  
on motor type.  
Refer to catalogue.

### SG 4880 complete with fabric

The prices below comprise the complete system made-to-measure, ready to hang with fabric of your choice. Please be aware that due to the size capabilities of this system, larger sizes can only be achieved by welding the fabric. Fabrics that can be welded are indicated over in bold print. Please consult application chart (page 56) to ensure that fabric desired can be supplied in dimensions required.

Price Group 1R

Price Category 'C'

Width ► Drop ▼	100cm	150cm	200cm	250cm	300cm	350cm	400cm	450cm	500cm	◀ Width ▼ Drop
50cm	1292.45	1366.76	1441.12	1515.44	1589.76	1664.08	1738.39	1812.69	1887.05	50cm
100cm	1311.72	1395.66	1479.62	1563.51	1647.45	1731.43	1815.36	1899.31	1983.24	100cm
150cm	1330.95	1424.51	1518.07	1611.63	1705.22	1798.76	1892.33	1985.89	2079.46	150cm
200cm	1350.19	1453.36	1556.55	1659.74	1762.96	1866.11	1969.32	2072.46	2175.66	200cm
250cm	1369.44	1482.25	1595.05	1707.84	1820.65	1933.46	2046.26	2159.06	2271.87	250cm
300cm	1388.67	1511.11	1633.56	1755.96	1878.37	2000.80	2123.24	2245.69	2368.06	300cm
350cm	1407.92	1539.96	1672.02	1804.07	1936.11	2068.14	2200.20	2332.24	2464.29	350cm
400cm	1427.16	1568.83	1710.50	1852.15	1993.87	2135.52	2277.18	2418.85	2560.52	400cm
450cm	1446.41	1597.68	1748.96	1900.26	2051.57	2202.85	2354.15	2505.42	2656.71	450cm
500cm	1465.64	1626.56	1787.46	1948.40	2109.30	2270.19	2431.08	2592.06	2752.91	500cm
550cm	1484.92	1655.42	1825.94	1996.46	2167.03	2337.53	2508.07	2678.63	2849.13	550cm
600cm	1504.14	1684.30	1864.41	2044.56	2224.73	2404.89	2585.05	2765.18	2945.33	600cm
650cm	1523.40	1713.14	1902.85	2092.69	2282.46	2472.22	2662.00	2851.77		650cm
700cm	1542.64	1742.01	1941.37	2140.78	2340.21	2539.58	2738.99	2938.37		700cm
750cm	1561.89	1770.86	1979.86	2188.88	2397.94	2606.94	2815.95	3024.97		750cm
800cm	1581.15	1799.73	2018.35	2237.01	2455.63	2674.28	2892.91	3111.53		800cm
850cm	1600.35	1828.63	2056.83	2285.08	2513.38	2741.62	2969.83			850cm
900cm	1619.60	1857.48	2095.32	2333.20	2571.12	2808.96	3046.80			900cm
950cm	1638.83	1886.33	2133.80	2381.30	2628.83	2876.34				950cm
1000cm	1658.03	1915.23	2172.32	2429.44	2686.58	2943.63				1000cm
1050cm	1677.32	1944.06	2210.78	2477.52	2744.33					1050cm
1100cm	1696.55	1972.93	2249.27	2525.66	2802.03					1100cm
1150cm	1715.80	2001.79	2287.76	2573.73	2859.72					1150cm
1200cm	1735.01	2030.63	2326.27	2621.85	2917.43					1200cm

Price Group 2R

Width ► Drop ▼	100cm	150cm	200cm	250cm	300cm	350cm	400cm	450cm	500cm	◀ Width ▼ Drop
50cm	1316.91	1403.43	1489.94	1576.54	1663.08	1749.57	1836.09	1922.66	2009.14	50cm
100cm	1348.34	1450.62	1552.87	1655.17	1757.42	1859.69	1961.90	2064.22	2166.46	100cm
150cm	1379.81	1497.82	1615.77	1733.77	1851.75	1969.76	2087.76	2205.76	2323.74	150cm
200cm	1411.23	1544.99	1678.69	1812.42	1946.11	2079.88	2213.58	2347.31	2481.00	200cm
250cm	1442.72	1592.16	1741.61	1891.06	2040.53	2189.98	2339.42	2488.88	2638.29	250cm
300cm	1474.18	1639.36	1804.51	1969.70	2134.87	2300.05	2465.20	2630.42	2795.58	300cm
350cm	1505.64	1686.52	1867.41	2048.33	2229.26	2410.17	2591.05	2771.95	2952.88	350cm
400cm	1537.07	1733.69	1930.34	2126.96	2323.59	2520.25	2716.85	2913.52	3110.15	400cm
450cm	1568.56	1780.93	1993.26	2205.64	2418.01	2630.35	2842.70	3055.05	3267.40	450cm
500cm	1599.99	1828.11	2056.19	2284.27	2512.33	2740.42	2968.52	3196.63	3424.70	500cm
550cm	1631.45	1875.29	2119.08	2362.87	2606.74	2850.53	3094.36	3338.16	3581.99	550cm
600cm	1662.90	1922.46	2181.99	2441.54	2701.08	2960.61	3220.15	3479.71	3739.26	600cm
650cm	1694.35	1969.63	2244.89	2520.16	2795.48	3070.67	3346.00	3621.25		650cm
700cm	1725.82	2016.84	2307.80	2598.81	2889.81	3180.80	3471.81	3762.83		700cm
750cm	1757.27	2063.99	2370.72	2677.42	2984.21	3290.90	3597.65	3904.35		750cm
800cm	1788.72	2111.21	2433.62	2756.08	3078.55	3401.02	3723.44	4045.89		800cm
850cm	1820.22	2158.37	2496.53	2834.75	3172.88	3511.11	3849.31			850cm
900cm	1851.65	2205.54	2559.44	2913.38	3267.28	3621.19	3975.12			900cm
950cm	1883.10	2252.71	2622.37	2992.00	3361.66	3731.31				950cm
1000cm	1914.55	2299.93	2685.30	3070.63	3456.02	3841.41				1000cm
1050cm	1946.01	2347.13	2748.22	3149.30	3550.42					1050cm
1100cm	1977.47	2394.32	2811.13	3227.98	3644.73					1100cm
1150cm	2008.96	2441.47	2874.03	3306.57	3739.13					1150cm
1200cm	2040.38	2488.66	2936.95	3385.21	3833.50					1200cm

Price Group 3R

Width ► Drop ▼	100cm	150cm	200cm	250cm	300cm	350cm	400cm	450cm	500cm 16'5"	◀ Width ▼ Drop
50cm	1369.70	1482.64	1595.55	1708.51	1821.44	1934.36	2047.28	2160.21	2273.13	50cm
100cm	1427.54	1569.40	1711.29	1853.10	1994.96	2136.88	2278.69	2420.55	2562.41	100cm
150cm	1485.40	1656.19	1826.94	1997.76	2168.54	2339.35	2510.08	2680.88	2851.65	150cm
200cm	1543.26	1742.97	1942.64	2142.38	2342.08	2541.80	2741.54	2941.19	3140.94	200cm
250cm	1601.09	1829.75	2058.36	2287.00	2515.65	2744.33	2972.92	3201.61	3430.16	250cm
300cm	1658.95	1916.56	2174.08	2431.67	2689.21	2946.78	3204.33	3461.92	3719.46	300cm
350cm	1716.76	2003.29	2289.76	2576.26	2862.78	3149.27	3435.73	3722.23	4008.70	350cm
400cm	1774.66	2090.08	2405.52	2720.92	3036.30	3351.74	3667.16	3982.56	4297.95	400cm
450cm	1832.51	2176.85	2521.20	2865.53	3209.86	3554.24	3898.59	4242.92	4587.25	450cm
500cm	1890.37	2263.64	2636.89	3010.20	3383.42	3756.71	4130.01	4503.26	4876.51	500cm
550cm	1948.20	2350.40	2752.59	3154.78	3557.04	3959.21	4361.35	4763.56	5165.77	550cm
600cm	2006.06	2437.20	2868.29	3299.44	3730.53	4161.68	4592.81	5023.95	5455.02	600cm
650cm	2063.93	2524.00	2984.03	3444.05	3904.14	4364.14	4824.18	5284.26		650cm
700cm	2121.72	2610.75	3099.71	3588.68	4077.66	4566.68	5055.65	5544.57		700cm
750cm	2179.64	2697.52	3215.42	3733.32	4251.25	4769.16	5287.05	5804.97		750cm
800cm	2237.49	2784.29	3331.14	3877.97	4424.83	4971.65	5518.45	6065.26		800cm
850cm	2295.36	2871.10	3446.85	4022.58	4598.38	5174.12	5749.86			850cm
900cm	2353.17	2957.90	3562.51	4167.19	4771.91	5376.59	5981.26			900cm
950cm	2411.04	3044.64	3678.26	4311.88	4945.47	5579.08				950cm
1000cm	2468.88	3131.42	3793.94	4456.47	5119.02	5781.55				1000cm
1050cm	2526.75	3218.22	3909.64	4601.11	5292.59					1050cm
1100cm	2584.61	3304.97	4025.36	4745.78	5466.14					1100cm
1150cm	2642.48	3391.76	4141.02	4890.36	5639.68					1150cm
1200cm	2700.27	3478.53	4256.76	5035.04	5813.26					1200cm

Side-Guiding of SG 4880 Side-guide wires are available as an option. Please add £190.08 per system (Cat. 'C').

Prices shown exclude VAT

System Control Options – Radio control standard option is with System 0450, see page 28.

Series 40 motors – With integrated radio receiver for operation with SG wireless system 9940 – add on £250.00 per system, see page 28.

SMART by Silent Gliss motors – for use with Silent Gliss Gateway and associated components – add on £250.00 per system, see page 28.





# Roller Blind Fabric Application Chart

Although each roller blind hardware system has its own width and drop restrictions, some of the bigger sizes may not be achievable due to limitations on original fabric width and whether the fabric can be used 'width for drop'. Always ensure the fabric for your roller blind system can be fitted within the guideline dimensions below. If in doubt please contact Silent Gliss.

System Info	Fabric width cm	Fabric weight Grams	4900 Max m <sup>2</sup> = 6				4910 Max m <sup>2</sup> = 7.2				4930 Max m <sup>2</sup> = 17				4907 Max m <sup>2</sup> = 4.5			
			Max width: 200cm		Max drop: 300cm		Max width: 240cm		Max drop: 300cm		Max width: 340cm		Max drop: 500cm		Max width: 180cm		Max drop: 280cm	
			Maximising width	Drop cm	Maximising width	Drop cm	Maximising width	Drop cm	Maximising width	Drop cm	Maximising width	Drop cm	Maximising width	Drop cm	Maximising width	Drop cm	Maximising width	Drop cm
Aluscreen Futura	230	320	200	300	180	300	220	300	220	300	300	500	180	250	160	280		
Alutex	240	220	200	300	200	300	230	300	230	300	230	500	180	250	160	280		
<b>Basic Screen 1%</b>	250	480	Fabric not suitable		Fabric not suitable		240	260	210	300	300	300	250	500	180	250		
<b>Basic Screen 5%</b>	250	410	200	200	140	300	240	300	240	300	300	400	275	500	180	250		
<b>Basic Screen 10%</b>	250	340	200	230	180	300	240	300	240	300	300	400	300	500	180	280		
Colorama 1	200	135	190	300	190	300	190	300	190	300	190	500	190	500	180	250		
*Colorama 1 Alu	340	135	200	300	200	300	240	300	240	300	330	500	330	500	180	250		
Colorama 2	200	140	200	300	120	300	180	300	180	300	280	500	280	500	180	250		
*Colorama 2 Alu	340	250	190	300	190	300	240	300	240	300	330	500	330	500	180	250		
Colorama 2 Bioactive	290	255	200	300	200	300	180	300	180	300	280	500	280	500	180	250		
Deep	200	290	190	300	190	300	190	300	190	300	190	500	190	500	180	250		
Deep	290	325	200	200	160	300	240	300	240	300	280	500	280	500	180	250		
<b>Dualscreen 1%</b>	250	450	Fabric not suitable		Fabric not suitable		240	300	240	300	300	350	250	500	Fabric not suitable			
<b>Dualscreen 3%</b>	250	430	200	200	160	300	240	300	240	300	300	350	275	500	180	250		
<b>Dualscreen 5%</b>	250	410	200	200	160	300	240	300	240	300	300	400	275	500	180	250		
Ecoscreen	325	270	200	200	180	300	240	300	240	300	300	500	300	500	180	250		
Element	235	220	200	300	200	300	225	300	225	300	225	500	225	500	180	250		
*Element	300	220	200	300	200	300	240	300	240	300	290	500	290	500	180	250		
Jumbotex	500	545	Fabric not suitable		Fabric not suitable		240	200	160	270	300	300	225	500	180	250		
Lightscreen	300	315	200	270	160	300	240	300	240	300	300	500	300	500	180	250		
Linea	300	240	200	300	200	300	240	300	240	300	290	500	290	500	180	250		
Linea Alu	300	106	200	300	200	300	240	300	240	300	290	500	290	500	180	250		
Mercurio B	235	340	200	230	180	300	225	300	225	300	225	500	225	500	180	250		
*Mercurio B	300	340	200	230	180	300	240	300	240	300	290	500	290	500	180	250		
Moon	240	390	200	200	170	300	230	300	230	300	230	500	230	500	180	250		
Multi Shadow	235	170	200	300	200	300	230	300	230	300	230	500	230	500	180	250		
Multi Visio	240	210	200	300	200	300	230	300	230	300	230	500	230	500	180	250		
<b>Multiscreen 1%</b>	250	440	Fabric not suitable		Fabric not suitable		240	300	240	300	300	350	250	500	180	250		
<b>Multiscreen 5%</b>	250	410	200	200	160	300	240	300	240	300	300	400	275	500	180	250		
<b>Multiscreen 10%</b>	250	350	200	230	180	300	240	300	240	300	300	450	300	500	180	250		
Newlife 1	300	110	200	300	200	300	240	300	240	300	295	500	290	500	180	250		
Newlife 2	300	160	200	300	200	300	240	300	240	300	295	500	290	500	180	250		
Newlife Screen	320	215	200	300	200	300	240	300	240	300	300	500	300	500	180	250		
Newlife Screen Alu	240	215	200	300	200	300	230	300	230	300	230	500	230	500	180	250		
Nox	300	340	200	230	180	300	240	300	240	300	290	500	290	500	180	250		
Optiscreen	300	290	200	300	200	300	240	300	240	300	290	500	290	500	180	250		
Optiscreen Alu	240	290	Fabric not suitable		Fabric not suitable		230	300	230	300	230	500	230	500	Fabric not suitable			
<b>Puma</b>	250	407	200	200	140	300	240	300	240	300	300	400	275	500	180	250		
*Puma	300	407	200	200	140	300	240	300	240	300	300	400	275	500	180	250		
Reflex	240	170	200	300	200	300	230	300	230	300	230	500	230	500	180	250		
Safescreen	240	170	200	300	200	300	230	300	230	300	230	500	230	500	180	250		
Silente 10	300	160	200	300	200	300	240	300	240	300	300	500	300	500	180	250		
Silente 20	320	131	200	300	200	300	240	300	240	300	300	500	300	500	180	250		
<b>Slimscreen</b>	250	290	200	300	200	300	240	300	240	300	300	500	300	500	180	250		
Twin Blackout	275	360	200	230	180	300	240	300	240	300	265	500	265	500	180	250		
<b>Umbrascreen</b>	250	410	200	200	140	300	240	300	240	300	300	400	275	500	180	250		
<b>Versascreen 1%</b>	300	520	Fabric not suitable		Fabric not suitable		240	200	180	300	300	300	225	500	180	250		
<b>Versascreen 5%</b>	300	420	200	190	140	300	240	300	240	300	300	350	275	500	180	250		
<b>Versascreen 10%</b>	300	400	200	200	150	300	240	300	240	300	300	450	275	500	180	250		

\*Mercurio B only available in 300cm in colours 01/04/28/35/44. \*Puma only available in colours, 900, 909 and 933. \*Element only available in colours 01/02/04/17

\*Colorama 1 and 2 in 340cm width only available in colours 400/401/402/410/429/442.

System Info	Fabric width cm	Fabric weight Grams	4840 Max m <sup>2</sup> = 15				4955 Max m <sup>2</sup> = 9.6				4960 Max m <sup>2</sup> = 9.6				4970 Max m <sup>2</sup> = 17				4880 Max m <sup>2</sup> = 36			
			Max width: 500cm		Max drop: 600cm		Max width: 240cm		Max drop: 400cm		Max width: 240cm		Max drop: 400cm*		Max width: 340cm		Max drop: 500cm		Max width: 500cm		Max drop: 1200cm	
			Maximising width	Drop cm	Maximising width	Drop cm	Maximising width	Drop cm	Maximising width	Drop cm	Maximising width	Drop cm	Maximising width	Drop cm	Maximising width	Drop cm	Maximising width	Drop cm	Maximising width	Drop cm	Maximising width	Drop cm
Aluscreen Futura	230	320	500	300	250	600	220	260	160	390	240	400	300	500	300	500	500	720	300	1200		
Alutex	240	220	230	600	230	600	230	340	220	390	240	160	230	400	230	500	230	1200	230	1200		
<b>Basic Screen 1%</b>	250	480	500	290	240	600	240	150	150	270	240	400	240	400	300	500	300	500	500	720		
<b>Basic Screen 5%</b>	250	410	500	300	250	600	240	180	155	320	240	400	240	400	300	500	300	500	500	720		
<b>Basic Screen 10%</b>	250	340	500	410	340	600	240	210	170	350	240	400	240	400	300	500	300	500	500	720		
Colorama 1	200	135	190	600	190	600	240	400	190	400	240	400	190	500	190	500	190	1200	190	1200		
*Colorama 1 Alu	340	135	230	450	250	600	240	400	240	400	240	400	240	400	330	500	330	1000	300	1200		
Colorama 2	200	140	230	600	230	600	230	400	230	400	240	400	280	500	280	500	280	1200	230	1200		
*Colorama 2 Alu	340	250	190	600	190	600	190	400	190	400	190	400	190	500	190	500	190	1200	190	1200		
Colorama 2 Bioactive	290	255	280	600	280	600	230	310	220	320	240	400	240	400	280	500	280	1200	230	1200		
Deep	200	290	190	600	190	600	190	350	190	350	190	400	190	500	190	500	190	1200	190	1200		
Deep	290	325	280	600	280	600	240	230	160	390	240	400	240	400	280	500	280	1200	230	1200		
<b>Dualscreen 1%</b>	250	450	500	300	250	600	240	165	165	270	240	400	240	400	300	500	300	500	500	720		
<b>Dualscreen 3%</b>	250	430	500	300	250	600	240	175	170	270	240	400	240	400	300	500	300	500	500	720		
<b>Dualscreen 5%</b>	250	410	330	450	250	600	240	180	155	320	240	400	240	400	300	500	300	500	500	720		
Ecoscreen	325	270	315	475	250	600	240															





# Dim-out Roller Blinds

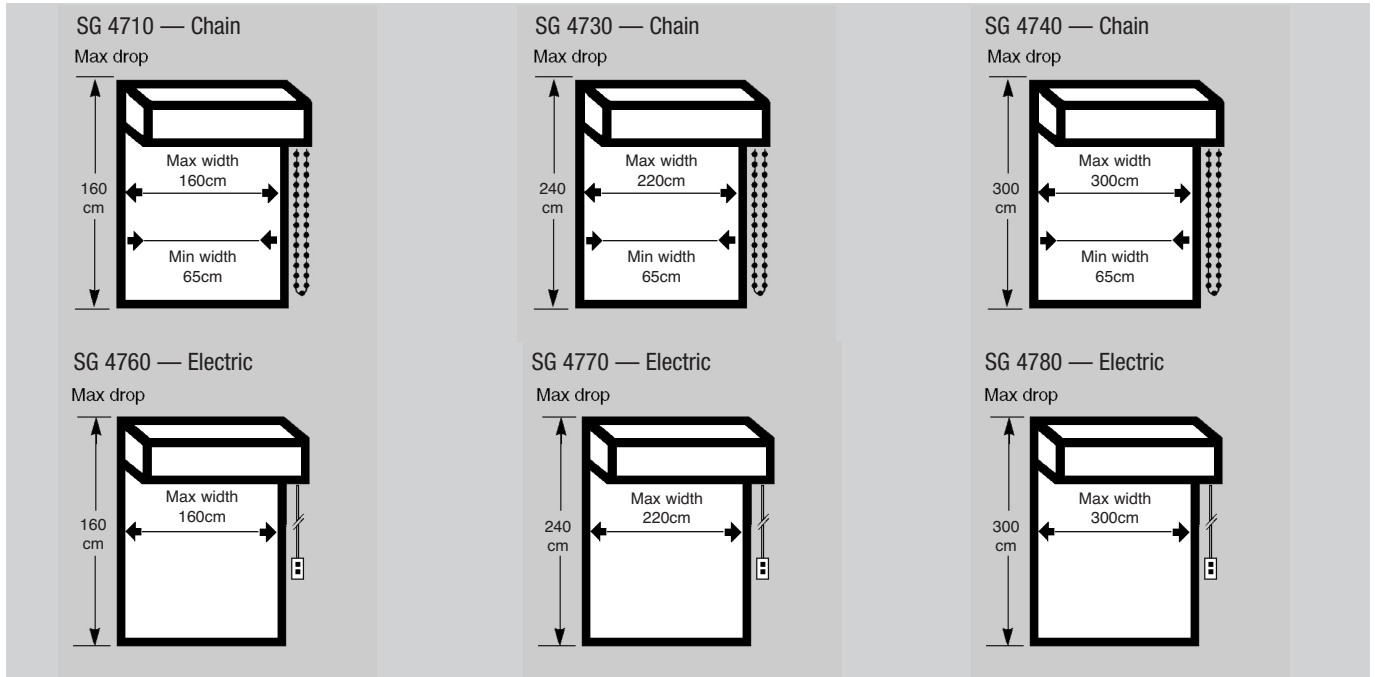

Price category C

The prices in the tables comprise the complete system made-to-measure, with fabric chosen, ready to install.

If sizes lie between the measurements shown, the price for the next larger size will apply.

**Colours:** White or black available as standard.  
Standard RAL colours are available at extra cost as follows:-  
£59.50/m width Price cat. 'C'  
£59.50/m drop Price cat. 'C'

Delivery: 4 weeks.

Charges are for headrail/side legs — + bottom rails only, accessories available in white or black only.

**Note:** Laminated customer own fabric not available.  
\* If welded, white not recommended as discolours.

## SG 4710 - Chain (Headbox size: 73mm)

### Price Group 1R

Puma

Width	65cm	80cm	100cm	120cm	140cm	160cm	Width
Drop (cm)							Drop (cm)
60	238.85	256.00	278.81	301.69	324.56	347.38	60
80	258.96	276.11	298.93	321.80	344.68	367.49	80
100	279.08	296.23	319.04	341.92	364.80	387.61	100
120	299.19	316.34	339.16	362.03	384.91	407.73	120
140	319.31	336.46	359.27	382.15	405.03	427.84	140
160	339.43	356.58	379.39	402.27	425.14	447.96	160

### Price Group 2R

Basic Screen 5%  
Mercurio B  
Nox

Width	65cm	80cm	100cm	120cm	140cm	160cm	Width
Drop (cm)							Drop (cm)
60	321.21	338.34	361.22	384.05	406.91	429.79	60
80	351.65	368.79	391.62	414.48	437.31	460.18	80
100	382.04	399.19	422.05	444.88	467.75	490.57	100
120	412.48	429.62	452.45	475.32	498.14	521.02	120
140	442.88	460.02	482.89	505.71	528.59	551.40	140
160	473.26	490.40	513.28	536.10	558.97	581.85	160

### Price Group 3R

Moon  
Lightscreen

Width	65cm	80cm	100cm	120cm	140cm	160cm	Width
Drop (cm)							Drop (cm)
60	378.15	395.30	418.17	441.05	463.87	486.74	60
80	415.71	432.85	455.72	478.54	501.41	524.29	80
100	453.24	470.39	493.26	516.08	538.96	561.77	100
120	490.78	507.92	530.75	553.63	576.49	599.32	120
140	528.34	545.48	568.29	591.17	613.99	636.86	140
160	565.82	582.96	605.84	628.71	651.53	674.40	160

All prices shown exclude VAT



# Dim-Out Roller Blind SG 4730 - Chain (Headbox size: 90mm)

Price category C

## Price Group 1R - Puma

Width	65cm	80cm	100cm	120cm	140cm	160cm	180cm	200cm	220cm	Width
Drop cm										Drop cm
60	285.25	303.63	328.13	352.68	377.18	401.67	426.17	450.66	475.16	60
80	305.36	323.75	348.24	372.80	397.29	421.79	446.28	470.78	495.27	80
100	325.48	343.87	368.36	392.91	417.41	441.90	466.40	490.89	515.39	100
120	345.60	363.98	388.47	413.03	437.52	462.02	486.51	511.01	535.50	120
140	365.71	384.10	408.59	433.15	457.64	482.13	506.63	531.12	555.62	140
160	385.83	404.21	428.71	453.26	477.76	502.25	526.75	551.24	575.74	160
180	405.94	424.33	448.82	473.32	497.82	522.31	546.81	571.30	595.80	180
200	426.06	444.45	468.94	493.43	517.93	542.42	566.92	591.41	615.91	200
220	446.18	464.56	489.05	513.55	538.04	562.54	587.03	611.53	636.02	220
240	466.29	484.68	509.17	533.66	558.16	582.65	607.15	631.64	656.14	240

## Price Group 2R - Basic Screen 5%, Mercurio B and Nox

Width	65cm	80cm	100cm	120cm	140cm	160cm	180cm	200cm	220cm	Width
Drop cm										Drop cm
60	367.66	386.04	410.54	435.03	459.53	484.03	508.52	533.02	557.51	60
80	398.04	416.43	440.93	465.43	489.92	514.42	538.91	563.41	587.90	80
100	428.42	446.81	471.31	495.81	520.30	544.80	569.30	593.79	618.29	100
120	458.80	477.19	501.69	526.18	550.68	575.18	599.67	624.17	648.67	120
140	489.18	507.57	532.07	556.56	581.06	605.56	630.05	654.55	679.05	140
160	519.56	537.95	562.45	586.94	611.44	635.93	660.43	684.92	709.42	160
180	550.00	568.39	592.89	617.38	641.88	666.37	690.87	715.36	739.86	180
200	580.44	598.83	623.33	647.82	672.32	696.81	721.31	745.81	770.30	200
220	610.88	629.27	653.77	678.26	702.76	727.25	751.75	776.24	800.74	220
240	641.32	659.71	684.21	708.70	733.20	757.69	782.19	806.68	831.18	240

## Price Group 3R - Moon and Lightscreen

Width	65cm	80cm	100cm	120cm	140cm	160cm	180cm	200cm	220cm	Width
Drop cm										Drop cm
60	424.61	442.99	467.49	491.99	516.48	541.03	565.53	590.03	614.52	60
80	462.16	480.55	505.04	529.53	554.03	578.53	603.03	627.52	652.02	80
100	499.64	518.03	542.52	567.02	591.51	616.01	640.51	665.00	689.50	100
120	537.19	555.57	580.07	604.56	629.06	653.56	678.05	702.55	727.04	120
140	574.73	593.12	617.61	642.11	666.61	691.10	715.60	740.10	764.59	140
160	612.27	630.66	655.15	679.65	704.14	728.64	753.14	777.63	802.13	160
180	649.82	668.21	692.70	717.20	741.69	766.19	790.68	815.18	839.67	180
200	687.36	705.75	730.24	754.74	779.23	803.73	828.22	852.72	877.21	200
220	724.84	743.23	767.72	792.22	816.71	841.21	865.70	890.20	914.69	220
240	762.40	780.78	805.27	829.77	854.26	878.76	903.25	927.75	952.24	240

# Dim-Out Roller Blind SG 4740 - Chain (Headbox size: 110mm)

Price category C

## Price Group 1R - Puma

Width	65cm	80cm	100cm	120cm	140cm	160cm	180cm	200cm	220cm	240cm	260cm	280cm	300cm	Width
Drop cm														Drop cm
60	377.94	401.24	432.28	463.37	494.41	525.44	556.47	587.50	618.54	649.57	680.60	711.64	742.67	60
80	397.62	420.92	451.96	483.05	514.09	545.13	576.16	607.20	638.23	669.27	700.30	731.34	762.37	80
100	417.30	440.60	471.65	502.68	533.78	564.81	595.84	626.87	657.90	688.93	720.00	751.03	782.06	100
120	436.99	460.29	491.33	522.36	553.40	584.43	615.46	646.49	677.52	708.55	739.58	770.61	801.64	120
140	456.67	479.97	511.01	542.05	573.14	604.18	635.21	666.24	697.27	728.30	759.33	790.36	821.39	140
160	476.35	499.65	530.70	561.73	592.83	623.86	654.89	685.92	716.95	747.98	779.01	810.04	841.07	160
180	496.04	519.34	550.38	581.41	612.51	643.54	674.57	705.60	736.63	767.66	798.69	829.72	860.75	180
200	515.72	539.02	570.06	601.10	632.19	663.23	694.26	725.29	756.32	787.35	818.38	849.41	880.44	200
220	535.40	558.70	589.75	620.78	651.88	682.91	713.94	744.97	776.00	807.03	838.06	869.09	900.12	220
240	555.09	578.39	609.43	640.46	671.56	702.59	733.62	764.65	795.68	826.71	857.74	888.77	919.80	240
260	574.77	598.07	629.11	660.15	691.24	722.28	753.31	784.34	815.37	846.40	877.43	908.46	939.49	260
280	594.45	617.75	648.80	679.83	710.88	741.96	773.00	804.03	835.06	866.09	897.12	928.15	959.18	280
300	614.14	637.44	668.48	699.51	730.56	761.64	792.67	823.70	854.73	885.76	916.79	947.82	978.85	300

## Price Group 2R - Basic Screen 5% (up to 300cm), Mercurio B and Nox (up to 260cm)

Width	65cm	80cm	100cm	120cm	140cm	160cm	180cm	200cm	220cm	240cm	260cm	280cm	300cm	Width
Drop cm														Drop cm
60	426.33	452.50	487.32	522.15	556.97	591.80	626.62	661.45	696.27	731.10	765.93	800.75	835.58	60
80	456.77	482.89	517.72	552.54	587.42	622.24	657.07	691.90	726.73	761.55	796.38	831.20	866.03	80
100	487.16	513.28	548.16	582.98	617.80	652.63	687.45	722.28	757.10	791.92	826.75	861.57	896.40	100
120	517.61	543.73	578.55	613.38	648.20	683.02	717.84	752.67	787.49	822.31	857.13	891.95	926.78	120
140	548.00	574.11	608.94	643.82	678.65	713.47	748.30	783.12	817.95	852.77	887.60	922.42	957.25	140
160	578.39	604.56	639.38	674.21	709.03	743.86	778.69	813.51	848.34	883.17	918.00	952.82	987.65	160
180	608.83	634.95	669.78	704.60	739.48	774.30	809.13	843.95	878.78	913.60	948.43	983.25	1018.08	180
200	639.22	665.34	700.21	735.04	769.86	804.69	839.51	874.34	909.16	943.99	978.81	1013.64	1048.46	200
220	669.66	695.79	730.61	765.43	800.26	835.13	869.96	904.78	939.61	974.43	1009.26	1044.08	1078.91	220
240	700.06	726.17	760.99	795.88	830.71	865.53	900.35	935.18	969.99	1004.82	1039.64	1074.47	1109.30	240
260	730.45	756.62	791.44	826.27	861.09	895.91	930.73	965.55	1000.38	1035.20	1070.02	1104.85	1139.67	260
280	760.89	787.01	821.84	856.66	891.54	926.36	961.19	996.01	1030.84	1065.66	1100.48	1135.31	1170.13	280
300	791.28	817.40	852.27	887.10	921.92	956.75	991.58	1026.40	1061.23	1096.05	1130.88	1165.70	1200.53	300

## Price Group 3R - Moon and Lightscreen

Width	65cm	80cm	100cm	120cm	140cm	160cm	180cm	200cm	220cm	240cm	260cm	280cm	300cm	Width
Drop cm														Drop cm
60	517.31	540.60	571.64	602.67	633.72	664.75	695.85	726.89	757.93	788.97	819.99	851.02	882.04	60
80	554.42	577.67	608.75	639.79	670.83	701.87	732.91	763.95	794.99	826.03	857.06	888.09	919.13	80
100	591.48	614.77	645.81	676.90	707.94	738.97	770.02	801.05	832.09	863.12	894.16	925.19	956.23	100
120	628.59	651.88	682.91	713.95	745.05	776.08	807.13	838.16	869.19	900.22	931.25	962.28	993.31	120
140	665.70	688.99	720.03	751.07	782.11	813.21	844.24	875.28	906.32	937.35	968.38	1000.00	1031.62	140
160	702.80	726.10	757.13	788.18	819.21	850.25	881.35	912.38	943.43	974.46	1005.49	1036.52	1067.55	160
180	739.92	763.16	794.25	825.30	856.33	887.38	918.41	949.51	980.54	1011.57	1042.60	1073.63	1104.66	180
200	776.97	800.27	831.30	862.40	893.44	924.48	955.52	986.55	1017.58	1048.61	1079.64	1110.67	1141.70	200
220	814.09	837.37	868.41	899.45	930.54	961.59	992.62	1023.67	1054.70	1085.73	1116.76	1147.79	1178.82	220
240														



## Dim-Out Roller Blind SG 4760 - Electric (Headbox size: 73mm)

Price category C

### Price Group 1R - Puma

Width	65cm	80cm	100cm	120cm	140cm	160cm	Width
Drop cm							Drop cm
60	780.89	804.89	836.84	868.87	900.89	932.84	60
80	809.05	833.05	865.00	897.03	929.05	961.00	80
100	837.23	861.22	893.16	925.19	957.21	989.16	100
120	865.39	889.38	921.34	953.36	985.38	1017.32	120
140	893.55	917.54	949.50	981.52	1013.54	1045.49	140
160	921.71	945.70	977.66	1009.68	1041.70	1073.65	160

### Price Group 2R - Basic Screen 5%, Mercurio B and Nox

Width	65cm	80cm	100cm	120cm	140cm	160cm	Width
Drop cm							Drop cm
60	896.19	920.19	952.21	984.17	1016.19	1048.21	60
80	938.81	962.81	994.76	1026.79	1058.74	1090.76	80
100	981.36	1005.36	1037.39	1069.34	1101.36	1133.31	100
120	1023.98	1047.91	1079.93	1111.96	1143.91	1175.93	120
140	1066.53	1090.53	1122.47	1154.51	1186.53	1218.47	140
160	1109.08	1133.07	1165.11	1197.05	1229.07	1261.09	160

### Price Group 3R - Moon and Lightscreen

Width	65cm	80cm	100cm	120cm	140cm	160cm	Width
Drop cm							Drop cm
60	975.88	999.88	1031.91	1063.93	1095.87	1127.90	60
80	1028.44	1052.44	1084.47	1116.41	1148.43	1180.46	80
100	1081.00	1104.99	1137.02	1168.96	1200.98	1232.93	100
120	1133.55	1157.54	1189.49	1221.51	1253.53	1285.48	120
140	1186.11	1210.11	1242.05	1274.07	1306.02	1338.04	140
160	1238.58	1262.57	1294.60	1326.62	1358.57	1390.59	160

System Control Options – Radio control standard option is with System 0450, see page 28.

Series 40 motors – With integrated radio receiver for operation with SG wireless system 9940 – add on £195.00 per system, see page 28.

SMART by Silent Gliss motors – for use with Silent Gliss Gateway and associated components – add on £195.00 per system, see page 28.

## Dim-Out Roller Blind SG 4770 - Electric (Headbox size: 90mm)

Price category C

### Price Group 1R - Puma

Width	65cm	80cm	100cm	120cm	140cm	160cm	180cm	200cm	220cm	Width
Drop cm										Drop cm
60	789.61	815.35	849.64	883.94	918.22	952.60	1139.06	1173.36	1207.64	60
80	817.77	843.51	877.80	912.10	946.38	980.76	1186.22	1220.52	1254.81	80
100	845.93	871.67	905.96	940.26	974.56	1008.92	1233.38	1267.68	1301.97	100
120	874.09	899.83	934.13	968.42	1002.72	1037.09	1280.55	1314.85	1349.22	120
140	902.25	927.99	962.29	996.58	1030.88	1065.25	1327.71	1362.08	1396.38	140
160	930.42	956.16	990.45	1024.75	1059.04	1093.41	1374.96	1409.25	1443.55	160
180	958.58	984.32	1018.61	1052.91	1087.20	1121.57	1422.12	1456.41	1490.71	180
200	986.74	1012.48	1046.77	1081.07	1115.37	1149.73	1469.28	1503.57	1537.87	200
220	1014.90	1040.64	1074.94	1109.23	1143.53	1177.82	1516.45	1550.74	1585.11	220
240	1043.06	1068.80	1103.10	1137.39	1171.69	1205.99	1563.61	1597.98	1632.27	240

### Price Group 2R - Basic Screen 5%, Mercurio B and Nox

Width	65cm	80cm	100cm	120cm	140cm	160cm	180cm	200cm	220cm	Width
Drop cm										Drop cm
60	904.91	930.65	964.93	999.31	1033.61	1067.89	1102.19	1183.35	1217.64	60
80	947.53	973.27	1007.56	1041.86	1076.14	1110.44	1144.81	1231.73	1266.09	80
100	990.07	1015.81	1050.11	1084.39	1118.77	1153.06	1187.35	1280.18	1314.47	100
120	1032.69	1058.36	1092.73	1127.02	1161.31	1195.61	1229.90	1328.63	1362.92	120
140	1075.24	1100.98	1135.28	1169.57	1203.86	1238.24	1272.52	1377.00	1411.37	140
160	1117.79	1143.53	1177.82	1212.19	1246.49	1280.77	1315.07	1425.45	1459.75	160
180	1160.41	1186.15	1220.44	1254.74	1289.02	1323.32	1357.69	1473.90	1508.20	180
200	1202.96	1228.70	1262.99	1297.29	1331.66	1365.94	1400.24	1522.28	1556.65	200
220	1245.58	1271.24	1305.61	1339.91	1374.20	1408.49	1442.78	1570.73	1605.02	220
240	1288.12	1313.86	1348.16	1382.45	1416.74	1451.12	1485.40	1619.18	1653.47	240

### Price Group 3R - Moon and Lightscreen

Width	65cm	80cm	100cm	120cm	140cm	160cm	180cm	200cm	220cm	Width
Drop cm										Drop cm
60	984.66	1010.33	1044.70	1078.99	1113.29	1147.58	1181.87	1216.24	1250.54	60
80	1037.15	1062.89	1097.19	1131.55	1165.85	1200.15	1234.43	1268.73	1303.10	80
100	1089.70	1115.44	1149.73	1184.03	1218.40	1252.69	1286.99	1321.28	1355.57	100
120	1142.25	1167.99	1202.28	1236.58	1270.88	1305.24	1339.54	1373.83	1408.12	120
140	1194.81	1220.55	1254.84	1289.14	1323.44	1357.73	1392.10	1426.40	1460.68	140
160	1247.36	1273.02	1307.39	1341.69	1375.98	1410.28	1444.58	1478.94	1513.23	160
180	1299.84	1325.58	1359.88	1394.25	1428.54	1462.84	1497.14	1531.42	1565.80	180
200	1352.39	1378.13	1412.43	1446.73	1481.09	1515.39	1549.69	1583.98	1618.27	200
220	1404.94	1430.68	1464.98	1499.27	1533.57	1567.94	1602.23	1636.53	1670.82	220
240	1457.50	1483.24	1517.54	1551.83	1586.13	1620.43	1654.79	1689.09	1723.39	240

System Control Options – Radio control standard option is with System 0450, see page 28.

Series 40 motors – With integrated radio receiver for operation with SG wireless system 9940 – add on £195.00 per system, see page 28.

SMART by Silent Gliss motors – for use with Silent Gliss Gateway and associated components – add on £195.00 per system, see page 28.

All prices shown exclude VAT



# Dim-Out Roller Blind SG 4780 - Electric (Headbox size: 110mm)

Price category C

## Price Group 1R - Puma

Width	65cm	80cm	100cm	120cm	140cm	160cm	180cm	200cm	220cm	240cm	260cm	280cm	300cm	Width
Drop cm														Drop cm
60	912.80	946.47	991.35	1036.25	1081.22	1126.11	1323.17	1368.07	1412.95	1457.85	1502.82	1547.71	1592.61	60
80	940.96	974.63	1019.51	1064.41	1109.38	1154.27	1370.33	1415.23	1460.12	1505.09	1549.99	1594.87	1639.77	80
100	969.12	1002.79	1047.69	1092.57	1137.54	1182.44	1417.50	1462.39	1507.36	1552.25	1597.15	1642.05	1686.93	100
120	997.29	1030.95	1075.85	1120.73	1165.70	1210.60	1464.66	1509.63	1554.53	1599.41	1644.31	1689.21	1734.17	120
140	1025.45	1059.12	1104.01	1148.90	1193.87	1238.76	1511.91	1556.79	1601.69	1646.59	1691.48	1736.45	1781.34	140
160	1053.61	1087.28	1132.17	1177.06	1222.03	1266.92	1559.07	1603.96	1648.85	1693.75	1738.71	1783.61	1828.51	160
180	1081.77	1115.44	1160.33	1205.22	1250.12	1295.08	1606.23	1651.13	1696.02	1740.99	1785.89	1830.77	1875.67	180
200	1109.93	1143.60	1188.50	1233.38	1278.28	1323.25	1653.40	1698.29	1743.25	1788.15	1833.05	1877.94	1922.83	200
220	1138.10	1171.76	1216.66	1261.54	1306.44	1351.41	1700.56	1745.53	1790.43	1835.32	1880.21	1925.10	1970.07	220
240	1166.26	1199.93	1244.82	1289.71	1334.60	1379.57	1747.80	1792.69	1837.59	1882.48	1927.38	1972.35	2017.23	240
260	1194.42	1228.09	1272.98	1317.87	1362.76	1407.73	1794.97	1839.86	1884.76	1929.64	1974.61	2019.51	2064.40	260
280	1222.58	1256.25	1301.14	1346.03	1390.93	1435.89	1842.13	1887.02	1931.92	1976.89	2021.78	2066.67	2111.56	280
300	1250.74	1284.41	1329.31	1374.20	1419.09	1464.06	1889.30	1934.19	1979.16	2024.05	2068.94	2113.84	2158.73	300

## Price Group 2R - Basic Screen 5% (up to 300cm), Mercurio B and Nox (up to 260cm)

Width	65cm	80cm	100cm	120cm	140cm	160cm	180cm	200cm	220cm	240cm	260cm	280cm	300cm	Width
Drop cm														Drop cm
60	1078.87	1115.44	1164.19	1212.95	1261.77	1310.53	1359.28	1408.04	1554.30	1603.05	1651.81	1700.63	1749.39	60
80	1110.22	1146.78	1195.53	1244.36	1293.11	1341.87	1390.62	1439.38	1597.83	1646.59	1695.41	1744.17	1792.92	80
100	1141.56	1178.20	1226.95	1275.71	1324.46	1373.22	1422.04	1470.80	1641.36	1690.19	1738.95	1787.70	1836.45	100
120	1172.97	1209.54	1258.29	1307.05	1355.80	1404.63	1453.38	1502.14	1684.97	1733.72	1782.48	1831.23	1879.99	120
140	1204.32	1240.88	1289.63	1338.39	1387.21	1435.97	1484.72	1533.48	1728.49	1777.25	1826.00	1874.75	1923.59	140
160	1235.66	1272.23	1320.98	1369.81	1418.56	1467.32	1516.07	1564.83	1772.02	1820.78	1869.53	1918.36	1967.11	160
180	1267.00	1303.57	1352.39	1401.15	1449.90	1498.66	1547.41	1596.24	1815.56	1864.31	1913.14	1961.89	2010.65	180
200	1298.42	1334.98	1383.73	1432.49	1481.24	1530.00	1578.83	1627.59	1859.09	1907.92	1956.67	2005.43	2054.18	200
220	1329.76	1366.33	1415.08	1463.84	1512.66	1561.42	1610.17	1658.93	1902.70	1951.45	2000.20	2048.96	2097.71	220
240	1361.10	1397.67	1446.42	1495.25	1544.00	1592.76	1641.51	1690.26	1946.23	1994.98	2043.74	2092.49	2141.32	240
260	1392.45	1429.01	1477.83	1526.59	1575.34	1624.10	1672.85	1721.69	1989.75	2038.50	2087.26	2136.10	2184.85	260
280	1423.78	1460.43	1509.18	1557.94	1606.69	1655.44	1704.27	1753.03	2033.28	2082.04	2130.86	2179.62	2228.37	280
300	1455.20	1491.77	1540.52	1589.28	1638.03	1686.86	1735.61	1784.37	2076.82	2125.64	2174.40	2223.15	2271.91	300

## Price Group 3R - Moon and Lightscreen

Width	65cm	80cm	100cm	120cm	140cm	160cm	180cm	200cm	220cm	240cm	260cm	280cm	300cm	Width
Drop cm														Drop cm
60	1107.79	1141.53	1186.42	1231.31	1276.20	1321.10	1366.07	1410.96	1455.85	1474.81	1790.57	1839.33	1888.08	60
80	1160.33	1194.01	1238.98	1283.87	1328.76	1373.66	1418.55	1463.52	1508.41	1527.35	1876.50	1925.26	1974.01	80
100	1212.89	1246.56	1291.46	1336.33	1381.31	1426.21	1471.10	1516.00	1560.97	1579.97	1962.43	2011.18	2059.94	100
120	1265.44	1299.11	1344.01	1388.89	1433.86	1478.76	1523.65	1568.55	1613.43	1632.50	2048.35	2097.10	2145.86	120
140	1318.00	1351.67	1396.57	1441.45	1486.35	1531.32	1576.21	1621.11	1665.99	1685.04	2134.20	2183.03	2231.78	140
160	1370.48	1404.22	1449.12	1494.00	1538.90	1583.79	1628.76	1673.66	1718.54	1737.58	2220.12	2268.96	2317.71	160
180	1423.03	1456.71	1501.68	1546.57	1591.46	1636.35	1681.25	1726.22	1771.11	1790.12	2306.05	2354.81	2403.64	180
200	1475.59	1509.26	1554.15	1599.12	1644.01	1688.90	1733.80	1778.69	1823.66	1842.66	2391.98	2440.73	2489.48	200
220	1528.14	1561.81	1606.70	1651.59	1696.56	1741.45	1786.35	1831.24	1876.13	1895.20	2477.90	2526.65	2575.41	220
240	1580.70	1614.37	1659.26	1704.16	1749.04	1794.01	1838.91	1883.80	1928.70	1947.74	2563.82	2612.58	2661.33	240
260	1633.18	1666.92	1711.81	1756.71	1801.59	1846.49	1891.46	1936.35	1981.25	2000.28	2649.75	2698.51	2747.26	260
280	1685.72	1719.40	1764.37	1809.27	1854.15	1899.05	1943.94	1988.91	2033.81	2052.82	2735.68	2784.43	2833.18	280
300	1738.28	1771.95	1816.85	1861.82	1906.71	1951.60	1996.49	2041.39	2086.36	2105.36	2821.53	2870.35	2919.11	300

System Control Options – Radio control standard option is with System 0450, see page 28.

Series 40 motors – With integrated radio receiver for operation with SG wireless system 9940 – add on £195.00 per system, see page 28.

SMART by Silent Gliss motors – for use with Silent Gliss Gateway and associated components – add on £195.00 per system, see page 28.

All prices shown exclude VAT



# Venetian Blinds

## Venetian Blind Slat Information

### Aluminium Slats

#### Price Group 1

Slat Reference	Slat Width (mm)	Slat Description
603	16	Natural Alu
612	16	Off White
613	16	Clear White
615	16	White

Slat Reference	Slat Width (mm)	Slat Description
648	16	Light Grey
650	16	Magnolia
706	25	Natural Alu
716	25	Off White

Slat Reference	Slat Width (mm)	Slat Description
718	25	Clear White
720	25	White
758	25	Light Grey
759	25	Light Grey

Slat Reference	Slat Width (mm)	Slat Description
761	25	Magnolia

#### Price Group 2

Slat Reference	Slat Width (mm)	Slat Description
601	16	Polished Alu
602	16	TRP Natural Silver
604	16	Bright Silver
609	16	Natural Silver
610	16	Natural Silver Matt
611	16	Light Ash
614	16	Pearl China White
616	16	Light Grey
617	16	Grey Flannel
618	16	Metal Grey

Slat Reference	Slat Width (mm)	Slat Description
619	16	Gloss Black
620	16	Black
624	16	Turkey Blue
651	16	Magnolia
703	25	Polished Alu
704	25	TRP Natural Silver
705	25	Alu Perforated
707	25	Bright Silver
712	25	Natural Silver
713	25	Natural Silver Matt

Slat Reference	Slat Width (mm)	Slat Description
714	25	Light Ash
715	25	White Perforated
719	25	Pearl China White
723	25	Light Grey
724	25	Grey Flannel
725	25	Metal Grey
726	25	Gloss Black
729	25	Black
733	25	Turkey Blue
760	25	Magnolia Perforated

Slat Reference	Slat Width (mm)	Slat Description
762	25	Magnolia
771	25	Glossy Red
773	25	Garnet Red

#### Price Group 3

Slat Reference	Slat Width (mm)	Slat Description
605	16	Bright Gold
607	16	Bright Bronze
608	16	Aluminium Gris
622	16	Indigo
625	16	Mount Baker
626	16	Morning Glory
627	16	Universe Blue
629	16	Fishing Blue
635	16	Hunter Green
646	16	Light Banana
652	16	Fawn
654	16	US Beige
655	16	Mud Pie
656	16	Dark Beige
702	25	Alu Perforated
708	25	Bright Gold
709	25	Caribou
710	25	Bright Bronze
711	25	Aluminium Gris
722	25	Grey Perforated
727	25	Black Perforated
728	25	Black
731	25	Indigo

Slat Reference	Slat Width (mm)	Slat Description
732	25	Admiral
734	25	Mount Baker
735	25	Morning Glory
736	25	Universe Blue
738	25	Fishing Blue
739	25	Greek Holiday
740	25	Light Laguna
745	25	Hunter Green
747	25	Green Aspen
748	25	Weeping Green
749	25	Grass Snake
751	25	Aztec
752	25	Saffron
754	25	Daffodil
756	25	Light Banana
757	25	Beaverwood
764	25	Fawn
765	25	Spun Gold
766	25	US Beige
767	25	Mud Pie
768	25	Dark Beige
769	25	Diamond Mine
777	25	Woodgrain Abbey





# Venetian Blinds

## SG 8110 (16mm)

Mono control Venetian Blind System.  
 Slats 16mm.  
 Maximum System Width: 2.5m  
 Minimum System Width: 28cm  
 Maximum System Drop: 2.5m  
 Maximum Surface Area: 5m<sup>2</sup>

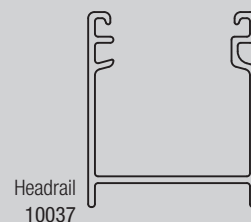
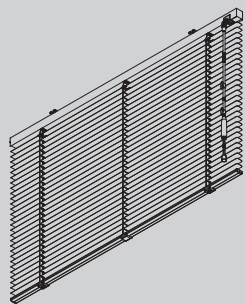

The prices in the tables below comprise the complete system made-to-measure with 16mm slats ready to hang. If sizes lie between the measurements shown, the price for the next size larger will apply. White control wands as standard (other colours available). The following wand sizes are available 225mm, 385mm, 585mm, 785mm, 985mm, 1185mm, 1385mm, 1585mm and 1800mm. For side guided version please add 20% to prices below.

### Price Group 1

Price Category C

Width Drop cm	60cm	80cm	100cm	120cm	140cm	160cm	180cm	200cm	220cm	240cm	250cm	Width Drop cm
60	156.35	170.87	185.40	199.94	214.49	229.02	243.55	258.09	272.62	287.19	294.43	60
80	161.01	177.07	193.11	209.15	225.21	241.25	257.30	273.34	289.37	305.44	313.44	80
100	165.69	183.24	200.79	218.38	235.91	253.46	271.01	288.58	306.13	323.68	332.46	100
120	170.37	189.43	208.49	227.56	246.62	265.70	284.76	303.82	322.87	341.94	351.49	120
140	175.03	195.60	216.17	236.72	257.32	277.90	298.47	319.06	339.61	360.21	370.50	140
160	179.70	201.77	223.87	245.93	268.03	290.11	312.20	334.31	356.39	378.46	389.52	160
180	184.36	207.98	231.56	255.14	278.74	302.35	325.93	349.52	373.13	396.73	408.51	180
200	189.02	214.15	239.24	264.35	289.47	314.56	339.67	364.76	389.89	414.99	427.53	200
220	193.71	220.32	246.91	273.55	300.16	326.79	353.41	380.01	406.63			220
240	198.37	226.49	254.64	282.72	310.88	338.99	367.11	395.24				240
260	200.72	229.58	258.47	287.33	316.23	345.12	373.98	402.87				260

### Price Group 2

Price Category C

Width Drop cm	60cm	80cm	100cm	120cm	140cm	160cm	180cm	200cm	220cm	240cm	250cm	Width Drop cm
60	161.49	177.74	198.07	210.24	226.48	242.74	258.97	275.22	291.49	307.73	315.85	60
80	167.87	186.20	204.53	222.84	241.20	259.53	277.85	296.18	314.52	332.84	342.02	80
100	174.26	194.66	215.08	235.49	255.90	276.34	296.71	317.14	337.54	357.96	368.16	100
120	180.63	203.12	225.64	248.11	270.59	293.12	315.59	338.08	360.58	383.08	394.31	120
140	187.02	211.59	236.18	260.73	285.31	309.89	334.46	359.02	383.59	408.17	420.48	140
160	193.39	220.06	246.72	273.36	300.02	326.66	353.34	379.99	406.65	433.30	446.61	160
180	199.80	228.53	257.26	285.98	314.72	343.47	372.20	400.93	429.66	458.41	472.79	180
200	206.16	237.00	267.80	298.62	329.44	360.25	391.07	421.90	452.71	483.51	498.95	200
220	212.56	245.45	278.36	311.27	344.13	377.04	409.95	442.84	475.74			220
240	218.92	253.91	288.88	323.87	358.85	393.82	428.82	463.77				240
260	222.11	258.13	294.16	330.19	366.21	402.22	438.24	474.26				260

### Price Group 3

Price Category C

Width Drop cm	60cm	80cm	100cm	120cm	140cm	160cm	180cm	200cm	220cm	240cm	250cm	Width Drop cm
60	173.74	191.84	209.92	228.01	246.10	264.17	282.25	300.34	318.42	336.52	345.57	60
80	181.39	201.96	222.52	243.11	263.68	284.27	304.82	325.41	345.99	366.57	376.84	80
100	188.99	212.09	235.14	258.21	281.28	304.35	327.42	350.48	373.55	396.62	408.15	100
120	196.62	222.18	247.74	273.32	298.88	324.44	349.99	375.56	401.13	426.69	439.47	120
140	204.26	232.32	260.36	288.40	316.47	344.52	372.59	400.64	428.70	456.74	470.76	140
160	211.87	242.45	272.96	303.51	334.08	364.61	395.17	425.70	456.24	486.80	502.07	160
180	219.49	252.55	285.57	318.62	351.64	384.69	417.72	450.77	483.81	516.86	533.39	180
200	227.12	262.66	298.20	333.72	369.26	404.77	440.34	475.85	511.38	546.92	564.69	200
220	234.75	272.79	310.79	348.83	386.86	424.86	462.89	500.93	538.96			220
240	232.83	282.92	323.43	363.94	404.46	444.96	485.47	525.99				240
260	246.19	287.95	329.72	371.47	413.26	455.00	496.77	538.51				260

All prices shown exclude VAT



# Venetian Blinds

## SG 8110PC (25mm)

Mono control Venetian Blind System.  
 Slats 25mm.  
 Maximum System Width: 3m  
 Minimum System Width: 28cm  
 Maximum System Drop: 5m  
 Maximum Surface Area: 7m<sup>2</sup>

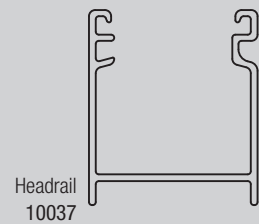
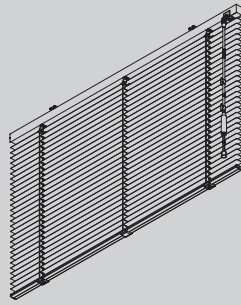

The prices in the tables below comprise the complete system made-to-measure with 25mm slats ready to hang. If sizes lie between the measurements shown, the price for the next size larger will apply. White control wands as standard (other colours available). The following wand sizes are available 225mm, 385mm, 585mm, 785mm, 985mm, 1185mm, 1385mm, 1585mm and 1800mm. For side guided version please add 20% to prices below.

### Price Group 1

Price Category C

Width Drop cm	60cm	80cm	100cm	120cm	140cm	160cm	180cm	200cm	220cm	240cm	260cm	280cm	300cm	Width Drop cm
60	158.52	173.69	188.87	204.02	219.18	234.35	249.53	264.71	279.85	295.03	310.21	325.38	340.53	60
80	163.42	180.12	196.83	213.52	230.22	246.92	263.64	280.32	297.04	313.75	330.47	347.19	363.87	80
100	168.29	186.53	204.78	223.04	241.27	259.53	277.75	295.98	314.23	332.47	350.70	368.97	387.21	100
120	173.18	192.95	212.75	232.52	252.32	272.07	291.87	311.65	331.41	351.18	370.96	390.76	410.55	120
140	178.06	199.40	220.70	242.03	263.36	284.64	305.97	327.29	348.60	369.92	391.24	412.57	433.86	140
160	182.97	205.81	228.66	251.51	274.38	297.23	320.07	342.95	365.80	388.64	411.49	434.33	457.21	160
180	187.87	212.24	236.63	261.03	285.41	309.78	334.20	358.57	382.98	407.39	431.75	456.15	480.53	180
200	192.75	218.67	244.59	270.52	296.46	322.37	348.30	374.23	400.16	426.09	452.01	477.95	503.86	200
220	197.63	225.08	252.56	280.03	307.49	334.96	362.40	389.89	417.34	444.81	472.26	499.71	527.18	220
240	202.51	231.51	260.52	289.53	318.52	347.51	376.52	405.53	434.52	463.54	492.52	521.52	550.52	240
260	207.40	237.95	268.48	299.04	329.57	360.08	390.65	421.17	451.71	482.25	512.76	543.33		260
280	212.28	244.38	276.44	308.54	340.60	372.65	404.73	436.79	468.91	500.96	533.03			280
300	217.18	250.78	284.40	318.00	351.61	385.24	418.87	452.46	486.08	519.69				300
320	222.08	257.24	292.38	327.50	362.67	397.82	432.96	468.09	503.27					320
340	226.97	263.64	300.34	337.03	373.70	410.38	447.05	483.77						340
360	231.87	270.08	308.29	346.51	384.73	422.96	461.18	499.41						360
380	236.72	276.48	316.26	356.03	395.78	435.53	475.29							380
400	241.63	282.94	324.19	365.51	406.80	448.10	489.40							400
420	246.51	289.34	332.18	375.03	417.84	460.67								420
440	251.41	295.77	340.16	384.52	428.88	473.25								440
460	256.28	302.19	348.11	394.02	439.92									460
480	261.20	308.64	356.07	403.52	450.95									480
500	266.11	315.06	364.04	413.01	462.00									500

### Price Group 2

Price Category C

Width Drop cm	60cm	80cm	100cm	120cm	140cm	160cm	180cm	200cm	220cm	240cm	260cm	280cm	300cm	Width Drop cm
60	163.81	180.74	197.71	214.62	231.56	248.50	265.43	282.34	299.30	316.23	333.16	350.11	367.02	60
80	170.47	189.53	208.58	227.66	246.72	265.78	284.84	303.89	322.95	342.02	361.08	380.13	399.21	80
100	177.12	198.32	219.49	240.68	261.88	283.05	304.24	325.41	346.57	367.79	388.97	410.15	431.33	100
120	183.78	207.09	230.39	253.71	277.04	300.34	323.63	346.95	370.26	393.58	416.89	440.19	463.52	120
140	190.44	215.88	241.30	266.73	292.19	317.60	343.03	368.48	393.91	419.35	444.78	470.23	495.67	140
160	197.08	224.65	252.23	279.77	307.33	334.90	362.47	390.01	417.59	445.16	472.69	500.26	527.83	160
180	203.73	233.42	263.11	292.81	322.48	352.18	381.84	411.55	441.25	470.93	500.60	530.30	559.99	180
200	210.41	242.20	274.04	305.85	337.64	369.47	401.28	433.09	464.90	493.35	528.53	560.34	592.15	200
220	217.06	250.99	284.93	318.86	352.79	386.74	420.68	454.62	488.56	522.50	556.42	590.35	624.30	220
240	223.72	259.77	295.84	331.92	367.95	404.04	440.09	476.16	512.20	548.30	584.35	620.41	656.48	240
260	230.36	268.57	306.74	344.94	383.11	421.31	459.48	497.69	535.86	574.06	612.25	650.43		260
280	237.03	277.33	317.65	357.97	398.27	438.60	478.91	519.23	559.53	599.83	640.16			280
300	243.68	286.11	328.55	370.98	413.41	455.86	498.30	540.74	583.19	625.62				300
320	250.33	294.89	339.47	384.05	428.57	473.12	517.72	562.29	606.83					320
340	256.96	303.66	350.36	397.05	443.74	490.41	537.12	583.81						340
360	263.63	312.46	361.26	410.07	458.91	507.69	556.52	605.33						360
380	270.29	321.22	372.18	423.12	474.06	525.00	575.95							380
400	276.93	330.02	383.08	436.13	489.22	542.27	595.32							400
420	283.60	338.79	394.00	449.19	504.37	559.56								420
440	290.25	347.57	404.88	462.18	519.53	576.84								440
460	296.92	356.36	415.79	475.24	534.67									460
480	303.55	365.12	426.70	488.26	549.82									480
500	310.22	373.92	437.61	501.30	565.00									500

All prices shown exclude VAT



# Venetian Blinds

## SG 8110PC (25mm)

Mono control Venetian Blind System.  
 Slats 25mm.  
 Maximum System Width: 3m  
 Minimum System Width: 28cm  
 Maximum System Drop: 5m  
 Maximum Surface Area: 7m<sup>2</sup>

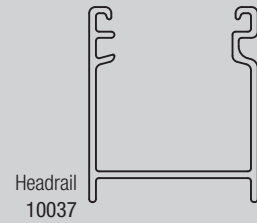
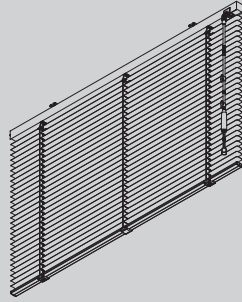

The prices in the table below comprise the complete system made-to-measure with 25mm slats ready to hang. If sizes lie between the measurements shown, the price for the next size larger will apply. White control wands as standard (other colours available). The following wand sizes are available 225mm, 385mm, 585mm, 785mm, 985mm, 1185mm, 1385mm, 1585mm and 1800mm. For side guided version please add 20% to prices below.

### Price Group 3 – 25mm slat size

Price Category C

Width Drop cm	60cm	80cm	100cm	120cm	140cm	160cm	180cm	200cm	220cm	240cm	260cm	280cm	300cm	Width Drop cm
60	178.92	200.86	222.83	244.82	266.77	288.73	310.70	332.69	354.67	376.61	398.58	420.55	442.51	60
80	190.59	216.36	242.13	267.90	293.66	319.45	345.20	370.98	396.75	422.50	448.30	474.07	499.84	80
100	202.28	231.87	261.44	291.00	320.60	350.16	379.73	409.28	438.86	468.44	498.01	527.58	557.15	100
120	213.96	247.34	280.72	314.09	347.47	380.85	414.22	447.60	480.99	514.36	547.71	581.12	614.49	120
140	225.67	262.85	300.02	337.19	374.36	411.55	448.75	485.92	523.10	560.25	597.44	634.60	671.80	140
160	237.34	278.35	319.31	360.30	401.28	442.26	483.22	524.21	565.19	606.17	647.17	688.13	729.12	160
180	249.04	293.82	338.62	383.38	428.17	472.96	517.74	562.51	607.30	652.08	696.87	741.66	786.44	180
200	260.70	309.31	357.90	406.47	455.07	503.66	552.24	600.85	649.39	697.99	746.60	795.16	843.77	200
220	272.40	324.81	377.19	429.57	481.98	534.38	586.73	639.13	691.51	743.92	796.29	848.70	901.09	220
240	284.08	340.29	396.50	452.67	508.86	565.05	621.24	677.45	733.63	789.82	846.00	902.23	958.39	240
260	295.77	355.78	415.76	475.79	535.76	595.74	655.75	715.74	775.74	835.74	895.73	955.73		260
280	307.48	371.25	435.06	498.86	562.66	626.46	690.24	754.04	817.85	881.65	945.45			280
300	319.17	386.75	454.36	521.95	589.63	657.14	724.76	792.36	859.95	927.57				300
320	330.85	402.24	473.66	545.06	616.46	687.84	759.27	830.67	902.05					320
340	342.54	417.72	492.93	568.16	643.36	718.55	793.76	868.96						340
360	354.23	433.24	512.23	591.23	670.27	749.26	828.27	907.29						360
380	365.91	448.73	531.52	614.34	697.15	779.96	862.77							380
400	377.60	464.21	550.82	637.45	724.04	810.65	897.28							400
420	389.28	479.69	570.12	660.54	750.94	841.37								420
440	400.95	495.19	589.40	683.60	777.86	872.06								440
460	412.65	510.68	608.70	706.72	804.72									460
480	424.33	526.19	627.98	729.82	831.63									480
500	436.03	541.65	647.28	752.92	858.55									500

All prices shown exclude VAT



# Venetian Blinds

## SG 8250 (16mm)

Electrically operated Venetian Blind System.  
 System with 24v motor 8060.  
 Maximum System Width: 300cm  
 Minimum System Width: 65cm\*  
 Maximum System Drop: 340cm  
 Maximum Surface Area: 5m<sup>2</sup>

\* Please refer to Catalogue pages

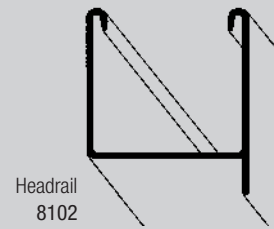
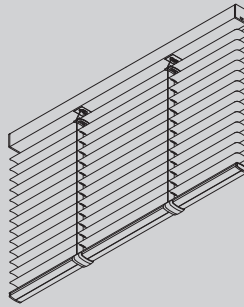

The prices in the tables below and on the following page comprise the complete system made-to-measure with 16mm and 25mm slats ready to hang with universal snap bracket 8201. If sizes lie between the measurements shown, the price for the next size larger will apply. For multicoloured blinds add 20% to prices below for each colour. For side-guided/sloping version add 20% to prices below.

### Price Group 1

Price Category C

Width Drop cm	80cm	100cm	120cm	140cm	160cm	180cm	200cm	220cm	240cm	260cm	280cm	300cm	Width Drop cm
60	630.41	660.62	690.82	721.01	751.25	781.44	811.63	841.85	872.06	902.27	932.46	962.68	60
80	637.53	669.31	701.04	732.82	764.59	796.31	828.07	859.84	891.57	923.36	955.10	986.85	80
100	644.67	677.98	711.26	744.60	777.89	811.20	844.55	877.81	911.14	944.42	977.73	1011.05	100
120	651.78	686.62	721.49	756.37	791.22	826.09	860.94	895.77	930.67	965.49	1000.36	1035.23	120
140	658.91	695.28	731.74	768.13	804.54	840.93	877.35	913.81	950.20	986.58	1023.01	1059.41	140
160	666.06	704.02	741.92	779.92	817.89	855.85	893.78	931.76	969.71	1007.69	1045.64	1083.59	160
180	673.14	712.68	752.17	791.71	831.21	870.70	910.22	949.75	989.27	1028.77			180
200	680.28	721.35	762.41	803.49	844.56	885.59	926.65	967.74	1008.80				200
220	687.39	730.00	772.65	815.23	857.87	900.47	943.07	985.69					220
240	694.53	738.72	782.85	827.00	871.16	915.37	959.55						240
260	701.65	747.37	793.08	838.81	884.51	930.24							260
280	708.78	756.04	803.31	850.55	897.84								280
300	715.90	764.73	813.52	862.35	911.20								300
320	723.00	773.40	823.74	874.12									320
340	730.16	782.05	833.97	885.93									340

### Price Group 2

Price Category C

Width Drop cm	80cm	100cm	120cm	140cm	160cm	180cm	200cm	220cm	240cm	260cm	280cm	300cm	Width Drop cm
60	640.38	673.03	705.73	738.42	771.09	803.77	836.46	869.18	901.85	934.51	967.20	999.89	60
80	648.71	683.26	717.81	752.35	786.92	821.46	856.01	890.55	925.08	959.65	994.17	1028.74	80
100	657.08	693.52	729.89	766.33	802.71	839.11	875.55	911.93	948.35	984.76	1021.15	1057.61	100
120	665.45	703.70	741.96	780.27	818.53	856.80	895.05	933.30	971.60	1009.88	1048.13	1086.43	120
140	673.82	713.94	754.05	794.19	834.29	874.44	914.60	954.76	994.90	1034.99	1075.13	1115.26	140
160	682.16	724.16	766.13	808.16	850.13	892.13	934.14	976.13	1018.13	1060.12	1102.10	1144.09	160
180	690.51	734.39	778.26	822.12	865.96	909.80	953.66	997.50	1041.40	1085.22			180
200	698.90	744.62	790.34	836.04	881.76	927.47	973.17	1018.90	1064.65				200
220	707.26	754.84	802.40	850.02	897.56	945.16	992.73	1040.34					220
240	715.63	765.07	814.50	863.94	913.38	962.81	1012.27						240
260	724.01	775.29	826.56	877.92	929.18	980.50							260
280	732.37	785.54	838.73	891.86	945.01								280
300	740.72	795.74	850.79	905.78	960.83								300
320	749.09	806.00	862.83	919.73									320
340	757.45	816.21	874.93	933.71									340

### Price Group 3

Price Category C

Width Drop cm	80cm	100cm	120cm	140cm	160cm	180cm	200cm	220cm	240cm	260cm	280cm	300cm	Width Drop cm
60	666.00	699.96	733.95	767.95	801.94	835.94	869.91	903.96	937.91	971.91	1005.88	1039.90	60
80	674.66	710.59	746.49	782.45	818.40	854.34	890.23	926.17	962.10	998.04	1033.97	1069.90	80
100	683.38	721.27	759.08	796.98	834.84	872.67	910.56	948.40	986.30	1024.14	1062.00	1099.91	100
120	692.07	731.87	771.63	811.48	851.28	891.05	930.87	970.65	1010.47	1050.27	1090.05	1129.89	120
140	700.75	742.51	784.23	825.98	867.70	909.42	951.19	992.94	1034.68	1076.36	1118.13	1159.87	140
160	709.46	753.15	796.79	840.49	884.17	927.80	971.53	1015.16	1058.85	1102.53	1146.20	1189.87	160
180	718.14	763.76	809.36	854.98	900.61	946.22	991.81	1037.42	1083.05	1128.63			180
200	726.84	774.37	821.96	869.50	917.06	964.57	1012.10	1059.65	1107.23				200
220	735.55	785.00	834.51	883.99	933.48	982.95	1032.42	1081.94					220
240	744.27	795.69	847.09	898.52	949.94	1001.32	1052.76						240
260	752.95	806.28	859.64	913.00	966.36	1019.71							260
280	761.67	816.94	872.26	927.52	982.80								280
300	770.37	827.55	884.81	942.04	999.24								300
320	779.05	838.21	897.35	956.51									320
340	787.75	848.85	909.94	971.08									340

Supplied with standard rocker switch. Programmable rocker switch (0937) available as an optional accessory.

All prices shown exclude VAT



# Venetian Blinds

## SG 8250 (25mm)

Electrically operated Venetian Blind System.  
System with 24v motor 8060.

Maximum System Width: 300cm  
Minimum System Width: 65cm\*  
Maximum System Drop: 340cm  
Maximum Surface Area: 5m<sup>2</sup>

\* Please refer to Catalogue pages

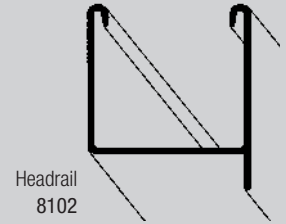
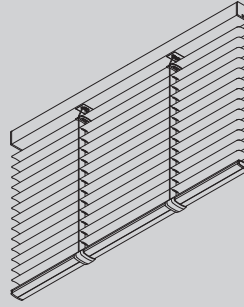

### Price Group 1

### Price Category C

Width Drop cm	80cm	100cm	120cm	140cm	160cm	180cm	200cm	220cm	240cm	260cm	280cm	300cm	Width Drop cm
60	618.80	646.49	674.20	701.93	729.59	757.30	785.02	812.73	840.46	868.16	895.84	923.57	60
80	624.20	653.12	682.00	710.92	739.83	768.75	797.66	826.56	855.50	884.41	913.33	942.20	80
100	629.58	659.72	689.84	719.93	750.09	780.19	810.31	840.45	870.53	900.68	930.75	960.94	100
120	635.00	666.33	697.65	728.98	760.29	791.64	822.94	854.30	885.59	916.91	948.26	979.59	120
140	640.42	672.92	705.45	737.98	770.51	803.05	835.58	868.14	900.66	933.18	965.74	998.23	140
160	645.79	679.54	713.28	747.04	780.76	814.49	848.21	881.95	915.72	949.43	983.17	1016.92	160
180	651.20	686.13	721.07	756.04	790.99	825.95	860.86	895.78	930.74	965.71			180
200	656.58	692.77	728.93	765.06	801.23	837.36	873.47	909.65	945.80				200
220	662.00	699.37	736.73	774.08	811.43	848.79	886.14	923.50					220
240	667.36	705.95	744.54	783.12	821.66	860.24	898.76						240
260	672.78	712.58	752.35	792.11	831.89	871.67							260
280	678.17	719.21	760.16	801.15	842.12								280
300	683.60	725.80	768.00	810.18	852.35								300
320	689.03	732.42	775.79	819.17									320
340	694.38	739.01	783.59	828.23									340

### Price Group 2

### Price Category C

Width Drop cm	80cm	100cm	120cm	140cm	160cm	180cm	200cm	220cm	240cm	260cm	280cm	300cm	Width Drop cm
60	626.52	656.13	685.78	715.45	745.07	774.68	804.35	833.96	863.62	893.25	922.87	952.51	60
80	632.88	663.99	695.01	726.16	757.21	788.29	819.39	850.48	881.56	912.62	943.74	974.80	80
100	639.25	671.78	704.30	736.83	769.36	801.91	834.46	866.94	899.52	932.04	964.55	997.07	100
120	645.62	679.60	713.56	747.55	781.53	815.51	849.48	883.48	917.49	951.44	985.42	1019.41	120
140	651.98	687.39	722.86	758.26	793.69	829.12	864.55	899.97	935.40	970.83	1006.27	1041.70	140
160	658.36	695.22	732.09	768.97	805.85	842.72	879.62	916.45	953.36	990.23	1027.11	1063.98	160
180	664.71	703.02	741.33	779.70	818.00	856.34	894.65	932.96	971.31	1009.61			180
200	671.08	710.84	750.58	790.39	830.18	869.93	909.68	949.48	989.26				200
220	677.43	718.66	759.87	801.10	842.30	883.54	924.78	965.98					220
240	683.80	726.45	769.15	811.83	854.44	897.15	939.80						240
260	690.18	734.27	778.40	822.54	866.63	910.72							260
280	696.54	742.15	787.67	833.25	878.78								280
300	702.92	749.92	796.94	843.92	890.96								300
320	709.26	757.75	806.19	854.67									320
340	715.64	765.53	815.44	865.36									340

### Price Group 3

### Price Category C

Width Drop cm	80cm	100cm	120cm	140cm	160cm	180cm	200cm	220cm	240cm	260cm	280cm	300cm	Width Drop cm
60	641.95	675.47	708.97	742.48	775.95	809.45	842.91	876.41	909.95	943.44	976.94	1010.43	60
80	650.24	685.67	721.08	756.55	791.97	827.40	862.81	898.25	933.70	969.14	1004.55	1039.96	80
100	658.55	695.90	733.27	770.63	807.97	845.35	882.72	920.05	957.36	994.80	1032.11	1069.48	100
120	666.83	706.17	745.42	784.72	824.01	863.32	902.58	941.84	981.12	1020.46	1059.74	1099.03	120
140	675.14	716.38	757.57	798.78	840.03	881.24	922.47	963.68	1004.92	1046.10	1087.32	1128.56	140
160	683.46	726.60	769.73	812.90	856.04	899.16	942.37	985.49	1028.64	1071.76	1114.95	1158.08	160
180	691.75	736.81	781.89	826.97	872.06	917.14	962.23	1007.30	1052.38	1097.43			180
200	700.01	747.06	794.06	841.06	888.09	935.08	982.07	1029.10	1076.10				200
220	708.32	757.28	806.20	855.13	904.11	953.04	1001.97	1050.90					220
240	716.61	767.49	818.36	869.25	920.09	970.99	1021.86						240
260	724.94	777.72	830.54	883.31	936.15	988.93							260
280	733.22	787.95	842.68	897.40	952.14								280
300	741.53	798.17	854.83	911.50	968.17								300
320	749.78	808.39	866.99	925.61									320
340	758.11	818.64	879.12	939.69									340

All prices shown exclude VAT





# Venetian Blinds

## SG 8300 (16mm)

Mono control Venetian Blind System.

Slats 16mm.

Maximum System Width: 3m

Minimum System Width: 50cm

Maximum System Drop: 3m

Maximum Surface Area: 4.5m<sup>2</sup>

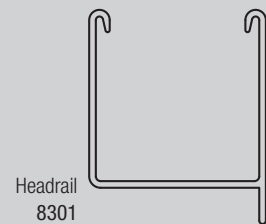
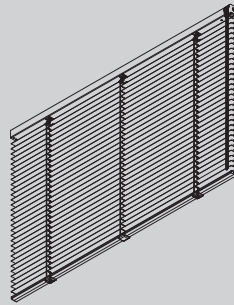

The prices in the tables below comprise the complete system made-to-measure with 16mm slats ready to hang. If sizes lie between the measurements shown, the price for the next size larger will apply. For side-guide or sloping add 20%.

### Price Group 1

Price Category C

Width Drop cm	60cm	80cm	100cm	120cm	140cm	160cm	180cm	200cm	220cm	240cm	260cm	280cm	300cm	Width Drop cm
60	162.05	178.13	194.21	210.30	226.40	242.48	258.55	274.67	290.73	306.81	322.92	338.99	355.10	60
80	166.72	184.36	202.00	219.66	237.30	254.96	272.58	290.25	307.91	325.53	343.20	360.83	378.47	80
100	171.38	190.59	209.82	229.02	248.22	267.43	286.64	305.86	325.05	344.25	363.46	382.68	401.86	100
120	176.07	196.86	217.60	238.38	259.15	279.90	300.68	321.45	342.21	362.97	383.75	404.51	425.28	120
140	180.74	203.09	225.39	247.74	270.07	292.39	314.72	337.04	359.36	381.72	404.04	426.35	448.67	140
160	185.44	209.34	233.21	257.09	280.99	304.86	328.77	352.64	376.52	400.42	424.30	448.17	472.06	160
180	190.11	215.57	241.00	266.44	291.91	317.34	342.78	368.24	393.68	419.13	444.58			180
200	194.80	221.82	248.79	275.80	302.81	329.82	356.83	383.83	410.83	437.83				200
220	199.46	228.05	256.60	285.20	313.73	342.30	370.87	399.44	428.02					220
240	204.15	234.28	264.39	294.54	324.67	354.76	384.93	415.03						240
260	208.85	240.53	272.20	303.89	335.57	367.26	398.95							260
280	213.52	246.77	280.02	313.24	346.49	379.75								280
300	218.21	253.01	287.80	322.63	357.42	392.22								300'

### Price Group 2

Price Category C

Width Drop cm	60cm	80cm	100cm	120cm	140cm	160cm	180cm	200cm	220cm	240cm	260cm	280cm	300cm	Width Drop cm
60	167.17	184.97	202.80	220.58	238.38	256.16	273.98	291.79	309.59	327.40	345.18	362.99	380.80	60
80	173.57	193.51	213.44	233.38	253.30	273.24	293.17	313.08	333.03	352.97	372.88	392.82	412.74	80
100	179.96	202.03	224.10	246.15	268.22	290.27	312.32	334.40	356.47	378.51	400.58	422.66	444.70	100
120	186.37	210.54	234.74	258.94	283.12	307.31	331.53	355.71	379.88	404.10	428.28	452.48	476.68	120
140	192.76	219.09	245.41	271.71	298.05	324.38	350.69	377.03	403.35	429.66	455.99	482.32	508.68	140
160	199.15	227.60	256.06	284.52	312.97	341.39	369.87	398.33	426.78	455.23	483.71	512.15	540.61	160
180	205.54	236.14	266.70	297.31	327.87	358.46	389.05	419.63	450.21	480.79	511.40			180
200	211.91	244.64	277.36	310.09	342.80	375.52	408.25	440.95	473.67	506.39				200
220	218.31	253.15	288.03	322.86	357.72	392.55	427.41	462.27	497.12					220
240	224.74	261.68	298.68	335.65	372.63	409.62	446.58	483.56						240
260	231.10	270.21	309.32	348.44	387.55	426.66	465.77							260
280	237.51	278.74	319.96	361.23	402.46	443.70								280
300	243.89	287.27	330.64	374.02	417.38	460.77								300'

### Price Group 3

Price Category C

Width Drop cm	60cm	80cm	100cm	120cm	140cm	160cm	180cm	200cm	220cm	240cm	260cm	280cm	300cm	Width Drop cm
60	179.79	199.52	219.24	238.96	258.71	278.42	298.15	317.89	337.59	357.34	377.07	396.78	416.53	60
80	187.44	209.69	231.96	254.27	276.49	298.79	321.08	343.33	365.61	387.88	410.15	432.44	454.71	80
100	195.06	219.88	244.72	269.52	294.34	319.17	343.98	368.79	393.61	418.44	443.26	468.05	492.89	100
120	202.70	230.06	257.41	284.80	312.15	339.52	366.91	394.24	421.60	448.97	476.33	503.72	531.06	120
140	210.33	240.23	270.16	300.07	329.98	359.90	389.78	419.68	449.63	479.53	509.42	539.35	569.25	140
160	217.98	250.43	282.91	315.32	347.78	380.23	412.68	445.17	477.61	510.07	542.52	574.98	607.43	160
180	225.62	260.60	295.61	330.62	365.61	400.60	435.61	470.61	505.59	540.61	575.59			180
200	233.24	270.79	308.34	345.88	383.43	420.96	458.51	496.04	533.61	571.17				200
220	240.89	280.98	321.07	361.16	401.25	441.32	481.43	521.51	561.61					220
240	248.52	291.15	333.77	376.42	419.05	461.70	504.34	546.95						240
260	256.14	301.33	346.50	391.69	436.87	482.06	527.22							260
280	263.80	311.52	359.25	406.98	454.70	502.43								280
300	271.43	321.68	371.97	422.25	472.52	522.78								300'

Child safety device (10482) – add on £9.55.

All prices shown exclude VAT



# Venetian Blinds

## SG 8300 (25mm)

Mono control Venetian Blind System.  
 Slats 25mm.  
 Maximum System Width: 3m  
 Minimum System Width: 50cm  
 Maximum System Drop: 3m  
 Maximum Surface Area: 4.5m<sup>2</sup>

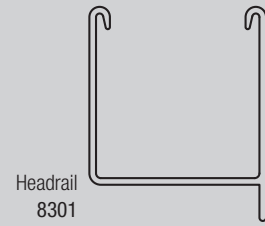
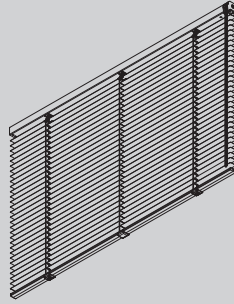

The prices in the tables below comprise the complete system made-to-measure with 25mm slats ready to hang. If sizes lie between the measurements shown, the price for the next size larger will apply. For side-guide or sloping add 20%.

### Price Group 1

Price Category C

Width Drop cm	60cm	80cm	100cm	120cm	140cm	160cm	180cm	200cm	220cm	240cm	260cm	280cm	300cm	Width Drop cm
60	151.32	167.08	182.84	198.63	214.36	230.13	245.91	261.68	277.46	293.22	309.00	324.78	340.53	60
80	155.34	172.44	189.56	206.69	223.79	240.91	258.03	275.13	292.24	309.34	326.46	343.58	360.72	80
100	159.37	177.82	196.27	214.76	233.21	251.63	270.11	288.58	307.02	325.48	343.95	362.40	380.85	100
120	163.42	183.22	203.01	222.81	242.60	262.40	282.22	302.02	321.82	341.62	361.40	381.23	401.01	120
140	167.45	188.57	209.72	230.88	252.01	273.17	294.32	315.46	336.60	357.74	378.89	400.03	421.19	140
160	171.45	193.95	216.45	238.94	261.43	283.92	306.40	328.89	351.39	373.86	396.34	418.87	441.33	160
180	175.49	199.35	223.17	247.02	270.85	294.64	318.51	342.32	366.17	390.00	413.83			180
200	179.54	204.70	229.90	255.06	280.24	305.43	330.60	355.79	380.96	406.14				200
220	183.57	210.08	236.62	263.13	289.65	316.18	342.68	369.22	395.76					220
240	187.59	215.49	243.33	271.19	299.07	326.91	354.77	382.67						240
260	191.63	220.82	250.04	279.26	308.45	337.66	366.91							260
280	195.68	226.21	256.79	287.31	317.89	348.43								280
300	199.69	231.60	263.49	295.39	327.29	359.19								300

### Price Group 2

Price Category C

Width Drop cm	60cm	80cm	100cm	120cm	140cm	160cm	180cm	200cm	220cm	240cm	260cm	280cm	300cm	Width Drop cm
60	155.72	172.96	190.21	207.44	224.69	241.92	259.17	276.41	293.64	310.88	328.14	345.37	362.61	60
80	161.23	180.30	199.39	218.45	237.53	256.59	275.68	294.77	313.83	332.91	351.97	371.03	390.12	80
100	166.73	187.62	208.54	229.45	250.37	271.26	292.20	313.08	334.00	354.91	375.83	396.74	417.64	100
120	172.22	194.98	217.73	240.48	263.22	285.95	308.70	331.43	354.20	376.93	399.66	422.41	445.17	120
140	177.75	202.33	226.89	251.47	276.04	300.65	325.19	349.79	374.36	398.95	423.53	448.10	472.66	140
160	183.24	209.65	236.06	262.50	288.88	315.30	341.72	368.14	394.54	420.96	447.35	473.79	500.20	160
180	188.75	216.98	245.24	273.49	301.74	329.99	358.23	386.49	414.71	442.96	471.23			180
200	194.23	224.33	254.40	284.49	314.57	344.63	374.74	404.84	434.92	464.99				200
220	199.76	231.67	263.60	295.49	327.42	359.34	391.25	423.17	455.10					220
240	205.25	238.99	272.77	306.48	340.26	374.02	407.75	441.51						240
260	210.76	246.35	281.92	317.52	353.09	388.68	424.28							260
280	216.27	253.69	291.12	328.53	365.94	403.36								280
300	221.76	261.03	300.27	339.53	378.79	418.06								300

### Price Group 3

Price Category C

Width Drop cm	60cm	80cm	100cm	120cm	140cm	160cm	180cm	200cm	220cm	240cm	260cm	280cm	300cm	Width Drop ft.ins.
60	178.51	199.94	221.40	242.84	264.27	285.69	307.13	328.56	349.99	371.42	392.85	414.28	435.74	60
80	188.22	212.88	237.55	262.22	286.88	311.54	336.22	360.87	385.56	410.22	434.89	459.54	484.22	80
100	197.90	225.80	253.71	281.60	309.54	337.42	365.30	393.21	421.09	448.99	476.89	504.80	532.69	100
120	207.61	238.73	269.88	301.01	332.11	363.25	394.39	425.53	456.66	487.79	518.92	550.05	581.19	120
140	217.30	251.68	286.02	320.39	354.75	389.11	423.51	457.85	492.22	526.59	560.95	595.30	629.65	140
160	227.02	264.59	302.19	339.80	377.41	414.99	452.58	490.17	527.78	565.36	602.96	640.55	678.16	160
180	236.69	277.53	318.36	359.19	400.02	440.84	481.68	522.51	563.32	604.16	645.00			180
200	246.40	290.46	334.51	378.57	422.65	466.69	510.76	554.84	598.90	642.97				200
220	256.10	303.40	350.68	397.97	445.27	492.56	539.86	587.13	634.45					220
240	265.80	316.31	366.84	417.38	467.89	518.44	568.95	619.47						240
260	275.50	329.26	383.02	436.75	490.55	544.29	598.02							260
280	285.22	342.19	399.16	456.18	513.14	570.16								280
300	294.88	355.12	415.33	475.56	535.78	596.00								300

Child safety device (10482) – add on £9.55.

All prices shown exclude VAT



# Wooden Slat Venetian Blinds

## SG 8910

Mono control wooden slat Venetian Blind System.  
Bass wood slat 50mm.

## SG 8960

Electrically operated Venetian Blind System.  
Average operating speed 3cm/sec.

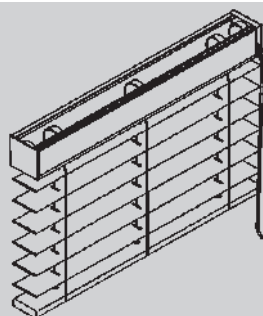

The prices in the table below comprise the complete system made-to-measure with 50mm slats ready to hang with universal bracket 8920. If sizes lie between the measurements shown, the price for the next size larger will apply. Headrail covered with actual slat to match. For F.R. treated wood please add £115.70/m<sup>2</sup> to prices below.

### SG 8910 – 50mm Slat size

Max. system width: 243cm      Min. system width: 65cm  
Max. system drop: 275cm      Max. surface area: 4.6m<sup>2</sup>      Price Category C

Width ▶ Drop ▼ cm	80cm	100cm	120cm	140cm	160cm	180cm	200cm	220cm	245cm	◀ Width ▼ Drop cm
80	280.15	345.50	366.79	454.43	473.22	547.02	598.09	621.48	674.71	80
90	286.80	353.14	375.36	466.16	486.03	560.84	615.05	639.59	693.96	90
100	293.45	360.75	383.90	477.87	498.78	574.67	631.99	657.69	713.19	100
110	303.42	372.19	396.77	495.37	517.90	595.40	657.43	684.77	741.96	110
120	321.06	419.33	419.33	507.06	530.71	609.21	674.39	702.87	761.20	120
130	338.71	413.42	441.91	518.75	543.47	623.03	691.35	720.96	780.42	130
140	353.61	430.48	461.06	542.21	569.01	650.68	725.21	757.11	818.83	140
150	359.20	436.86	468.27	550.97	578.60	661.06	737.96	770.68	833.25	150
160	364.76	443.23	475.45	559.73	588.16	671.48	750.67	784.24	847.67	160
170	379.67	460.29	494.54	583.12	613.64	699.11	767.61	820.37	886.10	170
180	395.37	478.50	514.67	607.07	639.50	727.53	784.59	838.47	905.28	180
190	411.05	496.70	534.83	630.99	665.32	755.93	818.47	856.58	924.49	190
200	422.89	510.29	550.10	649.68	685.65	777.96	843.91	883.72		200
210	430.83	519.34	560.27	662.11	699.22	792.65	860.88			210
220	438.77	528.37	570.43	674.56	712.78	807.30	877.83			220
230	454.54	546.43	590.77	699.36	739.92	836.71	911.70			230
240	460.50	553.23	598.40	708.72	750.09	846.60				240
250	466.46	560.03	606.01	718.05	760.25	858.75				250
260	482.25	578.11	626.36	742.93	787.38	888.15				260
275	500.21	593.70	641.92	758.50	801.23					275

### 50mm Slat (standard/premium colours)

Slat Description

**Standard Colours – Use above price chart**

Alabaster	Holstein	Pecan
Alpine	Light Oak	Sandwash
Cloud	Linen	Soft White
Cottage Pine	Natural	Stark
Eggshell	New Walnut	Sugar Maple
Golden Oak	New Wenge	Yarrin

Slat Description

**Premium Colours – Use above price chart plus 20%**

Acid	Envy	Hypnosis	Matumi	Zura
Astro	Exquis	Icon	Nata	
Caroba	Feline	Isiro	Orali	
Cassia	Fizz	Koli	Pardo	
Cirrus	Gravity	Koto	Poison	
Electric	Halti	Lulu	Vamp	

**Note:** Premium Colours are supplied with white headbox and accessories as standard. Silver, bronze and vanilla are also available on request.

Wooden slat Venetian blinds are made with natural wood. It is therefore an inherent feature of the product that variation in shade and graining as well as slight warping may occur.

For Premium colour/finishes as detailed above: an additional cost of 20% applies.

TAPED VENETIAN System 8910 is available with fabric tapes at an additional cost of 7-5%.

Please enquire at Silent Gliss for information about the colours available.

### SG 8960 – Electrically Operated Venetian Blind System (50mm wooden slat)

Max. system width: 243cm      Min. system width: 75cm  
Max. system drop: 275cm      Max. surface area: 4.6m<sup>2</sup>

Electrically operated with integral 230v motor no. 11095. Supplied with special recess switch 0613 as standard. For pricing, add to relevant price in table above the sum of **£785.94**

#### 8960 Control Options

Radio control standard option is with System 0450, see page 24.

Radio control option with integrated receiver available only with 9940 controls – add on £177.71, see page 28.

System 8960 is available with fabric tapes at an additional cost of 7-5%.

SIDE-GUIDES are available for both systems at an additional cost of **£26.97**

All prices shown  
exclude VAT



# Aluminium Slat Venetian Blind

## SG 8910

Mono control Venetian Blind System.  
Aluminium slat 50mm.

## SG 8960

Electrically operated Venetian Blind System.  
Average operating speed 3cm/sec.

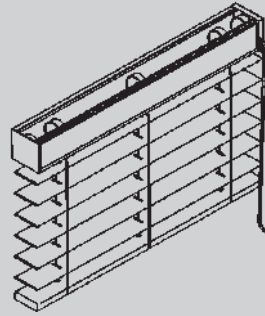

The prices in the table below comprise the complete system made-to-measure with 50mm slats ready to hang with universal bracket 8920. If sizes lie between the measurements shown, the price for the next size larger will apply. Headrail covered with actual slat to match. Plus coordinating or contrasting component options. Please refer to 8910 catalogue for recommended (standard) colour combinations. Multicoloured blinds please add 20% to prices below.

## SG 8910 – 50mm Slat size

Max. system width: 360cm  
Max. system drop: 360cm  
Min. system width: 65cm  
Max. surface area: 10m<sup>2</sup>

Price Category C

Width ► Drop ▼ cm	60cm	80cm	100cm	120cm	140cm	160cm	180cm	200cm	220cm	240cm	260cm	280cm	300cm	320cm	340cm	360cm	◀ Width ▼ Drop cm
60	115.34	145.71	176.11	206.42	236.83	267.14	297.59	327.99	358.34	388.68	418.99	449.43	479.79	510.15	540.54	570.89	60
70	118.56	148.97	179.26	209.66	240.06	270.42	300.77	331.12	361.50	391.95	422.29	452.65	483.01	513.32	543.76	574.09	70
80	121.82	152.21	182.51	212.90	243.23	273.65	304.04	334.36	364.70	395.10	425.46	455.89	486.24	516.55	546.90	577.36	80
90	125.00	155.37	185.76	216.12	246.50	276.84	307.26	337.57	367.95	398.32	428.72	459.07	489.41	519.81	550.13	580.54	90
100	128.22	158.58	188.96	219.36	249.69	280.07	310.47	340.83	371.15	401.59	431.90	462.29	492.65	523.01	553.39	583.75	100
110	131.42	161.78	192.20	222.53	252.93	283.27	313.65	344.06	374.37	404.81	435.13	465.48	495.80	526.23	556.63	587.01	110
120	134.62	165.06	195.37	225.75	256.17	286.49	316.89	347.24	377.61	407.79	438.36	468.73	499.07	529.42	559.82	590.18	120
130	137.87	168.28	198.61	228.96	259.31	289.69	320.08	350.48	380.84	411.20	441.56	471.92	502.34	532.72	563.05	593.37	130
140	141.09	171.47	201.87	232.17	262.58	292.92	323.29	353.64	384.07	414.40	444.75	475.21	505.52	535.90	566.29	596.63	140
150	144.29	174.69	205.06	235.41	265.79	296.17	326.54	356.92	387.25	417.60	447.92	478.39	508.73	539.10	569.50	599.81	150
160	147.53	177.88	208.28	238.63	269.01	299.36	329.76	360.12	390.45	420.86	451.18	481.61	511.95	542.31	572.72	603.02	160
170	150.74	181.16	211.42	241.83	272.26	302.59	333.00	363.33	393.64	424.04	454.44	484.84	515.18	545.49	575.88	606.26	170
180	153.96	184.38	214.65	245.02	275.39	305.82	336.19	366.56	396.90	427.27	457.63	488.01	518.38	548.73	579.10	609.50	180
190	157.21	187.53	217.94	248.31	278.66	308.97	339.40	369.75	400.11	430.52	460.87	491.27	521.61	551.95	582.31	612.65	190
200	160.39	190.76	221.14	251.47	281.88	312.19	342.57	372.95	403.32	433.75	464.08	494.45	524.81	555.20	585.62	615.95	200
210	163.59	193.95	224.36	254.72	285.10	315.49	345.77	376.13	406.54	436.91	467.33	497.69	527.99	558.36	588.78	619.17	210
220	166.79	197.21	227.53	257.94	288.30	318.64	349.08	379.44	409.80	440.12	470.49	500.88	531.26	561.60	592.01	622.32	220
230	170.02	200.41	230.77	261.15	291.51	321.85	352.26	382.65	413.03	443.36	473.73	504.06	534.44	564.82	595.22	625.57	230
240	173.28	203.66	234.02	264.36	294.71	325.08	355.45	385.88	416.21	446.59	476.92	507.31	537.68	568.01	598.45	628.75	240
250	176.46	206.85	231.59	267.55	297.91	328.31	358.67	389.07	419.43	449.82	480.13	510.53	540.86	571.27	601.66	631.99	250
260	179.71	210.06	240.42	270.80	301.16	331.54	361.93	392.27	422.61	453.01	483.37	513.78	544.16	574.47	604.83	635.21	260
270	182.91	213.29	243.63	273.99	304.35	334.76	365.16	395.48	425.82	456.21	486.57	517.00	547.33	577.72	608.08	638.45	270
280	186.10	216.52	246.84	277.21	307.59	337.92	368.39	398.72	429.07	459.42	489.79	520.19	550.55	580.91	611.25	641.68	280
290	189.33	219.70	250.07	280.44	310.85	341.16	371.57	401.93	432.26	462.68	493.02	523.35	553.76	584.09	614.53	644.86	290
300	192.51	222.94	253.29	283.61	314.06	344.40	374.77	405.15	435.47	465.89	496.31	526.64	556.97	587.32	617.71		300
310	195.75	226.17	256.49	286.86	317.26	347.60	377.97	408.33	438.72	469.07	499.50	529.87	560.19	590.55	620.93		310
320	198.95	229.37	259.72	290.10	320.51	350.81	381.17	411.58	441.93	472.31	502.65	533.06	563.44	593.81			320
330	202.20	232.53	262.95	293.33	323.66	354.04	384.41	414.71	445.16	475.55	505.87	536.27	566.61	597.02			330
340	205.41	235.79	266.13	296.53	326.87	357.28	387.65	418.03	448.36	478.73	509.10	539.46	569.83				340
350	208.65	238.99	269.38	299.75	330.12	360.47	390.85	421.25	451.58	481.98	512.32	542.73	573.03				350
360	211.85	242.29	272.60	302.94	333.32	363.69	394.09	424.42	454.81	485.15	515.56	545.91	576.27				360

## SG 8960 – Electrically Operated Venetian Blind System (50mm aluminium slat)

Max. system width: 360cm  
Max. system drop: 360cm  
Min. system width: 75cm  
Max. surface area: 10m<sup>2</sup>

Electrically operated integral 230v motor no. 11095. Supplied with special recess switch 0613 as standard. For pricing, add to relevant price in table above the sum of **£785.94**

### 8960 Control Options

Radio control standard option is with System 0450, see page 24.

Radio control option with integrated receiver available only with 9940 controls – add on £177.71, see page 28.

System 8960 is available with fabric tapes at additional cost of 7.5%.

SIDE-GUIDES are available for both systems at an additional cost of £26.97

All prices shown exclude VAT



# Leather Slat Venetian Blinds

## SG 8910

Mono control leather slat Venetian Blind System with low descent mechanism (50mm).

## SG 8960

Electrically operated Venetian Blind System. Average operating speed 3cm/sec.

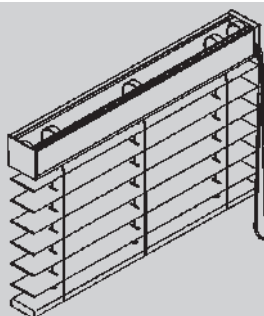

The prices in the table below comprise the complete system made-to-measure with 50mm slats ready to hang with universal bracket 8920. If sizes lie between the measurements shown, the price for the next size larger will apply. Headrail covered with actual slat to match. Plus coordinating or contrasting component options. Please refer to 8910 catalogue for recommended (standard) colour combinations.

Leather venetian slats are a natural product, therefore slight variations in colour and texture are an inherent feature. Headrails are sprayed to match system colour as standard.

## SG 8910 – 50mm Slat size

Max. system width: 243cm  
 Max. system drop: 275cm  
 Min. system width: 65cm  
 Max. surface area: 4.6m<sup>2</sup>

Price Category C

Width ▶ Drop ▼ cm	80cm	100cm	120cm	140cm	160cm	180cm	200cm	220cm	245cm	◀ Width ▼ Drop cm
80	559.86	667.51	789.08	896.67	1016.42	1123.55	1231.15	1341.52	1448.65	80
90	610.76	731.09	865.87	986.18	1118.11	1238.40	1358.75	1481.31	1601.65	90
100	662.15	794.67	942.17	1075.17	1220.27	1353.30	1485.84	1621.61	1754.62	100
110	713.03	858.74	1018.92	1164.66	1322.47	1467.70	1613.40	1761.88	1907.62	110
120	763.91	922.32	1095.21	1253.65	1424.15	1582.56	1741.01	1903.57	2061.97	120
130	815.31	986.42	1172.01	1343.11	1526.36	1697.46	1869.96	2043.87	2214.97	130
140	866.20	1050.00	1248.29	1432.09	1628.05	1813.71	1997.56	2184.14	2367.98	140
150	917.07	1113.58	1325.09	1521.59	1730.21	1928.11	2124.65	2324.45	2520.95	150
160	968.44	1177.68	1401.33	1610.59	1833.80	2043.01	2252.21	2464.71	2673.95	160
170	1019.31	1241.27	1478.13	1700.08	1935.49	2157.91	2379.82	2604.49	2826.92	170
180	1070.20	1305.33	1554.42	1790.94	2037.65	2272.29	2507.42	2766.12	3001.24	180
190	1121.60	1368.91	1631.22	1879.92	2139.85	2387.15	2634.98	2906.38		190
200	1172.48	1432.49	1708.89	1969.42	2241.53	2502.05	2783.39	3046.68		200
210	1223.37	1496.58	1785.65	2058.40	2343.70	2616.96	2910.99	3186.98		210
220	1274.72	1560.18	1861.94	2147.86	2445.89	2752.62	3038.54			220
230	1325.61	1625.63	1938.74	2236.85	2547.58	2867.53	3166.15			230
240	1376.49	1689.21	2015.03	2326.36	2671.10	2982.43				240
250	1427.37	1752.79	2091.30	2415.34	2772.78	3096.81				250
260	1478.77	1816.88	2168.06	2504.80	2874.94					260
275	1531.04	1880.48	2244.35	2615.61	2977.15					275

## SG 8960 – Electrically Operated Venetian Blind System (50mm leather slat)

Max. system width: 243cm  
 Max. system drop: 275cm  
 Min. system width: 75cm  
 Max. surface area: 4.6m<sup>2</sup>

Electrically operated with integral 230v motor no. 11095. Supplied with special recess switch 0613 as standard. For pricing, add to relevant price in table above the sum of **£785.94**

### 8960 Control Options

Radio control standard option is with System 0450, see page 24.

Radio control option with integrated receiver available only with 9940 controls – add on £177.71, see page 28.

**SIDE-GUIDES** are available for both systems at an additional cost of **£26.97**

Leather covered headrail available for both systems at an additional cost of **£511.01** per blind

All prices shown exclude VAT





# Plissée Pleated Blinds

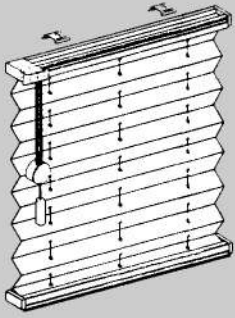

## SG 8500

Plissée Pleated Blind System supplied complete ready made.  
White aluminium head and bottom rail. Pleats 20mm.

Plissée Pleated Blind Systems are supplied made-to-measure, ready to install. White aluminium headrail and components are supplied as standard, silver grey, anthracite and brown are also available. For special colours see page 69.

Please use our technical information leaflet to determine the required Plissée model and contact Silent Gliss for a price.

Choose from following model types:

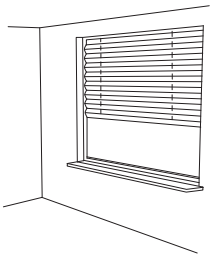

### Model Type 'A' – Vertical Freehanging

Electric Operation: AE10

Chain Operation: AK10

Pull Cord Operation: A010, A013, A020, A030, A040, A070

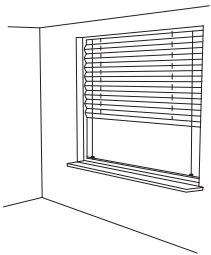

### Model Type 'B' – Vertical Side-Guide

Electrical Operation: BE10

Handle Operation: BB10, BB10U, BB20, BB20U, BB24, BB30, BB80, BB81, BB85

Chain Operation: BK10

Pull Chord Operation: B010, B020, B060, B061, B075

Fixed: BF50, BF51, BF52, BF55, BF56

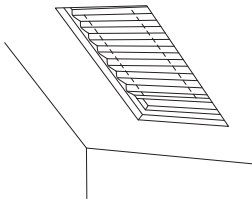

### Model Type 'D' – Inclined

Handle Operation: DB10, DB10U, DB20, DB30

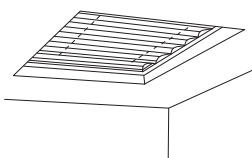

### Model Type 'P' – Horizontal

Handle Operation: PB10, PB15, PB30, PB35, PB40, PB41, PB45, PB46, PB60, PB61, PB65, PB66, PB70, PB71, PB75, PB76, PB80, PB81, PB85, PB86

Electrical Operation: PE10, PE15, PE60, PE61, PE65, PE66, PE70, PE71, PE75, PE76

Crank Operation: PR10, PR15, PR60, PR61, PR65, PR66, PR70, PR71, PR75, PR76

PRICING: Price on application – please contact Silent Gliss

All prices shown exclude VAT

## Logo and Digital Printing

We are able to print logos and images on a wide variety of fabrics, including Screens, Visiotex, Element, Mercurio B and Colorama. It is important to note that the denser the fabric, the better the quality of the image transfer.

Suitable artwork must be provided with a reasonable size and high d.p.i. (dots per inch). Prices on application.

For more information please see Digital Printing brochure.

## Special Colours – Profile and Components

Standard stock colours are indicated and priced accordingly on the relevant system page.

In addition, any UK powder manufacturer's standard/stock RAL or BS colour may also be matched by spraying (delivery 4 weeks).

For Dim-Out blinds, please refer to pricing on page 53. For all other systems, the following charges apply:

	Price Ctg.
<b>Set-up charge (1 per colour)</b>	<b>E</b>
Standard/Classic Range stock RAL or BS colours:	£238.50
Standard Silent Gliss colours (excluding chrome):	£113.50
Non-standard RAL or BS colours:	POA
<b>Plus add the following prices to the relevant assembled system price (use silver finish):</b>	
£6.72 per metre of profile	
£8.95 per set of endcovers/wall supports/endpieces/cord guides	
For tracks with sprayable brackets please use bracket spraying cost below.	
Note:	
Profile should not be bent once sprayed.	
Maximum sprayed profile length is 6 metres.	
Nylon components sprayed to colour match may sustain damage in the future.	
<b>Metropole Coloured Extension Brackets</b>	<b>E</b>
Set up charge:	£113.50 (Chrome only)
Spray charge:	£7.36 per bracket and bracket cover
Drilling charge:	£3.69 per bracket
Lead time approx. 6 weeks.	



# Made-to-measure Curtains

# Wave®

## CURTAIN HEADING SYSTEM

Curtain prices need to be added to the hardware prices.

Prices are for unlined curtains.

For standard lining add 10% or for blackout lining add 15%.

Price Category A

### Price Group 1 Fabrics

Colorama 1  
Someo  
Sunset

Width ► Drop ▼	150cm	200cm	250cm	300cm	350cm	400cm	450cm	500cm	◀ Width ▼ Drop
Up to 300cm	361.50	482.00	602.50	723.00	843.50	964.00	1084.50	1204.99	Up to 300cm
301-350cm	541.65	723.00	904.34	1085.69	1267.03	1448.38	1629.72	1811.07	301-350cm
351-400cm	622.78	831.57	1040.35	1249.14	1457.92	1666.72	1875.50	2084.29	351-400cm

### Price Group 2 Fabrics

Breeze  
Colorama 1 Alu  
Colorama 2  
Colorama 2 Bioactive  
Freshtex Light  
Freshtex Linlook  
Freshtex Ultralight

Freshtex Vision  
Leviso  
Natural  
Reflex  
Silente 20  
Somnia  
Twist

Width ► Drop ▼	150cm	200cm	250cm	300cm	350cm	400cm	450cm	500cm	◀ Width ▼ Drop
Up to 300cm	496.31	660.96	825.60	990.24	1154.89	1319.53	1484.17	1648.81	Up to 300cm
301-350cm	744.47	991.44	1238.40	1485.37	1732.33	1979.30	2226.26	2473.23	301-350cm
351-400cm	856.62	1140.57	1424.52	1708.47	1992.42	2276.37	2560.31	2844.26	351-400cm

### Price Group 3 Fabrics

Deep  
Freshtex Dimout  
Linea  
Newlife 1/2  
Silente 10

Width ► Drop ▼	150cm	200cm	250cm	300cm	350cm	400cm	450cm	500cm	◀ Width ▼ Drop
Up to 300cm	968.77	1290.89	1613.02	1935.15	2257.28	2579.40	2901.53	3223.66	Up to 300cm
301-350cm	1453.15	1936.35	2419.53	2902.73	3385.91	3869.11	4352.30	4835.49	301-350cm
351-400cm	1670.29	2226.26	2782.22	3338.19	3894.16	4450.13	5006.09	5562.06	351-400cm

### Fabric Joining Information

By reducing the number of joins the overall curtain appearance improves. The table below indicates the maximum drop available **without joins** for each fabric.

Max drop 260cm	Max drop 280cm	Max drop 290cm	Max drop 300cm
Colorama 1 Alu	Leviso Somnia	Deep Freshtex Dimout Freshtex Light Freshtex Ultralight Freshtex Vision	Linea Newlife 1/2 Silente 10 Silente 20
			Breeze Colorama 1 Colorama 2
			Colorama 2 Bioactive Twist

All prices shown exclude VAT

# Made-to-measure Curtains

## Snake Wave®

Supplied ready assembled complete with curtain.  
 Prices are for unlined curtains.  
 1060 available in anodised or white powder coated finish.  
 6465 available in anodised or white powder coated finish.  
 Top fix only.  
 Standard hem is with overlapped stitching.  
 Single stack only.

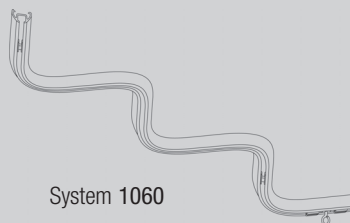

System 1060

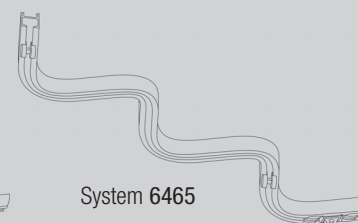

System 6465

### SG 1060

Hardware including fabric up to 3 meter drop.

Price Category C

Width ►	71cm	111cm	151cm	191cm	231cm	271cm	311cm	351cm	391cm	431cm	471cm
Price Group 1	470.52	540.00	611.43	682.86	962.59	1034.03	1105.46	1149.72	1198.51	1242.78	1486.27
Price group 2	592.79	662.26	733.69	805.12	1207.11	1278.54	1349.97	1398.77	1443.03	1487.30	1853.06
Price group 3	764.86	838.85	910.28	977.19	1555.78	1627.21	1694.11	1742.91	1791.70	1835.96	2373.81
Price group 4	909.76	979.22	1050.65	1122.09	1841.06	1912.49	1983.92	2032.72	2076.97	2121.24	2803.98

Optional Deep Hem	18.12	27.17	36.23	45.28	54.33	63.40	72.45	104.15	135.85	172.07	217.35
-------------------	-------	-------	-------	-------	-------	-------	-------	--------	--------	--------	--------

### SG 6465

Hardware including fabric up to 3 meter drop.

Price Category C

Width ►	86cm	134cm	182cm	230cm	278cm	326cm	374cm	422cm	470cm
Price group 1	478.60	551.62	629.13	914.93	987.90	1060.89	1138.44	1188.77	1442.89
Price group 2	605.39	673.89	751.40	1159.45	1232.44	1309.93	1382.96	1433.30	1809.66
Price group 3	777.45	850.48	923.46	1508.13	1581.10	1654.08	1731.64	1781.96	2330.41
Price group 4	922.37	990.86	1068.36	1793.39	1866.38	1943.89	2016.92	2067.24	2760.59

Optional Deep Hem	22.64	36.23	45.28	54.33	67.92	76.98	86.03	122.26	163.01
-------------------	-------	-------	-------	-------	-------	-------	-------	--------	--------

Price Group 1	Price Group 2	Price Group 3	Price Group 4
Breeze Colorama 1 Someo	Colorama 1 Alu Colorama 2 Colorama 2 Bioactive Freshtex Light Freshtex Linlook Freshtex UltraLight Freshtex Vision Natural Sunset Twist	Leviso Newlife 1 Reflex Silente 20 Somnia	Deep Freshtex Dimout Linea Newlife 2 Silente 10

All prices shown exclude VAT

# Price Index for Rails & Parts

All prices shown  
exclude V.A.T.

Product	Description	Unit Prices				Per Metre Price				Ctgy
		Each	Per 10	Per 100	Other Qty	Price	1m	100m	Other Lgth	
18R	Round Head Screw No.8, 25mm/1"			15.49						A
28C	Counter Sunk Screw No.8, 50mm/2"			19.23						A
28R	Round Head Screw No.8, 50mm/2"			29.23						A
148C	Counter Sunk Screw No.8, 19mm/3/4"			16.16						A
0222	(New Code 6794) Screw for 5600 Direct Fix	0.05		4.54						C
0240	Screw for 6243 Profile	0.34		32.85						A
0273	(New Code 20273) Connecting Bridge for 6140, Antique Bronze, Anodic Grey, Black, Ecu, Silver, Slate Grey, Taupe, White, Matt White	27.25								A
0286	Cable Clips	0.12								A
0270	RACUB Module	401.14								C
0304	(New Code 20304) 36mm Wood/Matched Fused Barrel finial pair (all colours except chrome matched)	97.75	899.31							A
0308	(New Code 20308) 23mm Wood/Matched Fused Barrel finial pair (all colours except chrome matched)	89.46	778.32							A
0311	(New Code 20311) 30mm Wood/Matched Fused Barrel finial pair (all colours except chrome)	105.93	921.52							A
0315	(New Code 20315) 50mm Wood/Matched Fused Barrel finial pair	172.74	1502.77							A
0318	(New Code 20318) 36mm Wood/Matched Fused Ball finial pair (all colours except chrome matched)	104.56	961.95							A
0321	(New Code 20321) 23mm Wood/Matched Fused Ball finial pair (all colours except chrome matched) Pair	95.66	832.19							A
0323	0.5m Blue patch cable	1.85								C
0324	(New Code 20324) 30mm Wood/Matched Fused Ball finial pair (all colours except chrome) Pair	112.92	982.48							A
0327	(New Code 20327) 50mm Wood/Matched Fused Ball finial pair	171.59	1492.85							A
0329	(New Code 20329) 23mm Glass Ball finial clear or frosted (all pole colours)	50.52	439.49							A
0331	(New Code 20331) 30mm Glass Ball finial clear or frosted	53.61	466.43							A
0333	(New Code 20333) 50mm Glass Ball finial clear or frosted	101.60	883.94							A
0334	(New Code 20334) Maxi Adjustable Bracket, Silver, Black, Gunmetal, White, Matt White, Charcoal, Ecu, Bronze, Antique Bronze, Anodic Grey, Slate Grey, Ochre, Sand, Taupe	34.30	294.02							A
0335	(New Code 20335) Top Fix Bracket, Silver, Black, Gunmetal, White, Matt White, Charcoal, Ecu, Bronze, Antique Bronze, Anodic Grey, Slate Grey, Ochre, Sand, Taupe	17.35	148.75							A
0335	(New Code 20335) Top Fix Bracket, chrome	32.28	280.71							A
0336	Eight channel hand held remote	180.00								C
0339	(New Code 20339) 23mm Flush Endcap, Silver, Charcoal, Ecu, White, Matt White Gunmetal, Chrome	9.43	92.10							A
0340	(New Code 20340) 30mm Cording Set without endcap, Black, Gunmetal, White, Matt White, Charcoal, Ecu, Bronze, Antique Bronze, Anodic Grey, Slate Grey, Ochre, Sand, Taupe and Chrome	46.79	438.55							A
0346	(New Code 20346) 30mm Flush Endcap, Silver, Black, Gunmetal, White, Matt White, Charcoal, Ecu, Bronze, Antique Bronze, Anodic Grey, Slate Grey, Ochre, Sand, Taupe, Chrome	8.04	76.29							A
0347	(New Code 20347) 50mm Cording Set without endcap, Black, White, Matt White, Ecu, Antique Bronze, Anodic Grey, Slate Grey, Taupe	55.72	529.37							A
0350	(New Code 20350) 50mm Flush Endcap, Silver, White, Matt White, Ecu, Black	25.05	245.50							A
0350	(New Code 20350) 50mm Flush Endcap, Antique Bronze, Anodic Grey, Slate Grey, Taupe	25.67	251.51							A
0351	(New Code 20351) 36mm Flush Endcap, Silver, Black, White, Matt White, Gunmetal, Chrome, Antique bronze, Slate Grey, Charcoal, Anodic Grey	8.16	80.01							A
0516	(New Code 3151) Clearance spacer (for top boards)			64.89						A
0551	Diagonal fixing support complete including track and wall fixings	82.14			metre drop	12.97				A
0552	Transfer unit for loading device	245.99								A
0553	Connecting bridge for loading device	53.97								A
0554	Loading device access	114.95								A
0556	(New Code 20556) Ball end, Silver, Black, Gunmetal, White, Matt White, Charcoal, Ecu, Bronze, Antique Bronze, Anodic Grey, Slate Grey, Ochre, Sand, Taupe, Chrome 30mm poles	40.50	385.74							A
0562	(New Code 5339) Lead with in-line connector	102.34								C
0565	Non latching recess switch, white, 1 gang	102.18								C
0566	Non latching recess switch, white, 2 gang	176.89								C
0567	Non latching recess switch, white, 3 gang	275.45								C
0568	Non latching recess switch, white, 4 gang	350.17								C
0569	Non latching recess switch, white, 6 gang	528.65								C
0570	(New Code 9953) Volt free switching module	192.97								C
0593	Gland set for 5682	3.55								C
0595	Swivel plate	135.31								C
0614ST	Wireless switch, white	115.91								C
0615	Mains Switch, white, 1 gang, including back box	55.19								C
0616	Latching recess switch, white, 2 gang	74.38								C
0617	Latching recess switch, white, 3 gang	120.87								C
0618	Latching recess switch, white, 4 gang	145.36								C
0619	Latching recess switch, white, 6 gang	201.44								C
0628	(New Code 20628) Groove cylinder finial for 1003	19.14								A
0629	(New Code 20629) Groove cylinder finial for 6130	23.24								A



# Price Index for Rails & Parts

All prices shown  
exclude V.A.T.

Product	Description	Unit Prices				Per Metre Price				Ctgy
		Each	Per 10	Per 100	Other Qty	Price	1m	100m	Other Lgth	
0630	(New Code 20630) Groove cylinder finial for 6140	53.76								A
0646	(New Code 20646) 50mm intermediate pulley set (for 6160), White, Black, Ecu, Matt White	65.40								A
0646	(New Code 20646) 50mm intermediate pulley set (for 6160), Taupe, Antique Bronze, Anodic Grey, Slate Grey	72.42								A
0652	(New Code) 10139) Screw	0.08								A
0661	Side guide wire						0.89			A
0674	(New Code 20674) Pillar bracket, Silver, Black, White, Matt White, Ecu,	10.69								A
0674	(New Code 20674) Pillar bracket, Gunmetal, Charcoal, Bronze, Antique Bronze, Anodic Grey, Slate Grey, Ochre, Sand, Taupe	11.22								A
0674	(New Code 20674) Pillar bracket, chrome	27.56								A
0686	(New Code 2671) Bottom weight 89mm/3 1/3" without horns			103.72						C
0687	(New Code 2672) Bottom weight 127mm/5" without horns			80.92						C
0690	Cord Connector White	2.37	22.60							A
0697	(New Code 20697) 50mm Strata hand clear/ribbed disc, Antique Bronze, Anodic Grey, Black, Ecu, Silver, Slate Grey, Taupe, White, Matt White	71.44	664.44							A
0697	(New Code 20697) 50mm Strata hand coloured disc, Antique Bronze, Anodic Grey, Black, Ecu, Silver, Slate Grey, Taupe, White, Matt White	82.63	768.46							A
0700	(New Code 20700) Profile for 6140 Black, Ecu, Silver, White, Matt White						44.84			A
0700	(New Code 20700) Profile for 6140 Antique Bronze, Anodic Grey, Slate Grey, Taupe,						60.77			A
0701	(New Code 20701) 50mm corded profile, Black, Ecu, Silver, White, Matt White						70.87			A
0701	(New Code 20701) 50mm corded profile, Antique Bronze, Anodic Grey, Slate Grey, Taupe,						82.15			A
0706	(New Code 20706) Stud endcap for 1003, Ecu, Gunmetal, Charcoal, Silver, White, Matt White, Chrome	9.43	92.11	856.78						A
0707	(New Code 20707) Stud endcap for 6130, Antique Bronze, Anodic Grey, Black, Bronze, Charcoal, Ecu, Gunmetal, Slate Grey, Silver, Sand, Ochre, Taupe, White, Matt White, Chrome	8.04	76.29	724.77						A
0710	(New Code 20710) Stud endcap for 6101, Antique Bronze, Anodic Grey, Black, Gunmetal, Charcoal, Silver, Slate Grey, White, Matt White, Chrome, (includes grub screw)	8.15	77.55	734.61						A
0714	(New Code 20714) Stud endcap for 6140 50mm, Black, Ecu, Silver, White, Matt White	25.05								A
0714	(New Code 20714) Stud endcap for 6140 50mm, Antique Bronze, Anodic Grey, Slate Grey, Taupe	25.66								A
0715	(New Code 6669) Dustcap for 6650 (2.5mtr length)							1m	5.83	A
0717	(New Code 20717) Ballend finial 50mm Antique Bronze, Anodic Grey, Black, Ecu, Silver, Slate Grey, Taupe, White, Matt White	80.07								A
0718	(New Code 20718) Spear finial 50mm Antique Bronze, Anodic Grey, Black, Ecu, Silver, Slate Grey, Taupe, White, Matt White	80.07								A
0719	(New Code 20719) Spear finial 30mm Antique Bronze, Anodic Grey, Black, Bronze, Charcoal, Ecu, Gunmetal, Slate Grey, Sand, Ochre, Taupe, White, Matt White	39.50								A
0724	Connecting Bridge with Cover for 6130 All colours	15.43								A
0766	(New Code 9916) In line connector for electric Roller blinds	64.33								C
0785	(New Code 6679) Acrylic disc for use with 6655	7.54								A
0798	(New Code 20798) M4 x 10 countersunk screw (for 6151/6141)			24.32						A
0839	Knot Holder	0.47								A
0873	(New code 20873) Design end cap for 6130, Antique Bronze, Anodic Grey, Black, Bronze, Charcoal, Ecu, Gunmetal, Slate Grey, Silver, Sand, Ochre, Taupe, White, Matt White	17.77								A
0877	(New Code 3164) Hook & Latch Set	1.48		143.95						A
0878	(New Code 3165) Breakway Ring Set Softfold	0.95		92.95						A
0879	(New Code 3166) Breakway Ring Set Softfold (per metre)						8.88			A
0884	(New Code 20884) Crystal Cube 23mm	49.68								A
0886	(New Code 20886) Crystal Cube 30mm	65.45								A
0894	(New Code 20894) Crystal cylinder 23mm, base in White, Silver, Ecu, Matt White	56.73	527.60							A
0894	(New Code 20894) Crystal cylinder 23mm, base in Chrome, Gunmetal, Charcoal	60.82	565.61							A
0896	(New Code 20896) Crystal cylinder 30mm, base in Silver, Black, Ecu, White, Matt White,	69.07	642.39							A
0896	(New Code 20896) Crystal cylinder 30mm, base in Antique Bronze, Anodic Grey, Bronze, Charcoal, Gunmetal, Slate Grey, Sand, Ochre, Taupe, Chrome	73.98	688.01							A
0898	(New Code 20898) Crystal square 50mm base	84.75								A
0899	(New Code 20899) Crystal cylinder 50mm base	88.62								A
0901	(New Code 20901) 30mm Strata Hand clear/ribbed disc - standard colours	36.94								A
0901	(New Code 20901) 30mm Strata Hand coloured disc - standard colours	49.92								A
0907	Control module (low voltage motor Type A)	317.90								C
0913	Single-channel wall switch, brushed silver, mirror finish	230.62								C
0913	Single-channel wall switch, brass	264.42								C
0914	Eight-channel wall switch, brushed silver, mirror finish	230.62								C
0914	Eight-channel wall switch, brass	264.42								C
0917	White pattress box	20.59								C

# Price Index for Rails & Parts

All prices shown  
exclude V.A.T.

Product	Description	Unit Prices					Per Metre Price				Ctgy
		Each	Per 10	Per 100	Other Qty	Price	1m	100m	Other Lgth	Price	
0918	Control Module (Motor Type A)	294.47									C
0919	Control Module (Motor Type B)	294.47									C
0921	Booster for 0450 system	473.89									C
0922	Power supply for 0921 booster	118.47									C
0937	Programmable switch for 8250	139.91									C
0938	Black box for 0937	7.47									C
0985	(New Code 20985) Groove Ball finial for 1003	42.45									A
0986	(New Code 20986) Groove Ball finial for 6130/6120	48.22									A
0989	(New Code 20989) Blok Bracket, Antique Bronze, Anodic Grey, Black, Bronze, Charcoal, Ecu, Gunmetal, Slate Grey, Silver, Sand, Ochre, Taupe, White, Matt White (for poles)	32.58									A
0989	(New Code 20989) Blok bracket in chrome	48.87									A
0991 CL	(New Code 20991) Shard Flat clear finial for 6100	36.15									A
0991 ET	(New Code 20991) Shard Flat etched finial for 6100	44.50									A
0993 CL	(New Code 20993) Shard Cylinder clear finial for 1003	39.34									A
0993 ET	(New Code 20993) Shard Cylinder etched finial for 1003	48.37									A
0995 CL	(New Code 20995) Shard Cylinder clear finial for 6130	46.17									A
0995 ET	(New Code 20995) Shard Cylinder etched finial for 6130	56.73									A
1003	Rail, silver, white, matt white, Ecu in 6 metre lengths only						20.14				A
1003	Rail, gunmetal, bronze, Charcoal, in 6 metre lengths only Chrome (4 metre lengths only)						27.54				A
1021	Rail, silver in 5 metre or 6 metre lengths only						6.46				A
1021	Rail, silver, cut to size						7.07				A
1021	Rail, white, in 6 metre lengths only						13.90				A
1021	Rail, white, cut to size						14.50				A
1025	Rail, silver in 5 metre or 6 metre lengths only						6.46				A
1025	Rail, silver, cut to size						7.07				A
1025	Rail, white, in 6 metre lengths only						13.90				A
1025	Rail, white, cut to size						14.50				A
1071	Rail, white in 6 metre lengths only						8.10				A
1071	Rail, white cut to size						8.91				A
1072	Endcap for 1070 Hand, white.		4.81	45.84							A
1080	Rail, silver in 5 metre or 6 metre lengths only						8.61				A
1080	Rail, silver, cut to size						9.42				A
1080	Rail, white in 5 metre or 6 metre lengths only						9.08				A
1080	Rail, white, cut to size						10.11				A
1080	Rail, matt white, anodic grey, antique bronze, charcoal in 6m lengths only						18.60				A
1080	Rail, matt white, anodic grey, antique bronze, charcoal cut to size						19.46				A
1082	Rail, white, in 5 metre or 6 metre lengths only (System 3000)						16.75				A
1082	Rail, white, cut to size (System 3000)						17.31				A
1090	Rail, silver in 5 metre or 6 metre lengths only						7.38				A
1090	Rail, silver, cut to size						8.02				A
1090	Rail, white in 5 metre or 6 metre lengths only						7.64				A
1090	Rail, white, cut to size						8.42				A
1105	Spacer	0.77	7.30	69.14							A
11210C	Counter sunk screw No.10, 37mm/1 1/2"			21.73							A
1128C	Counter sunk screw No.8, 37mm/1 1/2"			24.86							A
1128R	Round head screw No.8, 37 mm/1 1/2"			24.86							A
1148C	Counter sunk screw No.8, 31mm/1 1/4"			18.80							A
1148R	Round head screw No.8, 31mm/1 1/4"			22.29							A
1280	Rail, white, in 5/6 m lengths, outers of 10 lengths only						12.28				A
1348R	Round head screw No.8, 44mm/1 3/4"			27.39							A
2004	Bottom weight bar (4 metre length max) 40mm						20.00				A
2006	Aluminium weight bar (4 metre length max) 28mm						14.28				A
2048	Bead chain							278.25			A
2049	Gear Drive	27.49	261.72	2378.44							A
2059	Safety Clip		9.85								A
2075	Rod cover with ring	1.42	13.55	128.92							A
2081	Take up reel, 2120 system	12.26	109.96								A
2091	Endcover (for 2135 steel rod)	1.14	10.53	100.28							A
2093	Ring		2.60	24.58							A
2094	Small cord guide/endstop	1.01	9.21								A
2101	Cord guide		24.71	226.08							A
2101	Cord guide, Euroslot sachet of 2	5.83									A
2103T	Transparent loop tape							159.38			A
2104	Cleat, white nylon	3.40	30.90								A
2111	Hexagonal bar								6m	92.48	A
2111	Hexagonal bar, outer of 50 lengths								6m	69.34	A
2116	Velcro profile								5m	96.32	A
2116	Velcro profile, outer of 40 lengths								5m	86.68	A
2131	Short end-cover	1.85	16.55								A

# Price Index for Rails & Parts

All prices shown  
exclude V.A.T.

Product	Description	Unit Prices				Per Metre Price				Ctgy	
		Each	Per 10	Per 100	Other Qty	Price	1m	100m	Other Lgth		Price
2135	Steel rod							3m	8.51	A	
2136	Tubular tape (for 2135 steel rod)							185.62		A	
2136CR	Tubular tape, cream							190.61		A	
2138	(Old Code 3066A) T <sup>h</sup> bracket A, silver, white with 1 rivetted clamp	41.65								C	
2139	(Old Code 3066B) T <sup>h</sup> bracket A, silver, white with 2 rivetted clamps	42.00								C	
2143	Cord connector	1.82	16.34							A	
2144	Cross rail							4m	54.67	C	
2145	Glider, wide channel for side rails	1.36	13.06							C	
2151	Rail, silver in 6 metre lengths only						107.22			C	
2151	Rail, silver, cut to size						117.98			C	
2156	Drive shaft						13.86	6m	75.58	C	
2160	Motor	1107.05								C	
2163	Flat drawing tape 6mm							220.64		A	
2164	Ring tape							200m	608.42	A	
2164T	Transparent ring tape							50m	152.11	A	
2179	Endcover for 2211	1.57	14.78							A	
2182	Sleeve and pin, pair				2.00	13.90				C	
2187	Connector	44.71								C	
2188	Glider Insert for 2144	1.26	12.03							C	
2189	Gear, system 2190	180.57								C	
2191	Rail, silver, 6 metre lengths only						22.64			C	
2191	Rail, silver, cut to size						24.90			C	
2191	Rail, white, 6 metre lengths only						24.06			C	
2191	Rail, white, cut to size						26.46			C	
2191	Rail, bronze, and black in 6 metre lengths only						35.55			C	
2191	Rail, bronze, and black cut to size						39.07			C	
2192	Belt drive endpiece set	12.86								C	
2192W	Belt drive endpiece set, white	13.46								C	
2193	Belt return set	12.86								C	
2193W	Belt return set, white	13.14								C	
2196	Lead weight tape							50m	148.74	A	
2197	Wooden acorn	2.53								A	
2198	Pencil pleat tape							50m	298.84	A	
2199	Oval wooden weight section							3m	16.26	A	
2211	Velcro Profile						35.42	6m	193.09	A	
2216	Cord							1000m	274.97	A	
2221	Velcro tape							100m	549.96	A	
2230	Set, white, grey	27.00								C	
2242	Connector	34.45								C	
2248	Cross rod							6m	88.44	C	
2255	Adjustable brake	7.40	70.45							A	
2301	Profile White							5.8m	64.38	A	
2302	Clip bracket	1.15								A	
2306	Gear/Breakaway set (1:1)	14.35								A	
2307	Gear/Breakaway set (4:1)	15.45								A	
2308	Spool with lift cord, 2304/2305 systems	5.45								A	
2309	Hexagonal Bar							5m	9.00	A	
2310	Plastic bead chain							250m	135.00	A	
2311	Metal bead chain							150m	322.50	A	
2312	Bead chain joiner	0.50								A	
2316	Gear without breakaway mechanism (1:1)	9.90								A	
2317	Gear without breakaway mechanism (4:1)	10.20								A	
2319	Plastic chain joiner	0.10								A	
2346	Clamp bracket	1.62								A	
2347/50	50cm drop plastic chain loop	1.25								A	
2347/75	75cm drop plastic chain loop	1.40								A	
2347/100	100cm drop plastic chain loop	1.60								A	
2347/125	125cm drop plastic chain loop	1.85								A	
2347/150	150cm drop plastic chain loop	2.05								A	
2347/175	175cm drop plastic chain loop	2.25								A	
2347/200	200cm drop plastic chain loop	2.60								A	
2363	Wall/ceiling bracket for 2350	4.11								A	
2471	Bottom weight 5"/127mm	1.08		103.72						C	
2473	Bottom weight 3½"/89mm	0.86		80.92						C	
2479	Link chain 5"/127mm						1.01	500m	451.97	C	
2481	Link chain 3½"/89mm						1.01	500m	451.97	C	
2521	Face Fix Bracket (49.6mm)	1.77								C	
2539	Touch and close pile section							184.51	25m	51.26	A
2573	Master Carrier for Electric Panel System	12.90								C	
2601	Profile only,white						25.69			C	

# Price Index for Rails & Parts

All prices shown  
exclude V.A.T.

Product	Description	Unit Prices					Per Metre Price				Ctgy
		Each	Per 10	Per 100	Other Qty	Price	1m	100m	Other Lgth	Price	
2601	Profile only, silver						25.07				C
2604	Guide	5.62									
2605	Top clip 127mm each, white	0.42		36.60							C
2606	Reducing Top clip 127mm for 2810	0.80		75.37							C
2608	Endstop for 2601	13.26									C
2610	Endstop	2.04									C
2611	Stopper	1.84									C
2612	Brake	3.36									C
2613	Connector	15.13									C
2614	Recess Profile (suspended ceilings)						24.87				C
2615	Recess profile						19.67				C
2616	Bracket, white	4.16									C
2616	Bracket, silver	2.28									C
2618	Shaft	1.00									C
2620	Pilot Runner	7.01									C
2623	Rotation element (123mm)	2.47									C
2624	Rotation element (101mm)	2.47									C
2625	Rotation element (89mm)	2.47									C
2671	(Old Code 0686) Bottom weight 89mm/3 1/3" without horns			103.72							C
2672	(Old Code 0687) Bottom weight 127mm/5" without horns			80.92							C
2759	Crossrail, 0.13mm								4m	34.65	C
2813	Top clip 89mm, white	0.42		36.60							C
2821	Spacer (65mm)	0.81									C
2826	Chain connector	1.29	12.38								A
2849	PVC top clip			47.11							C
2865	Twin connector	1.70									C
2872	Operating chain, white						3.13		250m reel	775.40	C
3003	Clamp		44.43	399.85							C
3004	Clamp		13.93	125.49							A
3008	Connecting bridge	11.29									A
3016	Endstop	0.49		36.77							A
3016	Endstop, Euroslot sachet of 2	1.91									A
3017	Endstop	0.97		87.99							A
3020	Hook			43.73							A
3030	Pilot runner	2.03		177.61							A
3032	Spring stop		8.09	72.69							A
3033	Clamp for 2900	2.64	23.77								C
3036	(Old Code 3065) L' bracket A, silver, white with 1 rivetted clamp	8.75									C
3041	Clamp	7.11	71.05								A
3045	Metal overlap	4.18	37.62								A
3060	Clamp for 6465, 1070, 6465	0.61	6.08	60.76							A
3062	Connecting bridge for 1020 / 6465	2.70									A
3065	(New Code 3036) L' bracket A, silver, white with 1 rivetted clamp	8.75									C
3066A	(New Code 2138) T' bracket A, silver, white with 1 rivetted clamp	41.65									C
3066B	(New Code 2139) T' bracket A, silver, white with 2 rivetted clamps	42.00									C
3067	Connecting bridge for 6243 profile	3.93									A
3068A	Loop tape								250mtr Reel	624.07	A
3069	Child Safety Eyelet	0.66		64.60							A
3070	Twist eye endstop	0.73	6.53	58.35							A
3071	Screw twist endstop	0.94	9.00								A
3073	Bottom tape adjuster	0.38	2.87								A
3089	(Old Code 3533/6146) Glider with hook				20.00	10.42					A
3090	Cord							137.60			A
3090A	Cord								500m	652.33	A
3091	Cord, black							192.93			A
3096	Connecting bridge 1090	6.24	56.18								A
3113	5cm spacer 1090		20.78	186.97							A
3151	(Old Code 0516) Clearance spacer (for top boards)			64.89							A
3164	(Old Code 0877) Hook & Latch Set	1.48		143.95							A
3165	(Old Code 0878) Breakway Ring Set Sofffold	0.95		92.95							A
3166	(Old Code 0879) Breakway Ring Set Sofffold (per metre)						8.88				A
3175	Universal nylon bracket for 1090/1200 system	1.33	12.28	73.41							A
3176	Top fix bracket 1090/1200, white	1.33	12.28	73.41							A
3208A	Intermediate pulley, 3000, grey and white	37.50	341.41								A
3208A	Intermediate pulley, 3000, Antique Bronze, black, gold	42.55	395.27								A
3213	Adjustable carrier 3000	2.84		251.42							A
3231	Endfix bracket 3000	9.85	93.47								A
3242	Nylon overlap	3.06	27.04	216.65							A
3242	Nylon overlap, Euroslot sachet of 1	3.92									A
3288	Endpiece set 3000, white	31.49			25.00	702.09					A

# Price Index for Rails & Parts

All prices shown  
exclude V.A.T.

Product	Description	Unit Prices					Per Metre Price				Ctgy
		Each	Per 10	Per 100	Other Qty	Price	1m	100m	Other Lgth	Price	
3289	Endpiece set, grey	32.61									A
3289	Endpiece set, white	34.70									A
3511	Glider			11.97	25000.00	2400.65					A
3532	Glider			25.36	5000.00	1016.35					A
3533	Glider			13.41	25000.00	2682.16					A
3533	Glider, sachets of 25 x 25	82.86									A
3533	Glider, Euroslot sachets of 25	4.39									A
3533/6146	(New Code 3089) Glider with hook				20.00	10.42					A
3534	Glider in strip form				1000.00	114.73					A
3548	Retrofit glider				25.00	6.19					A
3548	Retrofit glider			22.60	1000.00	225.54					A
3562	Standard tape							232.51			A
3570	Rotating glider		2.94	25.77							A
3571	Hook			11.81	35000.00	3469.63					A
3571	Hook, sachet of 25 x 25	78.87									A
3571	Hook, Euroslot sachet of 25	4.00									A
3579	Glider/hook	0.24	2.23	21.44							A
3579	Glider/hook, Euroslot sachet of 25	6.54									A
3580	Glider/hook			47.64	5000.00	2272.61					A
3582	Plastic hook			10.49							A
3582	Plastic hook, sachets of 25 x 25	88.09			625.00	88.08					A
3582	Plastic hook, outer 20000				20000.00	1863.06					A
3582	Plastic hook, outer 1000				1000.00	98.06					A
3582	Plastic hook, Euroslot sachets of 25				25.00	3.69					A
3599	2 prong hook			16.45	25000.00	3132.88					A
3599	2 prong hook, sachets of 25 x 25	125.70									A
3599	2 prong hook, Euroslot sachets of 25	5.41									A
3600	Picture hanging set	22.19									A
3602	Wall support 1080, grey	4.80	45.44								A
3602	Wall support 1080, white	5.03	45.63								A
3603	Top fix bracket, white	1.78	16.20	147.54							A
3603	Top fix bracket, Euroslot sachets of 2, white	4.63									A
3604	Nylon Corner Piece (White Only)	3.44									A
3605	Endcover 1080, white	2.48	22.57	214.98							A
3606	Snap fastener 1080	1.26	9.85								A
3611	Ceiling stud 1085	2.20									A
3612	Sleeve for 3610	4.86									A
3615	Clamp/insert for pelmet system	1.08									A
3618	Metal wall support	6.98	62.85								A
3620	Connecting bridge	13.20	123.71								A
3626	Return fixing bracket	4.20	37.78								A
3630	White universal nylon bracket	1.71	13.60	123.74							A
3630	Universal nylon bracket, white, black Euroslot sachet of 2	4.46									A
3630	Universal nylon bracket, black, gold, brown	1.91	17.17								A
3634	Height adjuster	3.85									A
3637	Cord							69.93			A
3637A	Cord								500m	314.78	A
3638	Re-inforced corner piece, grey, white	2.89	26.34	239.99							A
3639	Hanger rod assembly complete	22.29									A
3639	Hanger rod assembly complete, per extra foot	2.60									A
3648	Eyelet for 3638	0.48	4.14	37.20							A
3655	Long universal bracket	2.91	27.67	251.77							A
3657	Connecting bridge 3600	4.38									A
3660	Extra long universal bracket	3.62									A
3660	Extra long universal bracket, Euroslot sachet of 1	4.73									A
3663	Profile hook	3.34									A
3666	Cord Tidy	1.18	10.71	97.33							A
3667	Endcover/stop, white, grey	1.35	13.02	124.18							A
3667	Endcover/stop, white, grey, Euroslot sachets of 2	3.78									A
3667	Endcover/stop, matt white, anodic grey, antique bronze, charcoal	2.78	26.46	252.00							A
3802	Connecting bridge	14.56									A
3825	Clamp		20.68	197.92							A
3826	Top fix bracket	1.36	12.41	111.71							A
3832	Twist clamp	2.61									A
3833A	Intermediate pulley (White)	53.60									A
3833A	Intermediate pulley - Matt white, grey, anodic grey, antique bronze, charcoal	58.62									A
3836	Face fix bracket, White	2.82									A
3841	Rail, silver, white in 6 metre lengths only						18.39				A
3841	Rail, silver, white, cut to size						20.43				A
3841	Rail, matt white, anodic grey, antique bronze, charcoal in 6 metre lengths only						32.68				A



# Price Index for Rails & Parts

All prices shown  
exclude V.A.T.

Product	Description	Unit Prices					Per Metre Price				Ctgy
		Each	Per 10	Per 100	Other Qty	Price	1m	100m	Other Lgth	Price	
3841	Rail, matt white, anodic grey, antique bronze, charcoal, cut to size						34.51				A
3842	Endcap for 3840 Hand, white, grey	0.50	4.50	40.00							A
3842	Endcap for 3840 Hand, matt white, anodic grey, antique bronze, charcoal	4.30	40.98	390.00							A
3845	Endpiece set, white/grey	17.87									A
3845	Endpiece set, matt white, anodic grey, antique bronze, charcoal	24.09									A
3846	Endpiece set, white, grey	24.71									A
3914	Bracket for return profile	14.77									A
3915	Endpiece set				20.00	404.47					A
3915	Endpiece set				50.00	910.45					A
3916	Pilot runner for multi-stack system	1.71	15.25								A
3917	Pilot runner	2.34		222.81							A
3922	Roller gliders in strip form, outer of 1000				1000.00	462.58					A
3922	Roller gliders in strip form, outer of 8000				8000.00	3196.14					A
3929A	Intermediate pulley	58.02	552.39								A
3932	Spring stop	0.84	7.95								A
3933	Click glider in strip form, outer of 1000				1000.00	293.90					A
3935	Overlap arm (System 3900)	21.84	208.11								A
3935A	Combination overlap with 'S' hook attachment 3949	24.60	234.30								A
3936	Overlap arm (System 3900)				20.00	220.34					A
3936A	Combination overlap with 'S' hook attachment 3949	14.78	140.75								A
3939	Pilot runner	1.99		190.97							A
3942	Intermediate stop	3.34	32.45								A
3947	Pair of magnetic gliders		94.63								A
3971	Rail, white in 6 metre lengths only						22.50				C
3971	Rail white cut to size						24.75				C
3975	Overlap for pulling by hand (1280)	20.03	190.72								A
3982	Rail, white, available in 5 metre or 6 metre lengths in outers of 10 lengths only (System 3900)						19.23				A
3985	Endcover in white 1280			213.27							A
4221	Bottom weight bar, white, silver or black						19.16				C
4223	Plastic strip with adhesive 12mm						3.38				C
4226	Standard adhesive tape, 30mm								54m	298.68	C
4845	Metal bead chain (2020/2120)								125m	493.35	A
4845BR	Metal bead chain, brass (2020/2120)								125m	927.90	A
5118	Wedge	5.29									C
5130	Drive belt for 2190/2195						12.29				C
5190	Motor 100-250V AC with 5 Metre lead	250.46									A
5301	Rail, silver in 6 metre lengths only						49.25				C
5301	Rail, white in 6 metre lengths only						51.87				C
5302	Drive belt						19.79				C
5304	Drive set, white, grey	109.97									C
5310	Endset, return, white, grey	95.10									C
5312	Endstop	12.97									C
5317	Master carrier set	45.91									C
5318	Motor support	15.36									C
5319	Connecting bridge	34.45									C
5320	Clamp	4.73									C
5321	Master pilot	51.65									C
5339	(Old Code 0562) Lead with in-line connector	102.34									C
5360	Motor	2637.50									C
5670	Overlap	64.03									C
5682	Hood	15.13									C
5684	Connector	32.44									C
5736	Surface relay socket	148.74									C
5778	Special plug for cable 5779, pair	3.56			2.00	7.12					C
5779	4 core low voltage connecting cable						4.87				C
5782ST	Single Channel radio handset white	103.57									C
5784ST	Multi channel radio handset white	136.50									C
5805	Motor for 5800	11009.85									C
5806	Pilot runner	31.46									C
5809	Roller glider		106.41								C
5810	Profile						111.16				C
5811	Overlap	215.95									C
5813	Floor frame	1354.30									C
5814	Cable						33.67				C
5815	Cord guide return	318.18									C
5816	Cord guide	416.23									C
5824	Endstop	34.22									C
5829	2 hole fixing plate	9.84									C
5834	Double pilot	230.69									C

# Price Index for Rails & Parts

All prices shown  
exclude V.A.T.

Product	Description	Unit Prices					Per Metre Price				Ctgy
		Each	Per 10	Per 100	Other Qty	Price	1m	100m	Other Lgth	Price	
6007	Endstop, silver	0.69	6.59								A
6007	Endstop, white	0.89	8.41								A
6010	Rail, white in 6 metre lengths only						17.13				A
6010	Rail, white cut to size						18.84				A
6018	Endcap, white for 6010		6.03	57.40							A
6021	Rail, white, in 5/6 metre lengths, others of 10 lengths only						11.64				A
6024	Panel glide connecting bridge	12.56									C
6053	Spring stop	1.36	12.62								A
6063	Overlap	10.81	98.33	919.04							A
6063R	Overlap arm with rollers for 6120	18.70									A
6064	Screw twist endstop	1.32	11.16								A
6065	Twist eye endstop	1.15	10.59	97.40							A
6070	Cord 6200/6370							385.80			C
6079	Overlap	35.19									C
6086	Spring stop	1.92	18.06	164.07							A
6094	Roller glider with hook		31.66	301.20							A
6098	Roller glider with eye		26.70	253.30							A
6099	(Old Code 6098W) Wave roller glider (80mm)								50m	2770.41	A
6101	Rail, white in 4.5m, 5m, 5.5m, 6m, 6.75m lengths only						32.06				A
6101	Rail, silver in 4.5m, 5m, 5.5m, 6m, 6.75m lengths only						28.51				A
6101	Rail, black, 6m lengths only						28.23				A
6101	Rail, Gunmetal, Antique Bronze, Anodic Grey, Charcoal, Slate Grey, Matt White 6m lengths only, Rail, chrome, 4m lengths only						41.37				A
6103	Rail, Silver, White, Matt White Ecru Black in 6 metre lengths only						29.54				A
6103	Rail, Antique Bronze, Anodic Grey, Bronze, Charcoal, Gunmetal, Slate Grey, Sand, Ochre, Taupe, Chrome (Chrome 4m lengths max)						43.24				A
6106	Rail, White, Matt White Ecru Black in 6 metre lengths only						38.76				A
6106	Rail, Antique Bronze, Anodic Grey, Bronze, Charcoal, Gunmetal, Slate Grey, Sand, Ochre, Taupe, Chrome (Chrome 4m lengths max)						53.27				A
6110	Dustcover, white						3.17				A
6122	Endstop			281.18							A
6124	Twist fixing plate	5.01									A
6137	Ceiling fix plate, single, silver	6.96									A
6137	Ceiling fix plate, single, white	7.64									A
6138	Ceiling fix plate, double, silver	7.75									A
6138	Ceiling fix plate, double, white	8.51									A
6138P	(New Code 6151) Ceiling support 3mm, Antique Bronze, Anodic Grey, Black, Bronze, Charcoal, Ecru, Gunmetal, Slate Grey, Silver, Sand, Ochre, Taupe, White, Matt White, Chrome	8.65	77.86								A
6138P/2	(New Code 6152) Ceiling support 9mm, Antique Bronze, Anodic Grey, Black, Bronze, Charcoal, Ecru, Gunmetal, Slate Grey, Silver, Sand, Ochre, Taupe, White, Matt White, Chrome for 6120	17.27	155.73								A
6141	Insert		24.48	225.49							A
6143	Glider			17.97	1000.00	167.81					A
6146	Hook			18.97	12.00	2.81					A
6147	Glider hook				20.00	12.13					A
6147	Glider hook				500.00	242.73					A
6147	Glider hook				8000.00	3251.84					A
6148	Glider (yellow)				1000.00	269.93					A
6149	Lead glider (blue)			66.36							A
6151	(Old Code 6138P) Ceiling support 3mm, Antique Bronze, Anodic Grey, Black, Bronze, Charcoal, Ecru, Gunmetal, Slate Grey, Silver, Sand, Ochre, Taupe, White, Matt White, Chrome	8.65	77.86								A
6152	(Old Code 6138P/2) Ceiling support 9mm, Antique Bronze, Anodic Grey, Black, Bronze, Charcoal, Ecru, Gunmetal, Slate Grey, Silver, Sand, Ochre, Taupe, White, Matt White, Chrome for 6120	17.27	155.73								A
6160	Track insert	16.45									A
6165	Intermediate Pulley for 6120, Antique Bronze, Anodic Grey, Black, Bronze, Charcoal, Ecru, Gunmetal, Slate Grey, Sand, Ochre, Taupe, White, Matt White, Chrome	63.77	637.65								A
6175	Mini hanger, silver	23.80									A
6175	Mini hanger, white	26.32									A
6187	Dummy ceiling support sleeve, silver	8.65									A
6187	Dummy ceiling support sleeve, white	9.99									A
6188	Ceiling support, silver	14.53									A
6188	Ceiling support, white	16.05									A
6190	Hanger rod assembly, complete including 6192 ceiling support and 6191 rod 61 cm (2') silver	30.89									A
6190	Hanger rod assembly, complete including 6192 ceiling support and 6191 rod 61 cm (2') white	34.17									A
6190	Hanger rod assembly, complete including 6192 ceiling support and 6191 rod 91 cm (3') silver	35.52									A
6190	Hanger rod assembly, complete including 6192 ceiling support and 6191 rod 91 cm (3') white	38.33									A

# Price Index for Rails & Parts

All prices shown  
exclude V.A.T.

Product	Description	Unit Prices					Per Metre Price				Ctgy
		Each	Per 10	Per 100	Other Qty	Price	1m	100m	Other Lgth	Price	
6191	Hanger tube, silver						15.35				A
6191	Hanger tube, white						17.06				A
6192A	Ceiling support, 50mm complete with stud 6193 and 2 grub screws, silver	18.95									A
6192A	Ceiling support, 50mm complete with stud 6193 and 2 grub screws, white	20.78									A
6192B	Ceiling support, 100mm complete with stud 6193 and 2 grub screws, silver	27.40									A
6192B	Ceiling support, 100mm complete with stud 6193 and 2 grub screws, white	30.05									A
6193	Stud for ceiling support	2.82									A
6194	Insert	2.61									A
6197	Hanger joint sleeve, silver	17.48									A
6197	Hanger joint sleeve, white	19.23									A
6199	Internal connecting bridge	11.97									A
6203	Connecting bridge	26.79									C
6209	Clamp	7.96	75.58								C
6214	Adjustable pilot	11.29									C
6224	Nylon clamp	13.74									C
6227	Master runner	11.29									C
6228	Double fixing plate	6.22									C
6243	Rail White in 6 metre lengths only						11.60				A
6268	Hanger for recess profile 2748 or profile 2948	10.78									C
6269	Connecting bridge for 6293	40.38									A
6283	Roller glider		16.57	157.22							A
6288	Plastic overlap arm	3.43	30.96	278.49							A
6290	Rail, White, in 5/6m lengths, outers of 10 lengths only						7.09				A
6293	Rail, white in 6 metre lengths only						29.84				A
6293	Rail, white cut to size						32.82				A
6349	Wave curtain tape, 50m, 100m rolls only							277.22	50.00	141.98	A
6354	Pilot runner for set 6119 (System 6120)	5.94	56.48								A
6363	Wave Iron-on hemming tape							197.37			A
6364	Extension arm	4.82	43.40								A
6365	Hanger	4.02	36.18								A
6366	Draw rod carrier	7.61	68.53								A
6367	Master carrier	2.41	21.71								A
6368	Carrier	2.41	21.71								A
6369	Insert for face fixing 6370	4.87									C
6371	Rail, silver in 4 metre, 5 metre and 6 metre lengths only						31.10				C
6371	Rail, silver, cut to size						35.94				C
6376	Connecting bridge	16.19	153.82								C
6377	Endpiece set, grey	38.92	370.66								C
6380	Rail, white in 6 metre lengths only						17.95				A
6380	Rail, white cut to size						19.75				A
6381	End cap white for 6380			280.86							A
6398	Clip	0.94	8.50								C
6501	V-hanger, silver	72.31			metre drop	26.88					A
6501	V-hanger, white	79.56			metre drop	29.55					A
6466	Rail, white in 6 metre lengths only						18.25				A
6466	Rail, white cut to size						20.08				A
6471	Endcover White		11.43	108.90							A
6503	Wall bracket complete, white, 25mm long with 50mm projection	15.02									A
6503	Wall bracket complete, silver, 25mm long with 50mm projection	13.63									A
6503	Wall bracket complete, white, 50mm long with 50mm projection	20.00									A
6503	Wall bracket complete, silver, 50mm long with 50mm projection	17.66									A
6503	Wall bracket complete, white, 100mm long with 50mm projection	24.79									A
6503	Wall bracket complete, silver, 100mm long with 50mm projection	22.07									A
6503	Wall bracket complete, white, 200mm long with 50mm projection	34.69									A
6503	Wall bracket complete, silver, 200mm long with 50mm projection	31.28									A
6503	Wall bracket complete, white, 50mm long with 100mm projection	29.51									A
6503	Wall bracket complete, silver, 50mm long with 100mm projection	26.28									A
6503	Wall bracket complete, white, 100mm long with 100mm projection	40.88									A
6503	Wall bracket complete, silver, 100mm long with 100mm projection	37.17									A
6503	Wall bracket complete, white, 75mm long with 150mm projection	71.63									A
6503	Wall brackets complete, silver 75mm long with 150mm projection	65.11									A
6511W	White cover for 6527	16.92									A
6512	Connecting bridge, silver	23.92									A
6512	Connecting bridge, white	27.23									A
6514M	T-junction, single, silver	11.05									A
6514M	T-junction, single, white	13.11									A
6519	Silver V-hanger rod						10.87				A

# Price Index for Rails & Parts

All prices shown  
exclude V.A.T.

Product	Description	Unit Prices				Per Metre Price				Ctgy
		Each	Per 10	Per 100	Other Qty	Price	1m	100m	Other Lgth	
6521	External bridge 6103, silver	69.45								A
6521	External bridge 6103, white	74.02								A
6524A	Diagonal fixing support, silver	44.31								A
6524A	Diagonal fixing support, white	53.22								A
6525A	Double T-junction, silver	15.21								A
6525A	Double T-junction, white	17.59								A
6609	Wall support, white	7.89								A
6609	Wall support, grey,	7.89								A
6611	Endcover, grey	6.11								A
6611	Endcover, white	6.89								A
6620	Wall bracket 6103, grey	14.19	128.33							A
6620	Wall bracket 6103, white	14.19	128.33							A
6625A	Fixing sleeve complete for V-hanger/diagonal support, silver	29.38								A
6625A	Fixing sleeve complete for V-hanger/diagonal support, white	33.16								A
6628	V-hanger track insert	22.27								A
6632	Internal connecting bridge 6103	9.36								A
6635	Internal connecting bridge	19.40								A
6639	Track insert	2.77								A
6655	Wall Support	32.11								A
6663	Wall brackets connector plate complete	38.83								A
6666	Safety connecting bridge	49.54								A
6669	(Old Code 0715) Dustcap for 6650 (2.5mtr length)							1m	5.83	A
6671	Washer insert for countersunk screw	1.94								A
6672	Cover for 6671	2.44								A
6675	Safety Device	40.56								A
6677	V-Hanger safety device	62.19								A
6679	(Old Code 0785) Acrylic disc for use with 6655	7.54								A
6739	Machine screw M4 6mm/ 1/4"			15.91						A
6748	Machine screw M4 8mm/ 5/16"			22.17						A
6770	Locking pin	1.57								A
6771	Vine eye	1.82								A
6784	Machine screw for 6639			16.51						A
6789	Grub screw	0.27								A
6794	(Old Code 0222) Screw for 5600 Direct Fix	0.05		4.54						C
6798	Machine screw M4 12mm/ 1/2"			23.26						A
6821	Rail, white in 6 metre lengths only					17.70				A
6821	Rail, white cut to size					19.47				A
6822	Rail, white in 6 metre lengths only					9.90				A
6822	Rail, white cut to size					10.89				A
6823	Endcover with screw white for 6820	6.13	58.38	556.00						A
6824	Endcover with screw white for 1020	5.81	55.37	527.34						A
6835A	Round head No. 4 screw 12mm/ 1/2"			8.90						A
6835B	Round head No. 4 screw 25mm/ 1"			15.36						A
6952	Magnetic handle holder	12.07								C
7002	Rail protector	5.78								A
8003	Bottom bar (16mm)					40.66		5m		C
8004	Bottom bar (25mm)					42.05		5m		C
8013	Bottom bar clip (25mm)	1.40	12.72							C
8235	Wire base short	2.20								C
8236	Wire base long	2.29								C
8237	Wire holder	2.20								C
8249A	Locking ring	0.64								C
8920	Universal bracket for 8910	7.28								C
9060	Motor, white, grey	907.37								C
9060	Motor, white, grey, slow motor	907.37								C
9063	Radio module set, white, grey (compatible with 0450)	169.84								C
9063EL	Radio module set, white, grey (compatible with 9940)	169.84								C
9068	Single channel receiver	392.30								C
9090	Motor for 2650/2950	716.91								C
9091	Motor with receiver for 2650/2950	814.97								C
9916	(Old Code 0766) In line connector for electric Roller blinds	64.33								C
9944	Single channel receiver, non latching	300.81								C
9945	Single channel receiver, latching	271.98								C
9946	Single channel wall switch	158.33								C
9947	Control unit DC 24V	177.75								C
9948	Single channel programmable wall switch with timer	395.85								C
9952	Hard wired timer switch	240.00								C
9953	(Old Code 0570) Volt free switching module	192.97								C
9960	Move server set (includes 1 x transmitter stick)	992.92								C

# Price Index for Rails & Parts

All prices shown  
exclude V.A.T.

Product	Description	Unit Prices					Per Metre Price				Ctgy
		Each	Per 10	Per 100	Other Qty	Price	1m	100m	Other Lgth	Price	
9961	Move transmitter stick	363.25									C
10040	Power supply set for 2650, 2950	125.06									C
10048	Power cable with plug for 5090, 2650 and 2950	7.31									C
10075	Lead weight						3.50				A
10076	Fabric weight white	8.62									A
10076/1	Fabric weight s/steel	8.21									A
10122	Profile cut to size, white, (for System 2700, 2 channel)						36.39				C
10123	Profile cut to size, white, (for System 2700, 3 channel)						58.71				C
10124	Profile cut to size, white, (for System 2700, 4 channel)						62.52				C
10125	Profile cut to size, white, (for System 2700, 5 channel)						67.91				C
10132	Profile cut to size, white (for System 2730, 2 channel)						28.69				C
10133	Profile cut to size, white (for System 2730, 3 channel)						45.05				C
10134	Profile cut to size, white (for System 2730, 4 channel)						61.39				C
10135	Profile cut to size, white (for System 2730, 5 channel)						77.74				C
10136	Top fix bracket for 2700, 2 channel profile only	3.55	33.77								C
10137	Top fix bracket for 2700, 3, 4 and 5 channel profiles	4.14	39.40								C
10139	(Old Code 0652) Screw	0.08									A
10140	Angle with screw	1.49									C
10142	Cover for 2 channel 2700 profile	2.19									C
10143	Cover for 3 channel 2700 profile	2.20									C
10144	Cover for 4 channel 2700 profile	2.25									C
10145	Cover for 5 channel 2700 profile	3.14									C
10146	Angle with screw	1.49									C
10148	Eyelet with screw	1.97									C
10150	Pilot runner with screw for 2700	3.91									C
10153	cord guide for 3 channel 2700 profile	7.94									C
10154	cord guide for 4 channel 2700 profile	8.01									C
10155	cord guide for 5 channel 2700 profile	9.43									C
10156	End stop with screw for 2700	3.10									C
10157	Wedge for 2700, 3870 and 6870 recess profiles	2.10	19.89								C
10172	Recess profile, 2 channel, (for System 2700)						31.94				C
10173	Recess profile, 3 channel, (for System 2700)						31.94				C
10174	Recess profile, 4 channel, (for System 2700)						31.94				C
10175	Recess profile, 5 channel, (for System 2700)						31.94				C
10177	Connecting bridge for 2730	5.70									C
10180	Carrier assembled, flexible, (for system 2730)						41.20				C
10200	Roller for 2700 carrier	1.39									C
10230	Carrier assembled, white, (for system 2700)						38.38				C
10234	Glass weight bar 16mm	1.58									C
10252	2700 carrier end cover left	0.78									C
10253	2700 carrier end cover right	0.78									C
10269	Face fix bracket, 60mm, white, (for System 2730)	4.43	42.24								C
10270	Face fix bracket, 80mm, white, (for System 2730)	4.99	47.41								C
10271	Face fix bracket, 100mm, white, (for System 2730)	5.54	52.59								C
10272	Face fix bracket, 60mm, white, (for System 2730)	6.08	57.77								C
10281	Slot nut (for System 2730)		16.35								C
10297	Solar Sensor	371.87									C
10298	Sensor	336.04									C
10300	Single channel hand held remote	221.14									C
10302	5 + 1 channel hand held remote	221.14									C
10303	10 + 2 + 1 channel hand held remote	269.53									C
10399	Design Fascia for 2730, white				per system	3.95	24.15				C
10400	Cord retainer	0.41									E
10430	Draw rod 50cm aluminium	9.35									A
10430	Draw rod 50cm white	10.14									A
10431	Draw rod 75cm aluminium	10.88									A
10431	Draw rod 75cm white	12.14									A
10432	Draw rod 100cm aluminium	12.33									A
10432	Draw rod 100cm white	13.86									A
10433	Draw rod 125cm aluminium	13.43									A
10433	Draw rod 125cm white	15.21									A
10434	Draw rod 150cm aluminium	14.42									A
10434	Draw rod 150cm white	16.42									A
10530	Chain for 4910 roller blind								150m	367.93	A
10530BR	Brass chain for 4910 roller blind								125m	323.64	A
10534	Continuous headrail profile for 4900, 4910, 4960 silver, white (per m width)	19.14									A
10539	Optional click bracket for fixing continuous headrail 10534	4.55									C
10542	Drive side bracket for 4910 white	3.86									C
10543	Click side bracket for 4910 white	3.61									C

# Price Index for Rails & Parts

All prices shown  
exclude V.A.T.

Product	Description	Unit Prices				Per Metre Price				Ctgy	
		Each	Per 10	Per 100	Other Qty	Price	1m	100m	Other Lgth		Price
10545	Spring clutch set for 4910 system	64.40								C	
10546	Spring clutch set for 4910 system	64.40								C	
10547	Spring clutch set for 4910 system	71.99								C	
10548	Spring clutch set for 4910 system	71.99								C	
10549	Spring clutch set for 4910 system	87.50								C	
10551	Spring clutch set for 4910 system	64.40								C	
10552	Spring clutch set for 4910 system	64.40								C	
10553	Spring clutch set for 4910 system	71.99								C	
10554	Spring clutch set for 4910 system	71.99								C	
10555	Spring clutch set for 4910 system	87.50								C	
10574	Bracket cover for 4900, 4910, 4960 white	2.27								C	
10575	Bracket cover for 4910, 4960 white	2.28								C	
10632	Intermediate bracket cover for 4900, 4910, 4960 white	5.45								C	
10633	Rectangular bottom bar for 4900, 4910, 4960 silver, white (per m width)	12.08								C	
10634	Oval bottom bar for 4900, 4910, 4960 silver, white (per m width)	12.08								C	
10635	End cover for rectangular bottom bar 10633 silver, white	1.33								C	
10637	End cover for oval bottom bar 10634 silver, white	1.33								C	
10639	End cover for round bootom bar 4221 silver, white	1.01								C	
10645	Pull grip set	12.85								C	
10697	Spring clutch set for 4910 system	87.50								C	
10698	Spring clutch set for 4910 system	87.50								C	
10699	Spring clutch set for 4910 system	87.50								C	
10700	Spring clutch set for 4910 system	87.50								C	
10707	Cushion, white 4900/4910	1.58								C	
10804	15 + 5 + 1 channel hand held-remote.	269.53								C	
10815	Cover, white, grey	1.49								A	
10816	Motor cover, white, grey	1.14								C	
10817	Motor case holder, white, grey	7.89								C	
10819	Belt return set, white, grey	12.60								C	
10820	Overlap arm, straight	4.77								C	
10821	Overlap arm, bent	5.11								C	
10821L	Long overlap arm, bent	40.17								C	
10822	Master carrier set	5.45								C	
10823	Belt connector arm	1.75								A	
10824	Belt connector pin	1.75								A	
10825	Drive belt						6.74	538.59		A	
10826	Overlap support set	6.02								C	
10831	Connecting bridge 5600	13.23								C	
10836	Mask pair stack	1.69								A	
10837	Pilot runner arm	2.27								C	
10838	Pilot runner set	25.66								C	
10840	Roller Glider	2.84	27.82	260.05						C	
10844	Wave endstop (motor), white, grey	1.59								C	
10845	Wave master carrier, single stack (80mm)	14.19								C	
10850	Rail, silver or white, 6 metre lengths only						16.58			C	
10850	Rail, silver or white, cut to size						18.23			C	
10852	Wave roller glider cord (80mm), 6.5mm channel								57m	3019.55	C
10854	Wave overlap support arm	2.32								A	
10856	Wave end stop (return end), white, grey	2.56								C	
10862	Recess profile for 5600, white, 6 metre lengths only						18.34			C	
10862	Recess profile for 5600, white, cut to size						20.16			C	
10863	Recess mask, motor, white	4.37								C	
10864	Recess mask, belt return, white	3.80								C	
10865	Mounting support plate	1.87								C	
10867	M4 X 16 Pan Head Screw for 5100	0.08								A	
10869	Wave roller glider cord (60mm), 6.5mm channel								43m	2885.84	C
10886	Wave overlap arm, pilot runner set	7.15								C	
10887	Wave overlap arm set	7.32								C	
10905	Wave glider cord (80mm), 6.5mm channel								50m	1482.74	A
10906	Wave glider cord (60mm), 6.5mm channel								50m	1778.99	A
10923	Pan head screw M4 x 12 for 3970			45.00						C	
10924	Wave glider support	1.84								A	
10925	Rail, white 6 metre lengths only (System 5100)								6m	86.52	A
10925	Rail, white, cut to size (System 5100)						15.14			A	
10926	Clamp	3.90	37.17	354.00						A	
10927	Hook for 5100	2.16								A	
10931	Roller Glider for 10925	0.40								A	
10933	Belt return & Motor Holder Set	7.48								A	
10936	Overlap Arm Set	11.52								A	
10940	Belt Return for 5100	6.28								A	



# Price Index for Rails & Parts

All prices shown  
exclude V.A.T.

Product	Description	Unit Prices					Per Metre Price				Ctgy
		Each	Per 10	Per 100	Other Qty	Price	1m	100m	Other Lgth	Price	
10942	Power supply 24V DC	51.15									C
10943	Connecting bridge for 5100	14.91									A
10945	Endstop for 5100	1.62									A
10946	1 Channel Transmitter White	50.67									A
10947	2+1 Channel Transmitter White	62.18									A
10948	6+1 Channel Transmitter White	62.18									A
10949	1 Channel Wall Transmitter White	42.03									A
10950	2+1 Channel Wall Transmitter White	62.18									A
10951	5+1 Channel Wall Transmitter White	62.18									A
11092	Timer White	122.64									A
11116	Smart Fix Bracket Cover with Magnet in Silver and White	4.39	41.85	398.61							A
11116	Smart Fix Bracket Cover with Magnet in Antique Bronze, Anodic Grey, Black, Bronze, Charcoal, Ecu, Gunmetal, Slate Grey, Sand, Ochre, Taupe, Matt White	5.18	49.32	469.68							A
11116	Smart Fix Bracket Cover with Magnet in Chrome	10.15	96.69	920.82							A
11118	Smart Fix 60mm Bracket in White and Silver (Set equivalent 11200)	3.71	34.13	324.31							A
11119	Smart Fix 80mm Bracket in White and Silver (Set equivalent 11201)	4.25	41.50	394.19							A
11120	Smart Fix 100mm Bracket in White and Silver (Set equivalent 11202)	4.37	42.03	399.34							A
11121	Smart Fix 120mm Bracket in White and Silver (Set equivalent 11203)	7.18	68.28	649.93							A
11122	Smart Fix 150mm Bracket in White and Silver (Set equivalent 11204)	7.34	69.78	664.35							A
11123	Smart Fix 200mm Bracket in White and Silver (Set equivalent 11205)	8.14	77.29	735.94							A
11124	Smart Fix 60mm Bracket Slotted for Metropole in Silver, Black, White, Matt White, Ecu, Gunmetal, Charcoal, Bronze, Antique Bronze, Anodic Grey, Slate Grey, Ochre, Sand, Taupe (Set equivalent 11206)	4.83	44.81	411.75							A
11124	Smart Fix 60mm Bracket Slotted for Metropole in Chrome (Set equivalent 11206)	8.18	79.83	742.55							A
11125	Smart Fix 80mm Bracket Slotted for Metropole in Silver, Black, White, Matt White, Ecu, Gunmetal, Charcoal, Bronze, Antique Bronze, Anodic Grey, Slate Grey, Ochre, Sand, Taupe (Set equivalent 11207)	5.75	53.27	489.53							A
11125	Smart Fix 80mm Bracket Slotted for Metropole in Chrome (Set equivalent 11207)	8.68	84.83	788.96							A
11126	Smart Fix 100mm Bracket Slotted for Metropole in Silver, Black, White, Matt White, Ecu, Gunmetal, Charcoal, Bronze, Antique Bronze, Anodic Grey, Slate Grey, Ochre, Sand, Taupe (Set equivalent 11208)	6.78	62.68	576.12							A
11126	Smart Fix 100mm Bracket Slotted for Metropole in Chrome (Set equivalent 11208)	11.02	107.66	1001.37							A
11127	M4 x 10 CSK. Head Screw for 6138P/6141			24.32							A
11128	Smart Fix Adjustable Extension Bracket slotted for Metropole in Silver, Black, White, Matt White, Ecu, Gunmetal, Charcoal, Bronze, Antique Bronze, Anodic Grey, Slate Grey, Ochre, Sand, Taupe (Set equivalent 11209)	8.49	80.90	770.44							A
11128	Smart Fix Adjustable Extension Bracket slotted for Metropole in Chrome (Set equivalent 11209)	17.66	168.17	1601.65							A
11137	Square Smart Fix Bracket Cover with Magnet in Silver and White	5.13	48.88	465.56							A
11137	Square Smart Fix Bracket Cover with Magnet in Antique Bronze, Anodic Grey, Black, Bronze, Charcoal, Ecu, Gunmetal, Slate Grey, Sand, Ochre, Taupe, Matt White	6.52	62.08	591.22							A
11137	Square Smart Fix Bracket Cover with Magnet in Chrome	10.29	97.98	933.18							A
11139	Square Smart Fix 60mm Bracket in White and Silver (Set equivalent 11210)	5.21	49.64	472.77							A
11140	Square Smart Fix 80mm Bracket in White and Silver (Set equivalent 11211)	5.75	54.72	521.18							A
11141	Square Smart Fix 100mm Bracket in White and Silver (Set equivalent 11212)	6.29	59.92	570.62							A
11142	Square Smart Fix 120mm Bracket in White and Silver (Set equivalent 11213)	6.94	66.08	629.33							A
11143	Square Smart Fix 150mm Bracket in White and Silver (Set equivalent 11214)	7.81	74.41	708.64							A
11144	Square Smart Fix 200mm Bracket in White and Silver (Set equivalent 11215)	8.89	84.68	806.49							A
11145	Square Smart Fix 60mm Bracket Slotted for Metropole in Silver, Black, White, Matt White, Ecu, Gunmetal, Charcoal, Bronze, Antique Bronze, Anodic Grey, Slate Grey, Ochre, Sand, Taupe (Set equivalent 11216)	6.36	60.56	576.80							A
11145	Square Smart Fix 60mm Bracket Slotted for Metropole in Chrome (Set equivalent 11216)	11.17	106.42	1013.52							A
11146	Square Smart Fix 80mm Bracket Slotted for Metropole in Silver, Black, White, Matt White, Ecu, Gunmetal, Charcoal, Bronze, Antique Bronze, Anodic Grey, Slate Grey, Ochre, Sand, Taupe (Set equivalent 11217)	6.81	64.89	618.00							A
11146	Square Smart Fix 80mm Bracket Slotted for Metropole in Chrome (Set equivalent 11217)	11.58	110.31	1050.60							A
11147	Square Smart Fix 100mm Bracket Slotted for Metropole in Silver, Black, White, Matt White, Ecu, Gunmetal, Charcoal, Bronze, Antique Bronze, Anodic Grey, Slate Grey, Ochre, Sand, Taupe (Set equivalent 11218)	7.45	70.95	675.68							A
11147	Square Smart Fix 100mm Bracket Slotted for Metropole in Chrome (Set equivalent 11218)	11.99	114.21	1087.68							A
11154	Universal Smart Fix 120mm in White and Silver	17.28	164.60	1567.66							A
11155	Universal Smart Fix 150mm in White and Silver	17.57	167.31	1593.41							A
11156	Universal Smart Fix 200mm in White and Silver	17.95	170.99	1628.43							A
11190	Rail, white and silver in 6 meter lengths						17.50				A
11190	Rail, white and silver cut to size						19.25				A
11190	Rail, matt white, anodic grey, antique bronze and charcoal in 6m lengths						31.24				A
11190	Rail, matt white, anodic grey, antique bronze and charcoal cut to size						34.36				A
11200	Smart Fix 60mm Bracket Set in White and Silver (made up of 11118 + 11116)	6.01	57.25	545.27							A

# Price Index for Rails & Parts

All prices shown  
exclude V.A.T.

Product	Description	Unit Prices					Per Metre Price				Ctgy
		Each	Per 10	Per 100	Other Qty	Price	1m	100m	Other Lgth	Price	
11201	Smart Fix 80mm Bracket Set in White and Silver (made up of 11119 + 11116)	6.78	64.59	615.16							A
11202	Smart Fix 100mm Bracket Set in White and Silver (made up of 11120 + 11116)	6.84	65.13	620.31							A
11203	Smart Fix 120mm Bracket Set in White and Silver (made up of 11121 + 11116)	10.45	99.48	947.42							A
11204	Smart Fix 150mm Bracket Set in White and Silver (made up of 11122 + 11116)	10.60	100.99	961.84							A
11205	Smart Fix 200mm Bracket Set in White and Silver (made up of 11123 + 11116)	11.39	108.51	1033.43							A
11206	Smart Fix 60mm Bracket Slotted for Metropole Bracket Set in Black, Silver, White, Matt White, Ecu, Gunmetal, Charcoal, Bronze, Antique Bronze, Anodic Grey, Slate Grey, Ochre, Sand, Taupe (made up of 11124 + 11116)	6.98	66.44	632.72							A
11206	Smart Fix 60mm Bracket Slotted for Metropole Bracket Set in Chrome (made up of 11124 + 11116)	12.79	121.81	1160.14							A
11207	Smart Fix 80mm Bracket Slotted for Metropole Bracket Set in Black, Silver, White, Matt White, Ecu, Gunmetal, Charcoal, Bronze, Antique Bronze, Anodic Grey, Slate Grey, Ochre, Sand, Taupe (made up of 11125 + 11116)	7.83	74.60	710.49							A
11207	Smart Fix 80mm Bracket Slotted for Metropole Bracket Set in Chrome (made up of 11125 + 11116)	13.30	126.69	1206.55							A
11208	Smart Fix 100mm Bracket Slotted for Metropole Bracket Set in Black, Silver, White, Matt White, Ecu, Gunmetal, Charcoal, Bronze, Antique Bronze, Anodic Grey, Slate Grey, Ochre, Sand, Taupe (made up of 11126 + 11116)	8.79	83.69	797.09							A
11208	Smart Fix 100mm Bracket Slotted for Metropole Bracket Set in Chrome (made up of 11126 + 11116)	15.64	148.99	1418.96							A
11209	Smart Fix Adjustable Metropole Bracket Set in Black, Silver, White, Matt White, Ecu, Gunmetal, Charcoal, Bronze, Antique Bronze, Anodic Grey, Slate Grey, Ochre, Sand, Taupe (made up of 11128 + 11116)	10.93	104.10	991.41							A
11209	Smart Fix Adjustable Metropole Bracket Set in Chrome (made up of 11128 + 11116)	22.26	212.03	2019.35							A
11210	Square Smart Fix 60mm Bracket Set in White and Silver (made up of 11139 + 11137)	10.33	98.42	937.30							A
11211	Square Smart Fix 80mm Bracket Set in White and Silver (made up of 11140 + 11137)	10.88	103.61	986.74							A
11212	Square Smart Fix 100mm Bracket Set in White and Silver (made up of 11141 + 11137)	11.42	108.80	1036.18							A
11213	Square Smart Fix 120mm Bracket Set in White and Silver (made up of 11142 + 11137)	12.07	114.96	1094.89							A
11214	Square Smart Fix 150mm Bracket Set in White and Silver (made up of 11143 + 11137)	12.95	123.29	1174.20							A
11215	Square Smart Fix 200mm Bracket Set in White and Silver (made up of 11144 + 11137)	14.02	133.57	1272.05							A
11216	Square Smart Fix 60mm Bracket Slotted for Metropole Bracket Set in Silver and White (made up of 11145 + 11137)	11.49	109.45	1042.36							A
11216	Square Smart Fix 60mm Bracket Slotted for Metropole Bracket Set in Black, Matt White, Ecu, Gunmetal, Charcoal, Bronze, Antique Bronze, Anodic Grey, Slate Grey, Ochre, Sand, Taupe (made up of 11145 + 11137)	12.88	122.64	1168.02							A
11216	Square Smart Fix 60mm Bracket Slotted for Metropole Bracket Set in Chrome (made up of 11145 + 11137)	21.46	204.40	1946.70							A
11217	Square Smart Fix 80mm Bracket Slotted for Metropole Bracket Set in Silver and White (made up of 11146 + 11137)	11.95	113.77	1083.56							A
11217	Square Smart Fix 80mm Bracket Slotted for Metropole Bracket Set in Black, Matt White, Ecu, Gunmetal, Charcoal, Bronze, Antique Bronze, Anodic Grey, Slate Grey, Ochre, Sand, Taupe (made up of 11146 + 11137)	13.33	126.97	1209.22							A
11217	Square Smart Fix 80mm Bracket Slotted for Metropole Bracket Set in Chrome (made up of 11146 + 11137)	21.87	208.30	1983.78							A
11218	Square Smart Fix 100mm Bracket Slotted for Metropole Bracket Set in Silver and White (made up of 11147 + 11137)	12.58	119.83	1141.24							A
11218	Square Smart Fix 100mm Bracket Slotted for Metropole Bracket Set in Black, Matt White, Ecu, Gunmetal, Charcoal, Bronze, Antique Bronze, Anodic Grey, Slate Grey, Ochre, Sand, Taupe (made up of 11147 + 11137)	13.97	133.02	1266.90							A
11218	Square Smart Fix 100mm Bracket Slotted for Metropole Bracket Set in Chrome (made up of 11147 + 11137)	22.28	212.19	2020.86							A
11230	Recess profile white for 6870 and 3870, white in 6 meter lengths						11.28				A
11230	Recess profile white, for 6870 and 3870, cut to size						12.40				A
11231	Recess profile, white for 6465, white in 6 meter lengths						7.38				A
11231	Recess profile, white for 6465, cut to size						8.12				A
11233	Endcover with screw, white, silver for 6870	6.25	59.54	567.00							A
11233	Endcover with screw, matt white, anodic grey, antique bronze and charcoal	7.41	70.56	672.00							A
11235	Endcover with screw white or silver for 6970	8.42	80.22	764.00							A
11236	Clip			253.14							A
11237	Recess Wedge	0.58									A
11238	Recess Mask for 3870 and 6870	3.04									A
11239	Recess Mask	1.55									A
11260	Gateway	740.00									C
11261	Gateway KNX	890.00									C
11262	Expansion unit	720.00									C
11263	Power supply 24V DC 2 ampere DIN rail	29.16									C

# Price Index for Rails & Parts

All prices shown  
exclude V.A.T.

Product	Description	Unit Prices				Per Metre Price				Ctgy	
		Each	Per 10	Per 100	Other Qty	Price	1m	100m	Other Lgth		Price
11264	Power supply 24V DC 3.8 ampere DIN rail	57.00									C
11265	Power supply 24V DC 5 ampere DIN rail	60.33									C
11266	Power supply 24V DC 10 ampere DIN rail	111.27									C
11270	RS 485 module set white	195.00									C
11281	Cabinet up to 8 shading device unit including circuit breaker protection	1170.00									C
11282	Cabinet up to 24 shading device unit including circuit breaker protection	1508.00									C
11283	Cabinet up to 56 shading device unit including circuit breaker protection	2860.00									C
11285	Guide set white and silver for 3870	27.41	261.00								A
11285	Guide set matt white, anodic grey, antique bronze and charcoal	36.61	348.70								A
11301	2C glider in strip form				1000	254.40					A
11302	Wave 2C glider-cord, 80mm pitch, 50mm rolls only							50m	643.78		A
11303	Wave 2C glider-cord, 60mm pitch, 50mm rolls only							50m	845.63		A
11314	Master carrier for 3970	11.43	108.90								C
11315	Guide set white for 3970	47.97									C
11318	4-Pin connector for 5600 SMART module	9.30									C
11319	4-Pin connector for 5600 SMART motor (motor side)	9.30									C
11320	4-Pin connector for 5600 SMART motor (room side)	13.95									C
11325	6 - Pin connector for Gateway and Expansion unit	10.90									C

# Tools & Packaging

All prices shown  
exclude V.A.T.

Product	Description	Unit Prices					Per Metre Price				Ctgy
		Each	Per 10	Per 100	Other Qty	Price	1m	100m	Other Lgth	Price	
0538	Bending Kit for 7103/7109 incl fillers, blocks, arms and rings for system 3840	161.40									E
0539	Crimping tool	307.15									E
0545	Bending Kit for 7103/7109 incl. fillers, blocks,arms and rings for system 3900	326.01									E
0547	Bending block set (6103)	348.67									E
0587	2.5mm Allen Key for Metropole	0.09									E
0600	Connector tongs for metal chain	60.00									E
0679	Joining pliers for bead chain 4845	123.08									E
0722	2mm Allen Key	0.51									E
7004	Cording needle	1.82									E
7037	Bending fillers 6100	36.84									E
7103	Portable hand operated bending tool for 1080, 3000, 3840/6840, 1280 and 3900, complete with sets of fillers	945.00									E
7109	Portable electrically operated bending tool for 1080, 3000, 3840/6840 1280 and 3900 complete with sets of fillers	1150.00									E
7223	Tongs for connector 2865	386.99									E
7230	Slotting tool for wide channel profiles	113.67									E
7404	Former for 7103/7109 radius 15cm	38.25									E
7432	Bending ring 15cm 1003 for 7103/9	62.67									E
7439	Blocks for 7103/7109 for 6010 profile, 2 required	8.12									E
7550	Centre tool	81.27									E
7802	Filler set 3840 for 7103/9, 200 cm	148.42									E
7803	Filler set 3900 for 7103/9, 200 cm	166.73									E
7803A	Filler set 3900 for 7103/9, 70 cm	87.17									E
7805	Filler set 3000 for 7103/9, 200 cm	263.94									E
7805A	Filler set 3000 for 7103/9, 70 cm	137.01									E
7806	Filler set 1080 for 7103/9, 200 cm	75.88									E
7806A	Filler set 1080 for 7103/9, 70 cm	36.94									E
7844	Filler set 1280 for 7103/9, 70cm	116.68									E
7844A	Filler set 1280 for 7103/9, 200cm	214.84									E
7848	Filler set 1003 for 7103/9, 70cm	42.60									E
7885	Filler set 6010 for 7103/7109, 200cm	168.32									E
10295	Setting lead	30.00									E
10480	Child Safety Device (4.5mm metal to metal bead chain)	9.55									
10481	Child Safety Device (4.5mm plastic to plastic bead chain)	9.55									
10482	Child Safety Device (4mm metal to metal bead chain)	9.55									
10537	Joining pliers for 10530 chain (4910)	66.22									E
11269	Hand held setting tool for Series 40 and SMART motors (TTPRO)	100.00									E
80018	Slotting tool	448.48									E
B5	Bending block for 6100	419.12									E
SF	Silicone fluid, litre	53.53									E
SL1080	Sleeving 1080, reel	28.65									E
SL1080W	Sleeving 1080W, reel	41.23									E
SL1090	Sleeving 1090, reel	35.87									E
SL1090W	Sleeving 1090W, reel	40.34									E
SL3000	Sleeving 3000, reel	45.15									E
SL3000W	Sleeving 3000W, reel	52.28									E
SLP	Sleeving plain 2" x 300 gauge, reel	19.36									E
HTSAL	Top s/a label		45.06								E
HBSAL	Bottom s/a label		32.19								E
CIAL	Colour indication s/a label (mixed - please specify)		4.83								E
CSIAL	Size indication s/a label (mixed - please specify)		4.83								E
HINL	Instruction leaflet		14.54								E
HCPA	38mm x 38mm acetate sleeving, roll										E
HWPE	White plastic endcaps				pair	1.90					E
CTSAL	Top s/a label		45.06								E
CBSAL	Bottom s/a label		39.69								E
CINL	Instruction leaflet		14.54								E
CCPA	35mm x 50mm acetate sleeving, roll	1.05									E
CWPE	White plastic endcaps				pair	1.90					E
Labour	To fully assemble cabinet with SMART Gateway, expansion unit (if required) and power supplies:										
	Up to 8 systems (Labour cost only)	102.70									E
	Up to 24 systems (Labour cost only)	166.40									E
	Up to 56 systems (Labour cost only)	188.50									E

## Application Chart for Silent Gliss® Switches, Remote Control and Multiple Operation of Motorised Systems

Motor Number	Fixed Switch (Hard wired)	Radio Control System 0450		Radio Control System 9940			*SMART	Timer and Controls	System
		Hand Held Remotes	Wall Switches	Move Server Set	Hand Held Remotes	Wall Switches & Light Sensors	Via Gateway		
2160	0615/6/7/8/9 Latching	Remote 0915/0939 Receiver 0919	Wall Switch 0913/0914 Receiver 0919	9960, 9961	Remote 10300/10302/10303/10804 Receiver 9068/9945	Wall Switch 9946/9948 Light Sensor 10297 Receiver 9068/9944/9945	n/a	9952 9953	<b>2195</b>
10322/ 10522/ 11241/ 11244	Motor 10522/10322 0615/6/7/8/9 Latching	Motor 10322/10522 Remote 0915/0939 Receiver 0919	Motor 10322/10522 Wall Switch 0913/0914 Receiver 0919	9960, 9961	Motor 10323/10523 Remote 10300/10302/10303/10804 Receiver Integrated	Motor 10323/10523 Wall Switch 9946/9948 Light Sensor 10297 Receiver Integrated	11251	9952 9953	<b>2350</b>
9090/ 9091/ 9091EL	Motor 9090 0613 5 Position	Motor 9091 Remote 0915/0939 Receiver Integrated	Motor 9091 Wall Switch 0913/0914 Receiver Integrated	9960, 9961	Motor 9091EL Remote 10300/10302/10303/10804 Receiver Integrated	Motor 9091EL Wall Switch 9946/9948 Light Sensor 10297 Receiver Integrated	n/a	n/a	<b>2950</b>
10522/ 11241/ 11244	Motor 10522 0615/6/7/8/9 Latching	Motor 10522 Remote 0915/0939 Receiver 0919	Motor 10522 Wall Switch 0913/0914 Receiver 0919	9960, 9961	Motor 10523 Remote 10300/10302/10303/10804 Receiver Integrated	Motor 10523 Wall Switch 9946/9948 Light Sensor 10297 Receiver Integrated	11251	9952 9953	<b>4760</b>
10522/ 11241/ 11244	Motor 10522 0615/6/7/8/9 Latching	Motor 10522 Remote 0915/0939 Receiver 0919	Motor 10522 Wall Switch 0913/0914 Receiver 0919	9960, 9961	Motor 10523 Remote 10300/10302/10303/10804 Receiver Integrated	Motor 10523 Wall Switch 9946/9948 Light Sensor 10297 Receiver Integrated	11251	9952 9953	<b>4770</b>
10522/ 11241/ 11244	Motor 10522 0615/6/7/8/9 Latching	Motor 10522 Remote 0915/0939 Receiver 0919	Motor 10522 Wall Switch 0913/0914 Receiver 0919	9960, 9961	Motor 10523 Remote 10300/10302/10303/10804 Receiver Integrated	Motor 10523 Wall Switch 9946/9948 Light Sensor 10297 Receiver Integrated	11251	9952 9953	<b>4780</b>
4960 LV	10692 (0631)	n/a	n/a	n/a	n/a	n/a	n/a	n/a	<b>4960 LV</b>
10320/ 11240	Motor 10320 0615/6/7/8/9 Latching	Motor 10320 Remote 0915/0939 Receiver 0919	Motor 10320 Wall Switch 0913/0914 Receiver 0919	9960, 9961	Motor 10321 Remote 10300/10302/10303 Receiver Integrated	Motor 10321 Wall Switch 9946/9948 Light Sensor 10297 Receiver Integrated	11250	9952 9953	<b>4960</b>
10522/ 11241/ 11244	Motor 10522 0615/6/7/8/9 Latching	Motor 10522 Remote 0915/0939 Receiver 0919	Motor 10522 Wall Switch 0913/0914 Receiver 0919	9960, 9961	Motor 10523 Remote 10300/10302/10303 Receiver Integrated	Motor 10523 Wall Switch 9946/9948 Light Sensor 10297 Receiver Integrated	11251	9952 9953	<b>4970</b>
10326/ 11248/ 11249	Motor 10326 0615/6/7/8/9 Latching	Motor 10326 Remote 0915/0939 Receiver 0919	Motor 10326 Wall Switch 0913/0914 Receiver 0919	9960, 9961	Motor 10327 Remote 10300/10302/10303 Receiver Integrated	Motor 10327 Wall Switch 9946/9948 Light Sensor 10297 Receiver Integrated	11255	9952 9953	<b>4880</b>
5190	n/a	n/a	n/a	n/a	n/a	n/a	n/a	10949	<b>5100B</b>
5190	n/a	n/a	n/a	n/a	n/a	n/a	n/a	10946 10949	<b>5100R</b>
5190	n/a	n/a	n/a	n/a	n/a	n/a	n/a	10949 11092	<b>5100T</b>

\*Refer to page 28 for SMART components

## Application Chart for Silent Gliss® Switches, Remote Control and Multiple Operation of Motorised Systems

Motor Number	Fixed Switch (Hard wired)	Radio Control System 0450			Radio Control System 9940			SMART	Timer and Controls	System
		Hand Held Remotes	Wall Switches	Move Server Set	Hand Held Remotes	Wall Switches & Light Sensors	Via Gateway			
5190	n/a	n/a	n/a	n/a	n/a	n/a	n/a	10949 11092 10946	<b>5100TC</b>	
5360	0565/6/7/8/9 Non latching	Remote 0915/0939 Receiver 0270	Wall Switch 0913/0914 Receiver 0918	9960, 9961	Remote 10300/10302/10303/ 10804 Receiver 9068	Wall Switch 9946/9948 Light Sensor 10297 Receiver 9068	n/a	9952	<b>5300</b>	
9060	Motor 9060 0615/6/7/8/9	Motor 9060 Remote 0915/0939 Receiver Integrated	Motor 9060 Wall Switch 0913/0914 Receiver Integrated	9960, 9961	Motor 9060 Remote 10300/10302/10303/ 10804 Receiver Integrated	Motor 9060 Wall Switch 9946/9948 Light Sensor 10297 Receiver Integrated	11270	9952	<b>5600</b>	
5805	0615/6/7/8/9 Latching	Remote 0915/0939 Receiver 0919	Wall Switch 0913/0914 Receiver 0919	9960, 9961	Remote 10300/10302/10303/ 10804 Receiver 9068/9944/9945	Wall Switch 9946/9948 Light Sensor 10297 Receiver 9068/9944/9945	n/a	n/a	<b>5800</b>	
8060	0928/0937 5 Position	Remote 0915/0939 Receiver 0907 (Pulse enabled)	Wall Switch 0913/0914 Receiver 0907 (Pulse Enabled)	9960, 9961	Remote 10300/10302/10303/ 10804 Receiver 9068/9947	Wall Switch 9946/9948 Light Sensor 10297 Receiver 9068/9947	n/a	n/a	<b>8250</b>	
8060				9960, 9961	Remote 10300/10302/10303/ 10804 Receiver 9068/9947	Wall Switch 9946/9948 Light Sensor 10297 Receiver 9068/9947	n/a	n/a	<b>8500</b>	
8605	0615/6/7/8/9 Latching	Remote 0915/0939 Receiver 0919	Wall Switch 0913/0914 Receiver 0919	9960, 9961	Remote 10300/10302/10303/ 10804 Receiver 9068/9944/9945	Wall Switch 9946/9948 Light Sensor 10297 Receiver 9068/9944/9945	n/a	9952 9953	<b>8600</b>	
	0615/6/7/8/9 Latching	Remote 0915/0939 Receiver 0919	Wall Switch 0913/0914 Receiver 0919	9960, 9961	Remote 10300/10302/10303/ 10804 Receiver 9068/9944/9945	Wall Switch 9946/9948 Light Sensor 10297 Receiver 9068/9944/9945	n/a	9952 9953	<b>8640</b>	
11095 11096	0613 5 Position	Remote 0915/0939 Receiver 0919 (Pulse enabled)	Wall Switch 0913/0914 Receiver 0919 (Pulse enabled)	9960, 9961	Remote 10300/10302/10303/ 10804 Receiver integrated	Wall Switch 9946/9948 Light Sensor 10297 Receiver integrated	n/a	9953	<b>8960</b>	

## Battery Operated Blinds Application Chart for Remote Control Switches and Wall Plates

Motor	Hard wired switch	Wall Plates	Hand held Remotes	Move Server Set	9940	0450	SMART	Timer and Controls	
11076	n/a	10949, 10950, 10951	10946, 10947, 10948	n/a	n/a	n/a	n/a	11092	<b>4955</b>
11076	n/a	10949, 10950, 10951	10946, 10947, 10948	n/a	n/a	n/a	n/a	11092	<b>2345</b>



For motor types and connections see wiring diagrams.



# Terms & Conditions of Trading with Silent Gliss Ltd

The buyer's attention is in particular drawn to the provisions of condition 12.4.

## 1. INTERPRETATION

1.1 The definitions and rules of interpretation in this condition apply in these conditions.

**Buyer:** the person, firm or company who purchases the Goods and/or Services from the Company.

**Company:** Silent Gliss Ltd.

**Contract:** any contract between the Company and the Buyer for the sale and purchase of the Goods and/or provision of Services, incorporating these conditions.

**Delivery Point:** the place where delivery of the Goods is to take place under condition 4.

**Goods:** any goods agreed in the Contract to be supplied to the Buyer by the Company (including any part or parts of them).

**Services:** any installation services agreed in the Contract to be supplied to the Buyer by the Company.

1.2 A reference to a particular law is a reference to it as it is in force for the time being taking account of any amendment, extension, application or re-enactment and includes any subordinate legislation for the time being in force made under it.

1.3 Words in the singular include the plural and in the plural include the singular.

1.4 A reference to one gender includes a reference to the other gender.

1.5 Condition headings do not affect the interpretation of these conditions.

## 2. APPLICATION OF TERMS

2.1 Subject to any variation under condition 2.3 the Contract shall be on these conditions to the exclusion of all other terms and conditions (including any terms or conditions which the Buyer purports to apply under any purchase order, confirmation of order, specification or other document).

2.2 No terms or conditions endorsed on, delivered with or contained in the Buyer's purchase order, confirmation of order, specification or other document shall form part of the Contract simply as a result of such document being referred to in the Contract.

2.3 These conditions apply to all the Company's sales and any variation to these conditions and any representations about the Goods and/or Services shall have no effect unless expressly agreed in writing and signed by the Sales Director of the Company. The Buyer acknowledges that it has not relied on any statement, promise or representation made or given by or on behalf of the Company which is not set out in the Contract. Nothing in this condition shall exclude or limit the Company's liability for fraudulent misrepresentation.

2.4 Each order or acceptance of a quotation for Goods and/or Services from the Company shall be deemed to be an offer by the Buyer to buy Goods and/or Services subject to these conditions.

2.5 No order placed by the Buyer shall be deemed to be accepted by the Company until a written acknowledgement of order is issued by the Company or (if earlier) the Company delivers the Goods to and/or carries out the Services for the Buyer.

2.6 The Buyer shall ensure that the terms of its order and any applicable specification are complete and accurate.

2.7 Any quotation is given on the basis that no Contract shall come into existence until the Company despatches an acknowledgement of order to the Buyer. Any quotation is valid for a period of 60 days only from its date, provided that the Company has not previously withdrawn it.

## 3. DESCRIPTION

3.1 The quantity and description of the Goods and/or Services shall be as set out in the Company's quotation or acknowledgement of order.

3.2 All samples, drawings, descriptive matter, specifications and advertising issued by the Company and any descriptions or illustrations contained in the Company's catalogues or brochures are issued or published for the sole purpose of giving an approximate idea of the Goods described in them. They shall not form part of the Contract and this is not a sale by sample.

## 4. DELIVERY

4.1 Unless otherwise agreed in writing by the Company, delivery of the Goods shall take place at the time the Goods have been unloaded at the delivery address nominated by the Buyer.

4.2 The Buyer shall take delivery of the Goods within 30 days of the Company giving it notice that the Goods are ready for delivery.

4.3 Any dates specified by the Company for delivery of the Goods or commencement or duration for performance of the Services are intended to be an estimate and time for delivery and/or performance shall not be made of the essence by notice. If no dates are so specified, delivery and/or performance shall be within a reasonable time.

4.4 Subject to the other provisions of these conditions the Company shall not be liable for any direct, indirect or consequential loss (all three of which terms include, without limitation, pure economic loss, loss of profits, loss of business, depletion of goodwill and similar loss), costs, damages, charges or expenses caused directly or indirectly by any delay in the delivery of the Goods or performance of the Services (even if caused by the Company's negligence), nor shall any delay entitle the Buyer to terminate or rescind the Contract unless such delay exceeds 60 days.

4.5 If for any reason the Buyer fails to accept delivery of any of the Goods when they are ready for delivery, or the Company is unable to deliver the Goods on time because the Buyer has not provided appropriate instructions, documents, licences or authorisations:

- (a) risk in the Goods shall pass to the Buyer (including for loss or damage caused by the Company's negligence);
- (b) the Goods shall be deemed to have been delivered; and
- (c) the Company may store the Goods until delivery, whereupon the Buyer shall be liable for all related costs and expenses (including, without limitation, storage and insurance).

4.6 If the Company delivers to the Buyer a quantity of Goods of up to 5% more or less than the quantity accepted by the Company, the Buyer shall not be entitled to object to or reject the Goods or any of them by reason of the surplus or shortfall and shall pay for such goods at the pro rata Contract rate.

4.7 The Company may deliver the Goods by separate instalments. Each separate instalment shall be invoiced and paid for in accordance with the provisions of the Contract.

4.8 Each instalment shall be a separate Contract and no cancellation or termination of any one Contract relating to an instalment shall entitle the Buyer to repudiate or cancel any other Contract or instalment.

## 5. CANCELLATIONS AND RETURNS

The Buyer shall not be entitled to cancel any Contract or return Goods for refund without the prior written consent of the Company (which will be the absolute discretion of the Company) and payment of a handling charge of 20% of the Price in respect of ex stock items and in the case of made-to-measure items a percentage of the Price dependent upon the stage of manufacture reached at the point of cancellation.

## 6. NON-DELIVERY

6.1 The quantity of any consignment of Goods as recorded by the Company upon despatch from the Company's place of business shall be conclusive evidence of the quantity received by the Buyer on delivery unless the Buyer can provide conclusive evidence proving the contrary.

6.2 The Company shall not be liable for any non-delivery of Goods (even if caused by the Company's negligence) unless the Buyer gives written notice to the Company of the non-delivery within 7 days of the date when the Goods would in the ordinary course of events have been received.

6.3 Any liability of the Company for non-delivery of the Goods shall be limited to replacing the Goods within a reasonable time or issuing a credit note at the pro rata Contract rate against any invoice raised for such Goods.

## 7. INSTALLATION

7.1 All costs in relation to Installation by the Company shall be payable by the Buyer in addition to the price of the Goods. The following standard charges apply (duration of each installation is dependent on the type of work being carried out):

- £350 + VAT per day (per engineer)
- £250 + VAT per ½ day (per engineer)
- £220 + VAT Service Callout (parts not included)

7.2 The Buyer shall be solely responsible for ensuring that its site and adequate and safe access thereto is ready for installation of the Goods. Fixing points must be adequate for the proper and secure installation of the Goods. The Buyer must pay for the cost of any modification to its site or the Goods that is required to enable the Goods to be properly installed.

- 7.3 The Buyer shall be solely responsible for all ancillary work required and costs incurred in connection with installation of Goods, including (without limitation) access, scaffolding hire, electrical work, decorating, or making good.
- 7.4 The Buyer shall advise the Company of any hidden obstruction (including without limitation, electricity, telephone and other communications cables and water, gas and drainage pipes) that may be encountered during installation of the Goods. The Company will not be liable for any damage to any structure, surface or service. The Buyer will pay all costs incurred by the Company in consequence of any damage to any hidden obstruction and will indemnify the Company against all liability, loss, cost and expense that it incurs arising out of or in consequence of installation of the Goods or damage to any structure, surface or service.
- 7.5 At all times, suppliers must comply with the Regulations. The Regulations provide that the Suppliers performing the installation services must fit any safety device supplied with the Goods.
- (a) In the event that the Customer should refuse to allow the Supplier to fit any such safety device accompanying the Goods, then the Supplier will be at liberty to refuse to carry out the Services. In such instance, the Customer will still be liable to pay the Supplier the Price in full under the Contract.
- (b) The Customer shall not be entitled to treat the Suppliers refusal to carry out any Services in relation to the Goods for the reasons set out in this clause 7.4 as a fundamental or any breach of contract. The Customer will still be bound under the Contract to take delivery of the Goods.
- 7.6 The parties to the contract consider the provisions of this clause 7.4 to be reasonable under all the circumstances given the Supplier's obligations under the Regulations.
- 8. RISK/TITLE**
- 8.1 The Goods are at the risk of the Buyer from the time of delivery.
- 8.2 Ownership of the Goods shall not pass to the Buyer until the Company has received in full (in cash or cleared funds) all sums due to it in respect of:
- (a) the Goods; and
- (b) all other sums which are or which become due to the Company from the Buyer on any account.
- 8.3 Until ownership of the Goods has passed to the Buyer, the Buyer shall:
- (a) hold the Goods on a fiduciary basis as the Company's bailee;
- (b) store the Goods (at no cost to the Company) separately from all other goods of the Buyer or any third party in such a way that they remain readily identifiable as the Company's property;
- (c) not destroy, deface or obscure any identifying mark or packaging on or relating to the Goods; and
- (d) maintain the Goods in satisfactory condition and keep them insured on the Company's behalf for their full price against all risks to the reasonable satisfaction of the Company. On request the Buyer shall produce the policy of insurance to the Company.
- 8.4 The Buyer may resell the Goods before ownership has passed to it solely on the following conditions:
- (a) any sale shall be effected in the ordinary course of the Buyer's business at full market value; and
- (b) any such sale shall be a sale of the Company's property on the Buyer's own behalf and the Buyer shall deal as principal when making such a sale.
- 8.5 The Buyer's right to possession of the Goods shall terminate immediately if:
- (a) the Buyer has a bankruptcy order made against him or makes an arrangement or composition with his creditors, or otherwise takes the benefit of any statutory provision for the time being in force for the relief of insolvent debtors, or (being a body corporate) convenes a meeting of creditors (whether formal or informal), or enters into liquidation (whether voluntary or compulsory) except a solvent voluntary liquidation for the purpose only of reconstruction or amalgamation, or has a receiver and/or manager, administrator or administrative receiver appointed of its undertaking or any part thereof, or documents are filed with the court for the appointment of an administrator of the Buyer or notice of intention to appoint an administrator is given by the Buyer or its directors or by a qualifying floating charge holder (as defined in paragraph 14 of Schedule B1 to the Insolvency Act 1986), or a resolution is passed or a petition presented to any court for the winding-up of the Buyer or for the granting of an administration order in respect of the Buyer, or any proceedings are commenced relating to the insolvency or possible insolvency of the Buyer; or
- (b) the Buyer suffers or allows any execution, whether legal or equitable, to be levied on his/its property or obtained against him/it, or fails to observe or perform any of his/its obligations under the Contract or any other contract between the Company and the Buyer, or is unable to pay its debts within the meaning of section 123 of the Insolvency Act 1986 or the Buyer ceases to trade; or
- (c) the Buyer encumbers or in any way charges any of the Goods.
- 8.6 The Company shall be entitled to recover payment for the Goods notwithstanding that ownership of any of the Goods has not passed from the Company.
- 8.7 The Buyer grants the Company, its agents and employees an irrevocable licence at any time to enter any premises where the Goods are or may be stored in order to inspect them, or, where the Buyer's right to possession has terminated, to recover them.
- 8.8 Where the Company is unable to determine whether any Goods are the goods in respect of which the Buyer's right to possession has terminated, the Buyer shall be deemed to have sold all goods of the kind sold by the Company to the Buyer in the order in which they were invoiced to the Buyer.
- 8.9 On termination of the Contract, howsoever caused, the Company's (but not the Buyer's) rights contained in this condition 8 shall remain in effect.
- 9. PRICE**
- 9.1 Unless otherwise agreed by the Company in writing, the price for the Goods and/or Services shall be the price set out in the Company's price list published on the date of delivery or deemed delivery.
- 9.2 The price for the Goods and/or Services shall be exclusive of any value added tax.
- 9.3 All costs or charges in relation to carriage and insurance during transit shall be payable by the Buyer in addition to the price of the Goods when it is due to pay for the Goods where the price of the Goods in any Contract is less than £150 before value-added tax, and in all other cases such costs or charges shall be borne by the Company.
- 9.4 For shipments outside UK mainland, i.e. Highlands, Channel Islands, the Company reserves the right to charge a delivery supplement.
- 10. PAYMENT**
- 10.1 Subject to condition 10.4, payment of the price for the Goods is due in pounds sterling on the last working day of the month following the month in which the Goods are delivered or deemed to be delivered and/or the services are performed.
- 10.2 Time for payment shall be of the essence.
- 10.3 No payment shall be deemed to have been received until the Company has received cleared funds.
- 10.4 All payments payable to the Company under the Contract shall become due immediately on its termination despite any other provision.
- 10.5 The Buyer shall make all payments due under the Contract in full without any deduction whether by way of set-off, counterclaim, discount, abatement or otherwise unless the Buyer has a valid court order requiring an amount equal to such deduction to be paid by the Company to the Buyer.
- 10.6 If the Buyer fails to pay the Company any sum due pursuant to the Contract, the Buyer shall be liable to pay interest to the Company on such sum from the due date for payment at the annual rate of 1.5% per month, accruing on a daily basis until payment is made, whether before or after any judgment.
- 11. QUALITY**
- 11.1 The Company warrants that (subject to the other provisions of these conditions):
- (a) upon delivery, and for a period of five years from the date of delivery the Goods shall
- (i) be of satisfactory quality within the meaning of the Sale of Goods Act 1979;
- (ii) be reasonably fit for purpose; and
- (b) the Services shall be performed with reasonable skill and care.
- (c) This warranty applies to hardware only. Fabric is subject to suppliers' guarantees.
- 11.2 The Company shall not be liable for a breach of any of the warranties in condition 11.1 unless:
- (a) the Buyer gives written notice of the defect to the Company, and, if the defect is as a result of damage in transit to the carrier, within 7 days of the time when the Buyer discovers or ought to have discovered the defect;
- (b) where the contract is for supply only of Goods the Company is given a reasonable opportunity after receiving the notice of

- examining the Goods and the Buyer (if asked to do so by the Company) returns such Goods to the Company's place of business at the Company's cost for the examination to take place there; and
- (c) where the Contract is for supply and installation of Goods the Company is given a reasonable opportunity after receiving notice of examining the Goods and their installation on site.
- 11.3 The Company shall not be liable for a breach of any of the warranties in condition 11.1 if:
- the Buyer makes any further use of such Goods after giving such notice; or
  - the defect arises because the Buyer failed to follow the Company's oral or written instructions as to the storage, installation, commissioning, use or maintenance of the Goods or (if there are none) good trade practice; or
  - the Buyer alters or repairs such Goods without the written consent of the Company.
- 11.4 Subject to condition 11.2 and condition 11.3, if any of the Goods and/or Services do not conform with any of the warranties in condition 11.1 the Company shall
- if the Contract is for supply only of Goods, at its option repair or replace such Goods (or the defective part) or refund the price of such Goods at the pro rata Contract rate provided that, if the Company so requests, the Buyer shall, at the Company's expense, return the Goods or the part of such Goods which is defective to the Company;
  - if the Contract includes installation of Goods by the Company, the Services shall be reperformed by the Company on site until such Services are in conformity or at the Company's option it may pay for the Services to be performed again.
- 11.5 If the Company complies with condition 11.4 it shall have no further liability for a breach of any of the warranties in condition 11.1 in respect of such Goods and/or Services.
- 11.6 Any Goods replaced shall belong to the Company and any repaired or replacement Goods shall be guaranteed on these terms for the unexpired portion of the five year period.
- 11.7 The Buyer is responsible for ensuring the suitability of and absence from manufacturing flaws in any fabric supplied by the Buyer and for marking any such flaws. The Company is not responsible for the performance of any fabric supplied by the Buyer, including (without limitation) its adhesive capabilities when attaching bond cloth, shrinkage, matching of patterns and manufacture into roller blinds. The Buyer is responsible for all fabric and labour costs of remedying fabric flaws discovered by the Company in the course of manufacturing the Goods.
- 12. LIMITATION OF LIABILITY**
- 12.1 Subject to condition 4, condition 6 and condition 11, the following provisions set out the entire financial liability of the Company (including any liability for the acts or omissions of its employees, agents and sub-contractors) to the Buyer in respect of:
- any breach of these conditions;
  - any use made or resale by the Buyer of any of the Goods, or of any product incorporating any of the Goods; and
  - any representation, statement or tortious act or omission including negligence arising under or in connection with the Contract.
- 12.2 All warranties, conditions and other terms implied by statute or common law (save for the conditions implied by section 12 of the Sale of Goods Act 1979) are, to the fullest extent permitted by law, excluded from the Contract.
- 12.3 Nothing in these conditions excludes or limits the liability of the Company:
- for death or personal injury caused by the Company's negligence; or
  - under section 2(3), Consumer Protection Act 1987; or
  - for any matter which it would be illegal for the Company to exclude or attempt to exclude its liability; or
  - for fraud or fraudulent misrepresentation.
- 12.4 Subject to condition 12.2 and condition 12.3:
- the Company's total liability in contract, tort (including negligence or breach of statutory duty), misrepresentation, restitution or otherwise, arising in connection with the performance or contemplated performance of the Contract shall be limited to the Contract price; and
  - the Company shall not be liable to the Buyer for any pure economic loss, loss of profit, loss of business, depletion of goodwill or otherwise, in each case whether direct, indirect or consequential, or any claims for consequential compensation whatsoever (howsoever caused) which arise out of or in connection with the Contract.
- 13. ASSIGNMENT**
- 13.1 The Company may assign the Contract or any part of it to any person, firm or company.
- 13.2 The Buyer shall not be entitled to assign the Contract or any part of it without the prior written consent of the Company.
- 14. FORCE MAJEURE**
- The Company reserves the right to defer the date of delivery or to cancel the Contract or reduce the volume of the Goods ordered by the Buyer (without liability to the Buyer) if it is prevented from or delayed in the carrying on of its business due to circumstances beyond the reasonable control of the Company including, without limitation, acts of God, governmental actions, war or national emergency, acts of terrorism, protests, riot, civil commotion, fire, explosion, flood, epidemic, lock-outs, strikes or other labour disputes (whether or not relating to either party's workforce), or restraints or delays affecting carriers or inability or delay in obtaining supplies of adequate or suitable materials, provided that, if the event in question continues for a continuous period in excess of 60 days, the Buyer shall be entitled to give notice in writing to the Company to terminate the Contract.
- 15. GENERAL**
- 15.1 Each right or remedy of the Company under the Contract is without prejudice to any other right or remedy of the Company whether under the Contract or not.
- 15.2 If any provision of the Contract is found by any court, tribunal or administrative body of competent jurisdiction to be wholly or partly illegal, invalid, void, voidable, unenforceable or unreasonable it shall to the extent of such illegality, invalidity, voidness, voidability, unenforceability or unreasonableness be deemed severable and the remaining provisions of the Contract and the remainder of such provision shall continue in full force and effect.
- 15.3 Failure or delay by the Company in enforcing or partially enforcing any provision of the Contract shall not be construed as a waiver of any of its rights under the Contract.
- 15.4 Any waiver by the Company of any breach of, or any default under, any provision of the Contract by the Buyer shall not be deemed a waiver of any subsequent breach or default and shall in no way affect the other terms of the Contract.
- 15.5 The parties to the Contract do not intend that any term of the Contract shall be enforceable by virtue of the Contracts (Rights of Third Parties) Act 1999 by any person that is not a party to it.
- 15.6 The formation, existence, construction, performance, validity and all aspects of the Contract shall be governed by English law and the parties submit to the exclusive jurisdiction of the English courts.
- 16. COMMUNICATIONS**
- 16.1 All communications between the parties about the Contract shall be in writing and delivered by hand or sent by pre-paid first class post or sent by fax:
- (in case of communications to the Company) to its registered office or such changed address as shall be notified to the Buyer by the Company; or
  - (in the case of the communications to the Buyer) to the registered office of the addressee (if it is a company) or (in any other case) to any address of the Buyer set out in any document which forms part of the Contract or such other address as shall be notified to the Company by the Buyer.
- 16.2 Communications shall be deemed to have been received:
- if sent by pre-paid first class post, two days (excluding Saturdays, Sundays and bank and public holidays) after posting (exclusive of the day of posting); or
  - if delivered by hand, on the day of delivery; or
  - if sent by fax on a working day prior to 4.00 pm, at the time of transmission and otherwise on the next working day.
- 16.3 Communications addressed to the Company shall be marked for the attention of the Sales Director.



## *The Architects of Silence*

*Silent Gliss is the leading global supplier of premium interior window treatment systems.*

*With cutting edge technology and a relentless commitment to precision, we develop and manufacture the world's quietest, smoothest-gliding curtains and blinds.*

*Driven by our customers' needs, Silent Gliss provides bespoke curtain and blind systems complemented by expert technical advice, installation and support services. Silent Gliss stands for innovative solutions, exceptional design and outstanding quality. Swiss engineered since 1952.*

**Silent Gliss Ltd.**  
Pyramid Business Park  
Poorhole Lane, Broadstairs  
Kent CT10 2PT  
United Kingdom  
T +44 1843 863571  
F +44 1843 864503  
info@silentgliss.co.uk

**silentgliss.co.uk**